



Water quality permitting: From end-of-pipe to operational strategies



Fanlin Meng, Guangtao Fu*, David Butler

Centre for Water Systems, College of Engineering, Mathematics and Physical Sciences, University of Exeter, Exeter, EX4 4QF, UK

ARTICLE INFO

Article history:

Received 18 February 2016

Received in revised form

16 May 2016

Accepted 24 May 2016

Available online 27 May 2016

Keywords:

Integrated modelling

Multi-objective optimisation

Stakeholder engagement

Urban wastewater system

Water quality permitting

ABSTRACT

End-of-pipe permitting is a widely practised approach to control effluent discharges from wastewater treatment plants. However, the effectiveness of the traditional regulation paradigm is being challenged by increasingly complex environmental issues, ever growing public expectations on water quality and pressures to reduce operational costs and greenhouse gas emissions. To minimise overall environmental impacts from urban wastewater treatment, an operational strategy-based permitting approach is proposed and a four-step decision framework is established: 1) define performance indicators to represent stakeholders' interests, 2) optimise operational strategies of urban wastewater systems in accordance to the indicators, 3) screen high performance solutions, and 4) derive permits of operational strategies of the wastewater treatment plant. Results from a case study show that operational cost, variability of wastewater treatment efficiency and environmental risk can be simultaneously reduced by at least 7%, 70% and 78% respectively using an optimal integrated operational strategy compared to the baseline scenario. However, trade-offs exist between the objectives thus highlighting the need of expansion of the prevailing wastewater management paradigm beyond the narrow focus on effluent water quality of wastewater treatment plants. Rather, systems thinking should be embraced by integrated control of all forms of urban wastewater discharges and coordinated regulation of environmental risk and treatment cost effectiveness. It is also demonstrated through the case study that permitting operational strategies could yield more environmentally protective solutions without entailing more cost than the conventional end-of-pipe permitting approach. The proposed four-step permitting framework builds on the latest computational techniques (e.g. integrated modelling, multi-objective optimisation, visual analytics) to efficiently optimise and interactively identify high performance solutions. It could facilitate transparent decision making on water quality management as stakeholders are involved in the entire process and their interests are explicitly evaluated using quantitative metrics and trade-offs considered in the decision making process. We conclude that the operational strategy-based permitting shows promising for regulators and water service providers alike.

© 2016 The Author(s). Published by Elsevier Ltd. This is an open access article under the CC BY license (<http://creativecommons.org/licenses/by/4.0/>).

1. Introduction

Permitting is a widely practised approach to control environmental risk imposed by activities with non-negligible (water, gas or solid) waste emissions. Urban wastewater discharges to the environment are strictly and routinely regulated by setting quality and/or quantity limits on the effluent from wastewater systems based on treatment technology and estimation of the impact to the environment (U.S. Environmental Protection Agency, 2010a; Environment Agency, 2011). As protection of the aquatic environment has become more highly valued and understood, permits to

discharge have become more demanding, more comprehensive but also more costly. For example, the UK water industry expects to invest £27 billion (\$46 billion) between 2010 and 2030 (Severn Trent Water Limited, 2013) to install additional treatment capacity (e.g. biological, adsorption or ultrafiltration processes for the removal of metals, pharmaceuticals, nutrients and ammonia etc.) (Georges et al., 2009) to meet the requirements of “good status” of the European Water Framework Directive (WFD) (European Parliament and Council of the European Union, 2000). In addition to the financial burden, enhanced treatment (e.g. increased aeration or carbon source addition, and treatment process extension) can increase Greenhouse Gas (GHG) emissions (Flores-Alsina et al., 2011; Georges et al., 2009; Sweetapple et al., 2014a, 2014b) thus contributing to climate change. The increased wastewater treatment under the WFD is estimated to increase CO₂ emissions by over

* Corresponding author.

E-mail address: g.fu@exeter.ac.uk (G. Fu).

110,000 tonnes per year in the UK (Georges et al., 2009). As such, it is difficult to comply with a stricter effluent permit without raising GHG emissions (and cost) by the conventional strategy of enlarging capacity of the existing treatment processes.

In contrast to the strict regulation of effluent discharges from wastewater treatment plants (WWTPs), spills of untreated wastewater from Combined Sewer Overflows (CSOs) are separately controlled by simple measures such as spill frequency (U.S. Environmental Protection Agency, 1995; Environment Agency, 2011), even though the highly concentrated wastewater spills have an acute toxic effect and can be lethal to the aquatic community (Kay et al., 2008; Weyrauch et al., 2010; Phillips et al., 2012). Indeed, research has clearly shown the poor correlation between reducing CSO spill frequency or volume and improving receiving water quality (Lau et al., 2002). It was estimated that some 8000 of approximately 25,000 CSOs in England and Wales were causing water problems at the beginning of the 1990s (Clifforde et al., 2006) and many remain underperforming even today (Nardell, 2012). The investment needed to improve CSOs is considerable, e.g. £2.9 billion (\$4.9 billion) was estimated for the UK (Clifforde et al., 2006) and £26.5 billion (\$45 billion) for the USA (U.S. Environmental Protection Agency, 1999).

To address urban water pollution in a more sustainable manner, flexible permitting approaches have been introduced to encourage cost-effective, risk reduction solutions as compared with conventional end-of-pipe permitting approaches. Examples are integrated permitting of wet weather discharges from sewer systems (U.S. Environmental Protection Agency, 2007), and water quality trading between a WWTP effluent discharge and other pollution source(s) in the same catchment to attain cheaper and environmentally equivalent or superior pollutant reductions (U.S. Environmental Protection Agency, 2007; Selman et al., 2009). Despite the progress achieved so far in integrated wastewater governance, regulation of WWTP effluent discharges and CSOs is still fragmented which contributes to the poorly coordinated management of the sewer system and the WWTP. For example, operational strategies of the sewer system are often developed to minimise the volume of wastewater spill and retain for treatment with limited account of the capacity of the WWTP (U.S. Environmental Protection Agency, 1995). Likewise, technological measures targeted at the WWTP, such as resource recovery and recycling schemes (Guest et al., 2009; Mccarty et al., 2011; Jin et al., 2015), innovative wastewater treatment technologies (Strous et al., 1997; U.S. Environmental Protection Agency, 2013; Castro-Barros et al., 2015) and efficient operation and control techniques (Thornton et al., 2010; Sweetapple et al., 2014a), are developed with little consideration of the interactions between the WWTP and the sewer. This may lead to under-performing solutions as the overall impact of the urban wastewater system (UWWS), i.e. the sewer and WWTP, on the receiving water is not fully appraised (Lau et al., 2002).

Integrated modelling of the sewer system, WWTP and receiving water body is a valuable tool in providing a holistic view of system performance (Meirlaen, 2002; Butler and Schütze, 2005; Vanrolleghem et al., 2005; Bach et al., 2014). It has already been used to demonstrate the potential for significant improvements in river water quality by optimising an integrated operational strategy of an UWWS without the need for upgrade or redesign of the treatment system (Schütze et al., 2002; Fu et al., 2008). Apart from surface water quality analysis, multiple features of system performance (e.g. GHG emissions, cost) can also be evaluated using mathematical modelling (Fu et al., 2008; Sweetapple et al., 2014a) and be considered simultaneously in optimising system operation by multi-objective optimisation tools (Deb et al., 2002).

The aim of this study is to develop a new permitting framework

for the comprehensive regulation of WWTP effluent and CSOs, which reduces overall environmental impacts and improves treatment cost effectiveness simultaneously. An operational strategy-based permitting approach based on integrated control of the whole urban wastewater system, rather than traditional end-of-pipe limits or CSO spill frequency, is introduced in this paper. It is developed based on the latest systems thinking using integrated UWWS modelling, multi-objective optimisation, and visual analytics. The proposed approach is applied to a case study site and in the regulation context of England and Wales, UK.

2. Proposed permitting framework

A four step decision-making framework (Fig. 1) is proposed for the development of operational strategy-based permitting.

Step I: Due to the wide environmental, economic and social impacts of permitting policy (Johnstone and Horan, 1996), a broad coalition of stakeholders (e.g. wastewater dischargers, regulators, farmers, Non-Governmental Organisations (NGOs), academic experts, local residents) should be engaged in the first step to ensure no important perspectives are neglected in the decision-making. Structured and facilitated discussion fora should be arranged (e.g. workshops, customer engagement panels) to give all stakeholders an equal opportunity to express their needs and views and to facilitate discussions and exchange of information. A quantitative analytical procedure based on a correlation test (Yurdakul and Tansel İc, 2009) is then employed to identify key stakeholders' interests without requiring full knowledge on the participants. To achieve this, the different stakeholder interests are first described by performance indicators (with the help of analysts and facilitation specialists) that can be assessed by an integrated UWWS model. For example, a fish farmer's interests can be formulated in terms of the DO and ammonia concentrations in the river downstream of the wastewater discharge. An independent analysis supported by the integrated UWWS model is then conducted to provide a balanced overview of the correlations and trade-offs between the performance indicators by analysing results from various operational scenario simulations. If two or more performance indicators are strongly correlated, only one is needed for further steps of the decision-making process (Hurford et al., 2014). The identified representative indicators are used in Step II as objectives to optimise system operational strategies.

Step II: Evolutionary algorithms (EAs) are a class of stochastic optimisation methods that simulate the process of natural evolution (Nicklow et al., 2010; Reed et al., 2013). They are considered to be especially suited to multi-objective optimisation problems (Reed et al., 2013) and perform better than other blind search strategies (Valenzuela-Rendon and Uresti-Charre, 1997). Multi-objective evolutionary algorithms (MOEAs) are chosen for the optimisation of integrated UWWS operation in this research because a) the UWWS is a non-linear system with various physical, chemical and biological processes, so the search for 'best' operational strategy cannot be solved by analytical methods; b) there are many operational handles in the system and therefore numerous combinations of operational variable settings, which makes it impractical to use enumerative techniques; and c) different (even conflicting) aspects of the system performance can be considered simultaneously in a single optimisation run. Non-dominated Sorting Genetic Algorithm-II (NSGA-II) (Deb et al., 2002), an improved version of NSGA and popular for its computational efficiency and good performance (Coello, 2006), is employed in this study, though others can also be applied.

To start, an optimisation problem is formulated, which consists of:

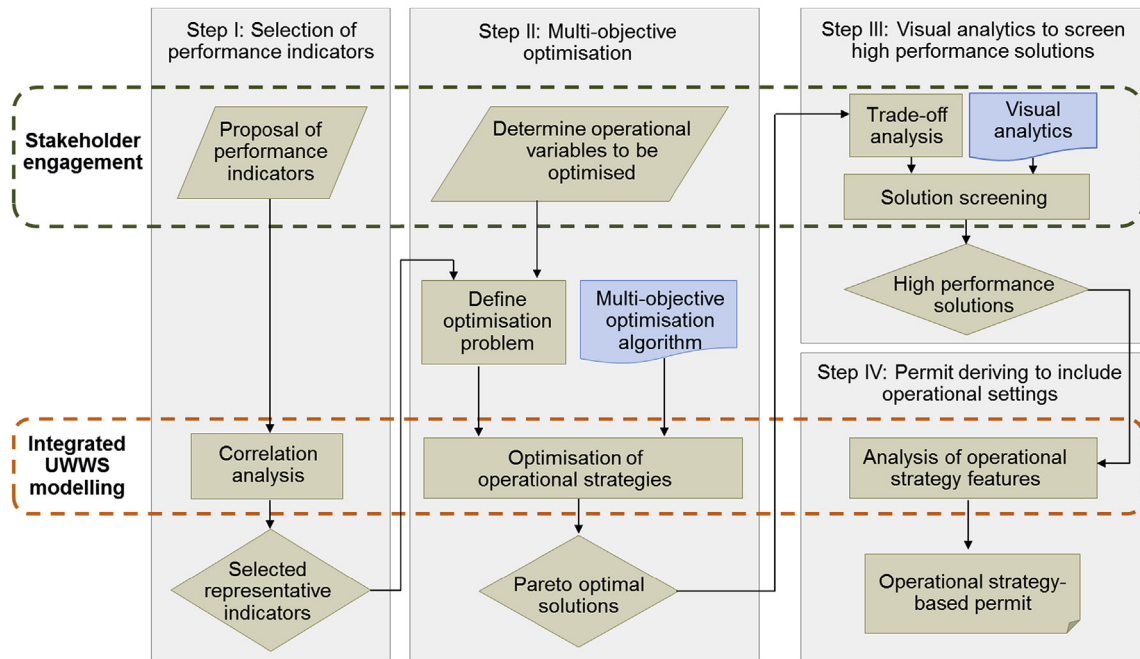

Fig. 1. Decision-making framework for operational strategy-based permitting.

- Optimisation objectives, which are the selected performance indicators from Step I;
- Decision variables (i.e. the settings of the operational handles) and associated value ranges: this information needs support from stakeholders who have detailed knowledge of the UWWS; and
- Constraints, such as design requirements and legal/regulatory obligations to be complied with. As physical/hydraulic laws of water flow in the UWWS are provided by the set of equations that govern the cause-and-effect relationship in the model, they do not need additional specifications for the constraints.

In this case, the optimisation was carried out by coupling the optimisation algorithm and an integrated modelling platform (see below). NSGA-II first randomly generates a population of operational strategies within defined ranges (i.e. the first generation), each of which is evaluated by long-term dynamic simulation on the integrated modelling platform. Results of the system performance after the evaluation are fed back to the algorithm and compared with other operational strategy solutions in the generation. Those of good performance are selected to 'breed' the next generation, and after a designated number of generations, a Pareto front of optimal solutions is produced. They are non-dominated solutions which cannot be further improved in terms of one objective without worsening another. Although the Pareto optimal solutions are not the best ones in an absolute mathematical sense, they are the best approximate solutions achieved within limited resources (Hurford et al., 2014).

Step III: As a result of multi-objective optimisation, a large number of optimal solutions are produced that perform differently against various objectives. Visual analytics can analyse large data sets in an informative and visually appealing way to facilitate decision-making (Fu et al., 2013; Hurford et al., 2014). Thus it is applied in this study to provide a holistic view of the trade-offs between the objectives, i.e. the benefits achievable in one performance aspect and the level of sacrifice required in other aspects. Based on the trade-off relationships and practical concerns (e.g.

financial constraints, water quality planning targets), desirable solutions are selected from the pool of optimal results. An interactive cyclic screening process, assisted by the visual analytics tools, is set up to incorporate the decision-makers' preference in the selection of high performance solutions. Stakeholders are also engaged in this step to input local knowledge so that practically achievable decisions are made.

Step IV: Details of the selected solutions are assessed to explore common operational features to achieve the desired performance. Based on this, a set of operational variable values are determined as the permit. In this case, an uncertainty analysis is conducted using Latin Hypercube Sampling (LHS) (McKay et al., 1979; Iman et al., 1980) to assess the sensitivity of system performance to operational setting changes. The confidence ranges of operational settings which produce reliable performance are also included in the permit to allow for flexibility.

3. Case study

3.1. System description

The proposed framework is illustrated by applying it to a well-characterised integrated UWWS (Schütze et al., 2002; Fu et al., 2008; Astaraie-Imani et al., 2012). It consists of a sewer system adapted from a literature standard (ATV, 1992), an activated sludge WWTP based on and calibrated against the Norwich works in the UK (Lessard and Beck, 1993; Schütze et al., 2002) and a hypothetical river (Schütze et al., 2002). It serves a population of about 150,000 producing an average dry weather flow (DWF) of 27,500 m³/d. The layout of the integrated UWWS is shown in Fig. 2.

The sewer system consists of a network of seven sub-catchments, with a total impervious area of 725.8 ha (7.258 km²). Four online pass-through storage tanks are set up at the downstream end of the linked sub-catchments. In addition, an off-line pass-through storm tank (an off-line tank remains dry during dry weather periods while an online tank always has sewage flowing through it) is located at the inlet of the treatment train, resulting in

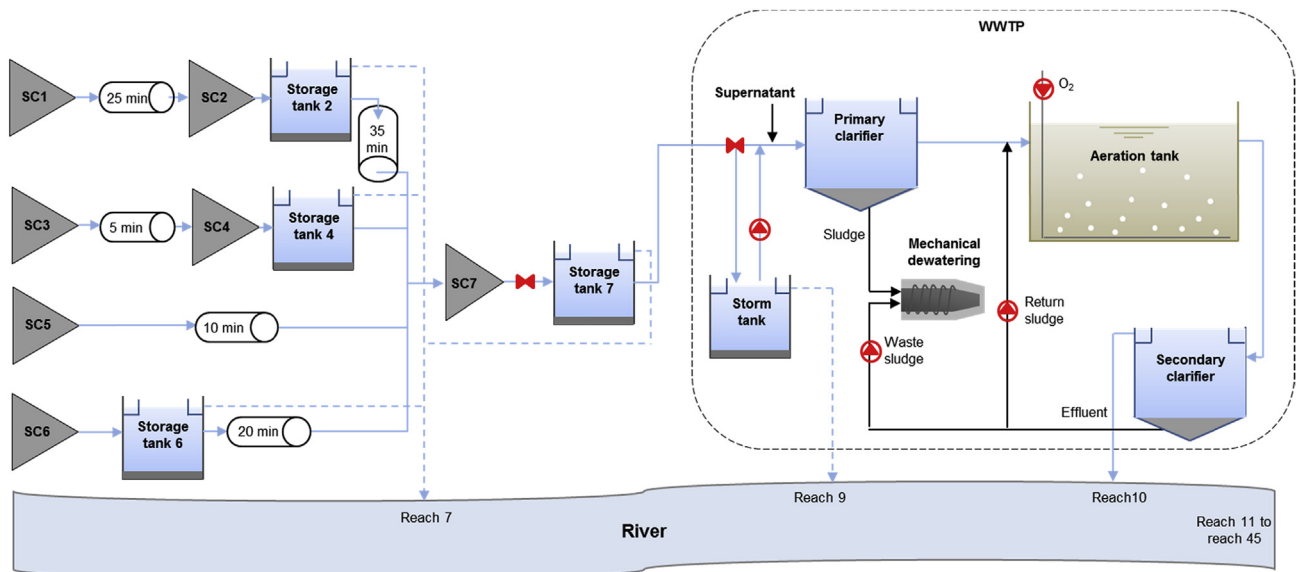

Fig. 2. Schematic representation of the catchment (SC: sub-catchment).

a total storage volume of the system of 19,950 m³. Filling of the storm tank starts as soon as the maximum inflow rate to the primary clarifier is reached, and emptying is triggered when the inflow drops below a threshold value. Other process units in the WWTP are a primary clarifier, an aeration tank, a secondary clarifier and a mechanical dewatering unit with no wastewater bypass. In the Norwich treatment plant, a consolidation tank is used before further treatment of waste sludge and the overflow from the tank is pumped back to the primary clarifier (Schütze et al., 2002). However, no data are available on the consolidation tank or the processes of handling the concentrated sludge except the flow and water quality of the supernatant (i.e. overflow from the consolidation tank) (Lessard and Beck, 1993). As such, an ideal mechanical dewatering model is used in this study to estimate the sludge treatment costs, while an inflow based on the reported data of the supernatant is added to the primary clarifier model for a more accurate representation of the impact of the recycle line to the wastewater treatment. The receiving river has a base flow of 4.5 m³/s that provides a dry weather dilution ratio of approximately 1:15. The river is 45 km in length and is equally divided into 45 reaches for simulation. Details are provided as [Supplementary Information](#) on the dimensions of the catchment, the treatment process units and the river.

3.2. Modelling of the case study

This case study was first built by Schütze et al. (2002) for the research on modelling and control of integrated UWWSS and has since been employed in a number of studies (Lau et al., 2002; Zacharof et al., 2004; Astaraie-Imani et al., 2012; Casal-Campos et al., 2015). Due to the different simulation platforms used and diverse modelling techniques provided even by the same simulation software, models applied on this same case study site can be different. In this work, the software platform SIMBA6 developed by IFAK (IFAK, 2009) is used for integrated UWWSS modelling. The KOSIM (Schütze et al., 2002) and Nash cascade approach (Butler and Davies, 2011) are used to simulate runoff and washoff in the watersheds and sewers. An extended version of Activated Sludge Model No. 1 (Henze et al., 2000), namely ASM1tm (IFAK, 2009) which added the modelling of hydrolysis in anaerobic conditions,

N-incorporation of nitrate and variable temperature etc., is used for the simulation of nitrification process in the WWTP. Hydrodynamic transport and transformation in rivers are simulated by the Storm Water Management Model (SWMM5) (U.S. Environmental Protection Agency, 2010b), and river water quality process is simulated using the model developed by Lijklema et al. (1996) which applies and extends the classic Streeter-Phelps model (Streeter and Phelps, 1925). Converter models connect the sub-modules so that all components can be run in a synchronous way.

For simplicity, ammonia is the single pollutant investigated in this work (though BOD and DO are also modelled), as both the 90% ile and 99%ile total ammonia concentration in the downstream river, being 0.38 NH₃-N mg/L and 0.84 NH₃-N mg/L respectively, fail the environmental standard limits (i.e. 0.3 NH₃-N mg/L and 0.7 NH₃-N mg/L) (Defra, 2010) with baseline operational settings according to a one-year simulation using the first input data set. Another data set with only different rainfall and river flow is used in Section 5 for uncertainty analysis. Most of the input variables have dynamic values based on environmental monitoring data or predefined patterns, except the flow rate (20 L/s) and water quality of the supernatant, river water temperature (17 °C), and water quality of rainfall runoff. Further details are provided in the Supporting Information, including model simplifications, assumptions and limitations.

3.3. Operational scheme of the case study

There are seven key operational settings in the UWWSS, which are:

- 1) Overflow threshold of storage tank 7 (i.e. the last and largest tank before the WWTP), referred hereafter as "PFF";
- 2) Overflow threshold of the storm tank located in the front of the WWTP, in short as "FFT";
- 3) Emptying threshold of the storm tank (Ept_{thr});
- 4) Emptying rate of the storm tank (Ept);
- 5) Return sludge pumping rate (RS);
- 6) Waste sludge pumping rate (WS); and
- 7) Aeration rate (O_2).

The values of the settings in the baseline scenario are shown in the second column of Table 1, along with the ranges (Schütze et al., 2002) within which the settings are optimised to find operational solutions to meet the river target on ammonia whilst maximising other aspects of system performance. Other settings in the system (e.g. the overflow threshold limits of tanks 2, 4 and 6) are not optimised as they were found to have limited impact on the system performance using a one-at-a-time (OAT) sensitivity analysis.

4. Results

Results of the case study are presented in this section to demonstrate the permitting process. It is not the intention to prescribe a specific operational strategy or permit.

4.1. Selection of performance indicators

Besides the discharger and the regulators, stakeholders are usually those directly or indirectly affected bodies by the wastewater treatment and discharges located near the UWWS in the catchment. Due to the semi-hypothetical nature of the studied case, no actual discussion fora were organised. Yet to illustrate the proposed method, the following performance indicators were identified by interviews with the water industry and literature review in representing potential stakeholders' interests.

- Energy cost incurred in pumping, aeration and sludge treatment: it is selected to measure economic implications of operational changes which is of direct relevance to the discharger's interest; it is also an indicator of GHG emissions, especially the amount of emissions under regulation (i.e. energy-oriented GHG emissions) (Parliament of the UK, 2010; Sweetapple et al., 2014a), thus is of common interest to all stakeholders due to the wide impacts of global warming;
- Water quality of the WWTP effluent: including pollutant concentration levels measured by different statistical parameters (e.g. 95%ile value, which is a widely used parameter in end-of-pipe permits, implying there is no compliance failure if the permit limit is met for more than 95% of the samples collected), and process stability expressed as the standard deviation of effluent water quality during one-year simulation (Niku and Schroeder, 1981); effluent water quality is one of the main interests of the discharger;
- Downstream river water quality: this is of great interest to parties (e.g. NGOs, farmers, local residents) who are directly or indirectly affected by the river water quality after the wastewater discharges; it can be described by pollutant concentration levels based on statistical parameters (e.g. 90%ile, 99%ile) as required by UK standards (Defra, 2010), and river quality stability expressed by standard deviation; and
- Environmental risk: A risk indicator is introduced (Equation (1)) according to the widely used definition as the product of probability and consequences (Liu et al., 2011). By definition, it

complements other risk-related environmental water quality parameters (e.g. 99%ile river quality limit (FWR, 2012), Fundamental Intermittent Standards (FWR, 2012)) by measuring the probability and consequence of water quality deterioration beyond threshold limits.

$$\text{Risk} = \sum (P_{C_j} \times \max(0, C_j - C_{\text{limit}})) \quad (1)$$

where C_j (mg/L) is the concentration of investigated pollutant in the river at time step j , which is regarded as a discrete random variable, taking values at $j = 1, \dots, N$ (N is the total number of time steps in the simulation); C_{limit} (mg/L) is the river water quality standard limit; and P_{C_j} is the probability of river water quality value being C_j . P_{C_j} is determined by dividing the duration of river water quality being C_j in a run by the total simulation time, which takes the value of n/N (n is the total number of time steps when the river water quality is C_j). The consequence of river water quality being C_j is zero if it is below C_{limit} and is $C_j - C_{\text{limit}}$ otherwise. As illustrated in Fig. 3, this equation calculates the shaded area of the time series graph of river quality to indicate the risk of exceedance of the safety level for environmental protection.

1000 operational scenarios were generated by LHS to assess the correlation relationship between the proposed indicators, and operational cost, effluent quality standard deviation and environmental risk were selected as representative indicators (definition of the three indicators and the linear correlation coefficients (R) between all proposed indicators are provided as Supplementary Information).

4.2. Multi-objective optimisation and trade-off analysis

4.2.1. Formulation of multi-objective optimisation problem

The settings of the seven operational variables are optimised within the reasonable ranges (i.e. the last two columns of Table 1) to minimise the three objectives selected in Section 4.1. The optimisation problem is described in Equations (2)–(4), subject to legislative constraints on river water quality, i.e. 0.3 NH₃-N mg/L (90%ile) and 0.7 NH₃-N mg/L (99%ile).

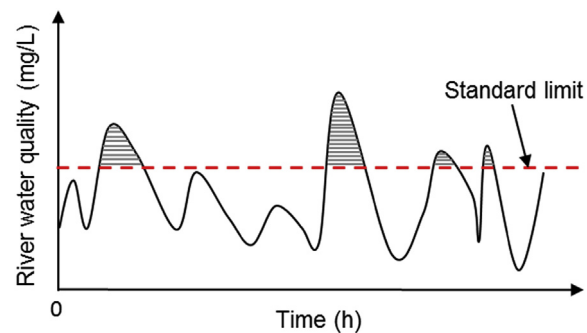

Fig. 3. Illustration of risk calculated in a time series of river water quality.

Table 1
Baseline values and ranges of the operational variables.

Operational variable	Baseline value (m ³ /d)	Lower bound value (m ³ /d)	Higher bound value (m ³ /d)
CSO (tank 7) overflow threshold (PF _F)	137,500 (i.e. 5DWF)	82,500 (i.e. 3DWF)	220,000 (i.e. 8DWF)
Storm tank overflow threshold (FF _T)	82,500 (i.e. 3DWF)	55,000 (i.e. 2DWF)	137,500 (i.e. 5DWF)
Storm tank emptying threshold (E _{pt-thr})	24,000	16,800	31,200
Storm tank emptying rate (E _{pt})	12,000	7200	24,000
Return sludge pumping rate (RS)	14,400	7200	24,000
Waste sludge pumping rate (WS)	660	240	960
Aeration rate (O ₂)	720,000	240,000	1,200,000

$$\text{Min} (C_{\text{pump}} + C_{\text{aeration}} + C_{\text{sludge}}) \quad (2)$$

$$\text{Min} (STD_{\text{AMM}}) \quad (3)$$

$$\text{Min} (\text{Risk}) \quad (4)$$

where C_{pump} (£) is the cost for pumping, C_{aeration} (£) is the cost for aeration, C_{sludge} (£) is the energy cost for sludge dewatering, STD_{AMM} (NH₃-N mg/L) is the standard deviation of WWTP effluent total ammonia concentration, Risk (NH₃-N mg/L) is the environmental risk as defined in Equation (1). The cost of aeration and pumping is calculated as the product of electricity consumption (directly available as model output) and an assumed electricity tariff rate, while the expenditure for sludge dewatering is estimated according to the mechanical dewatering cost per gram of dry waste sludge (Mamais et al., 2009) and the total weight of dry sludge generated in the simulated year. The cost of sludge disposal is not accounted for as no relevant information is available for this case study and indeed the cost can vary greatly depending on the final purpose (e.g. landfill, incineration, reuse for building materials, land application) (Yang et al., 2015) and destination (i.e. transportation distance) (Zang et al., 2015) of the disposed sludge.

Given the computational inefficiency of running long-term simulation in SIMBA6, a practical approach is adopted to balance between population size and generation number of NSGA-II. A widely accepted setting of population size 100 is used in this study (Deb et al., 2002), and a usage of generation number of 15 is found to produce satisfactory Pareto fronts, and thus is used in this study and repeated for ten random seed runs. Default settings of distribution index for crossover (20) and mutation (20) are used.

4.2.2. Trade-off analysis based on optimisation results

The optimisation results are projected against the three objectives shown in Fig. 4a, and separately in three pairs in Fig. 4b–d. Solving the three-objective optimisation problem automatically solves three two-objective sub-problems at the same time (i.e. non-dominated solutions of two-objective optimisation can be deduced directly from the three-objective optimal solutions, without the need for running three two-objective optimisations), and the results are shown in different symbols (i.e. magenta triangles, blue dots and black crosses) in Fig. 4b–d.

Each solution on the curve corresponds to an operational strategy (i.e. seven operational variable values) and its associated performance. Compared to the baseline scenario results (cost: 0.82 Million £/year, effluent standard deviation: 2.01 NH₃-N mg/L, environmental risk: 0.03 NH₃-N mg/L, not shown in Fig. 4 for clarity), significant improvement is achieved in all three objectives by optimisation. This agrees with the findings from previous research (Butler and Schütze, 2005; Fu et al., 2008) and demonstrates the advantage of operational optimisation, in particular from an integrated system perspective.

However, trade-offs exist between the three objectives, disclosing the conflicts between different stakeholders' interests and the need to consider all the three objectives so that no key aspect is neglected. For example, the best solutions for the wastewater dischargers (i.e. low cost and low effluent standard deviation marked in magenta triangles) are of high environmental risk as the most cost-effective way of achieving high effluent stability is by limiting inflows to the WWTP thus leading to more overflows. Stakeholders affected by the wastewater discharges (e.g. fish farmers) would prefer solutions with low environmental risk and low effluent standard deviation (positively correlated with the 90% ile river total ammonia concentration), yet the corresponding

Pareto optimal solutions (marked in black crosses) are distributed evenly across a somewhat broad value range, indicating that a compromise needs to be sought.

4.3. Solution screening using visual analytics

The screening process is primarily based on visual analytics to explore the complex trade-offs by successively adding more objectives into the trade-offs to aid the decision-maker in better capturing objective interactions and discovering high-performing solutions, which may not be fully captured in a lower-dimensional space (Fu et al., 2013). Other indicators proposed in the first step can also be used if additional information is provided. Colour designation facilitates the screening process by presenting results in an informative way and recording the decision-makers' preferences during the process. Below is an example of how screening is conducted.

- The process started from the trade-off graph between effluent standard deviation and environmental risk as shown in Fig. 5a. Two cut-off lines were drawn to screen out solutions at both ends coloured in cyan. The top left group of solutions has relatively high environmental risk, while the solutions at bottom right have high standard deviation (i.e. low stability) in effluent discharge without much improvement in risk reduction.
- In Fig. 5b, solutions were projected against risk and a third objective of operational cost, and the screening information in Fig. 5a was retained by keeping the colour of the solutions. Cost-effective solutions achieving low environmental risk with reasonably low cost were selected from the chosen solutions from Fig. 5a and were highlighted in green (they were in dark blue in Fig. 5a). Thus the colour of solutions in the current figure is the combination of screening results of the current and previous steps.
- A fourth objective total pollutant discharge load was used in Fig. 5c to select solutions with low discharge load from the UWS and the high performing solutions retained were highlighted in magenta.
- A fifth objective, e.g. river standard deviation (Fig. 5d), river 90% ile quality and river 99%ile quality, was also tested for screening but no additional information was provided, i.e. no solutions were screened out from the high performance solution set. Thus solutions highlighted in magenta are the final selected solutions, which will be used to derive operational strategy-based permits.

The indicators used for screening and the definition of threshold lines are typically determined by regulators negotiated with other stakeholders. Besides the interactive nature, the screening can also be a cyclic process as preferences may change affected by results in the next screening step.

4.4. Permit derivation based on high performing solutions

Fig. 6 shows operational variable values and corresponding performance of the Pareto optimal solutions (solid lines, with high performing solutions selected from Section 4.3 highlighted in magenta) and the baseline case (black dashed line). Values are normalised by the feasible ranges (for operational variables) and the minimum and maximum values (for performance indicators) and are shown in Fig. 6. The return sludge pumping rate and waste sludge rate have been highly modified through optimisation, indicating sub-optimal settings during sludge-related operation is a main reason for the poor performance of the baseline case. Despite the highly optimised sludge pumping rates, the optimal solutions display remarkable diversity in other operational settings (reflected

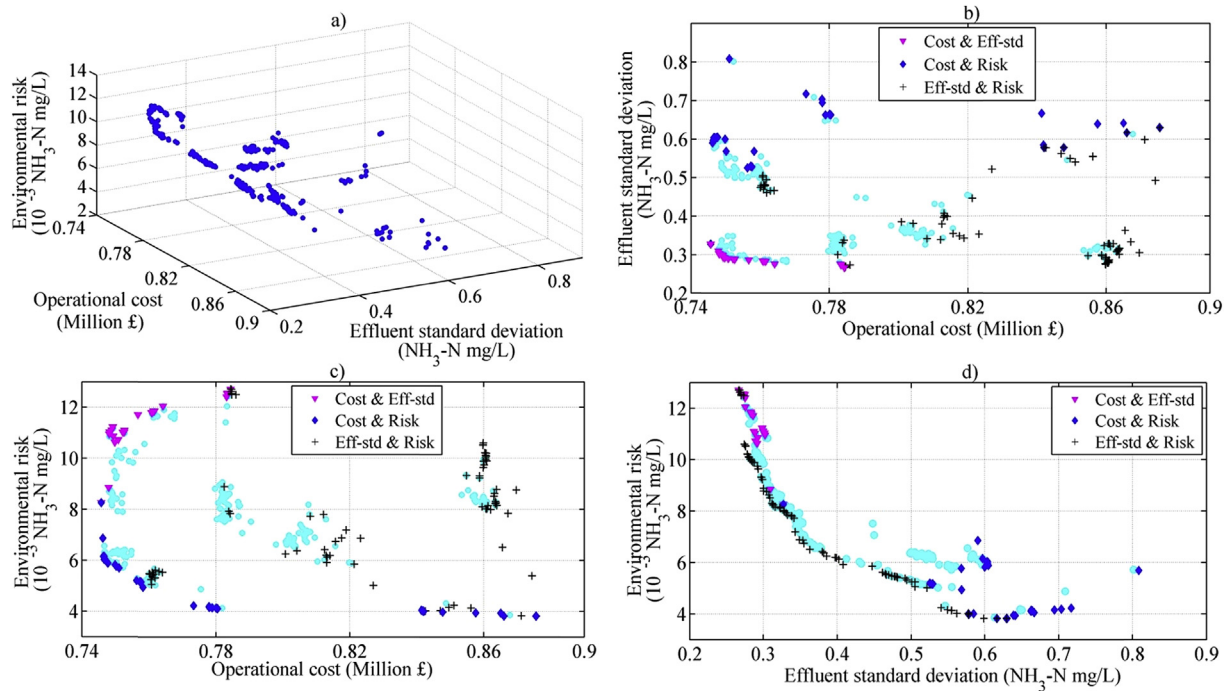

Fig. 4. Non-dominated Pareto solutions using objectives of operational cost, effluent standard deviation and environmental risk in two- and three-dimensional space (Non-dominated solutions using two objectives are highlighted in different colours than cyan. Cost - operational cost, Eff-std - effluent standard deviation, and Risk - environmental risk). (For interpretation of the references to colour in this figure legend, the reader is referred to the web version of this article.)

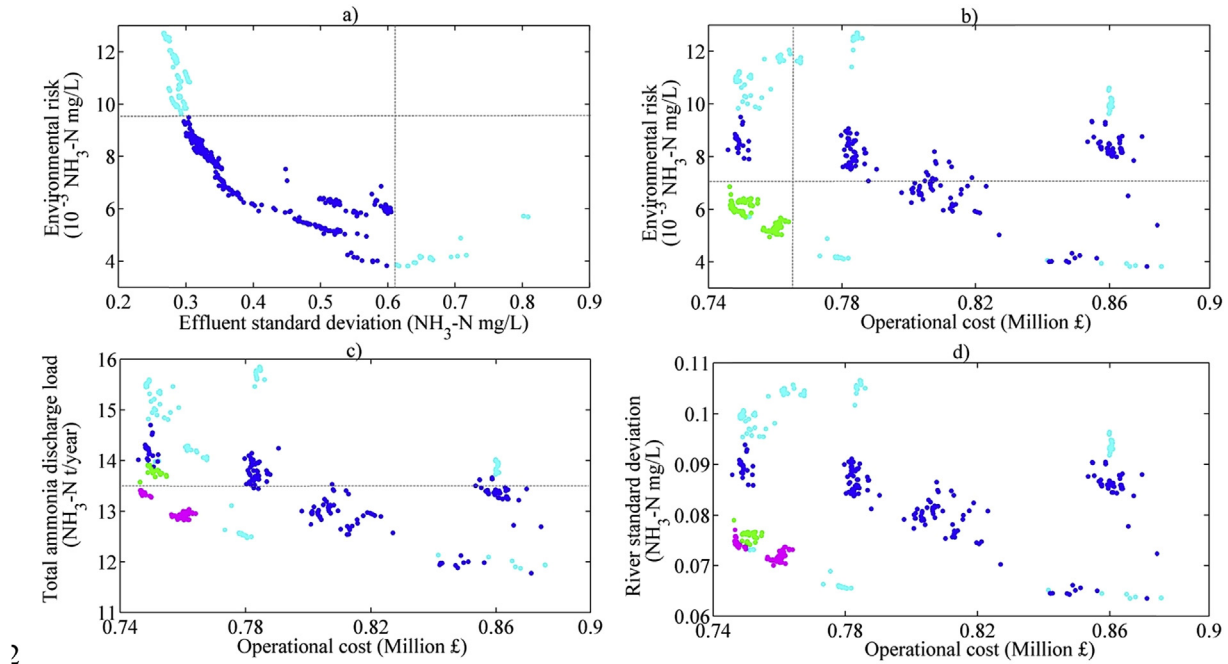

Fig. 5. Screening of the Pareto optimal solutions through visual analytics (high performing solutions selected in a) to c) are highlighted in blue, green and magenta, respectively). (For interpretation of the references to colour in this figure legend, the reader is referred to the web version of this article.)

in the range of setting values), so does the system performance. However, the high performing solutions selected through screening are very similar in both operation and performance and are apparently divided into two groups (in cases where groupings need to be more clearly identified, techniques such as cluster analysis (Mandel et al., 2015) can be employed for the group segmentation).

Group ‘A’ solutions have lower cost than group ‘B’ but at the expense of lower effluent stability and higher environmental risk. Though the values of *PFF* and *FFT* of the group ‘A’ solutions are much larger than the other group (i.e. more inflow are allowed into the WWTP), their volumes of overflow do not differ greatly due to lower *Ept-thr* values (i.e. less flow in the storm tank is pumped back

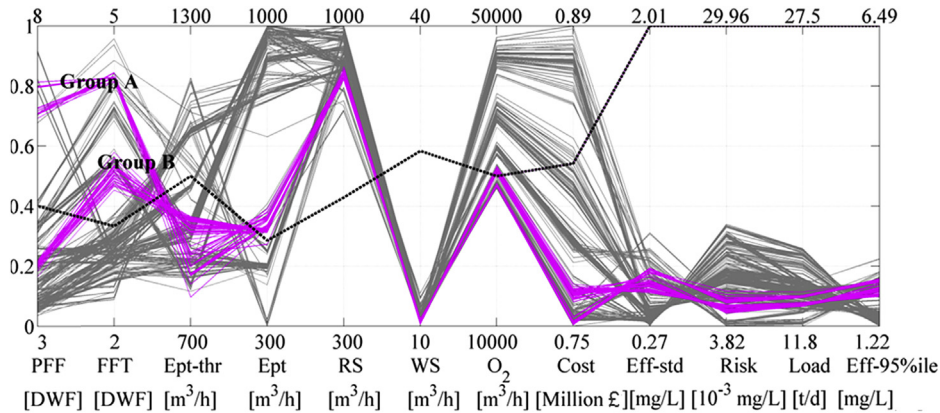

Fig. 6. Values of operational variable settings, performance indicators and effluent 95%ile concentration of the Pareto optimal solutions (in grey), selected high performing solutions (in magenta) by the screening process and the baseline operational strategy (in black) (operational variables: PFF - pass forward flow, FFT - flow to full treatment, Ept-thr - storm tank emptying threshold, Ept - storm tank emptying rate, RS - return sludge rate, WS - waste sludge rate and O2 - aeration rate, and performance indicators: Cost - operational cost, Eff-std - effluent standard deviation, Risk - environmental risk and Load - total pollutant discharge load). (For interpretation of the references to colour in this figure legend, the reader is referred to the web version of this article.)

to the treatment process). A single solution from the high performing solution set can be chosen for permitting, but to allow for flexibility in practice, the feasibility of using value ranges based on one group is investigated.

Group 'A' is used here to explain the permit derivation process. Based on the 34 solutions in the group, the minimum and maximum values of the seven operational variables and the five performance indicators are used as boundaries of 12 value ranges. LHS is performed to generate 20,000 operational scenarios within the seven operational value ranges, and the generated operational strategies are evaluated in SIMBA6 to estimate the confidence level of reliable performance if the system operates following the prescribed ranges. Results show that 89% of the 20,000 samples have effluent 95%ile values within the expected range, and the number is 71% if the other four performance indicators are also considered. Considering the high confidence level, the seven operational value ranges based on the 34 selected solutions can be used for permitting. However, if the confidence level is low, the operational ranges can be narrowed and the LHS re-run until an acceptable level of certainty is achieved.

Table 2 shows the proposed permit for the investigated case based on the operational strategy-based permitting solutions (i.e. group 'A' solutions). It includes a set of operational variable values (taken as average values for illustration purposes) and corresponding ranges set for flexibility. Based on detailed monitoring of the flow after each operational handle in the permit and effluent water quality, the compliance of the permit can be assessed by examining whether the operational equipment runs properly. An allowance can be made, such as a 5% deviation rate, if it does not result in severe consequences as reflected in the effluent water quality records. Though effluent water quality is not the key criteria for the assessment, it should be examined as well for it offers

valuable information for post-construction evaluation of the effectiveness of the permitting decision. Monitoring data of good quality provides insights on how to improve the permitting process if needed.

5. Discussion

5.1. Performance of operational strategy-based permitting in comparison with traditional approach

To compare with the traditional end-of-pipe permitting approach, a 95%ile permit is derived for this case using the stochastic permitting model River Quality Planning (RQP) (Murdoch, 2012) which is widely used in the UK (see details of the permit deriving process in Supplementary Information). In the baseline scenario, the river water quality at reach 9 after receiving all intermittent wastewater discharges (90%ile: 0.09 NH₃-N mg/L, 99%ile: 0.63 NH₃-N mg/L) complies with the environmental standards, thus no change in the design or operation of the storage and storm tanks needs to be made under the current regulation in England and Wales. Based on the upstream river condition (after CSO spills) and WWTP effluent discharge characteristics under the baseline scenario, the derived permit is 1.42 NH₃-N mg/L, which is stricter than the 95%ile values of the operational strategy-based permitting solutions as shown in Table 2. An experiment is designed, as described below, to investigate whether the tighter 95%ile limit leads to more environmentally protective and/or cost-effective results.

A 10,000-shot LHS was performed to search for compliant operational strategy solutions to achieve the 95%ile permit. To be consistent with the current permitting method, only operational settings in the WWTP were varied in the LHS, while keeping the Pass Forward Flow (PFF) and Flow to Full Treatment (FFT) settings as the baseline values (i.e. 5DWF and 3DWF). Even so, various combinations of operational settings in the WWTP were found to produce 95%ile values lower than the required level. As shown in Table 3, although effluent standard deviation of the compliant solutions (i.e. the fourth column of Table 3) is lower than the operational strategy-based permitting solutions, environmental risk (measured by indicators 'environmental risk' and 'total discharge load') is much higher due to increased overflow caused by lower PFF and FFT settings. Moreover, operational cost of the compliant solutions can be 19% more.

Table 2
Proposed form of operational strategy-based permit.

Operational variables	Permit value	Permit range
PFF (DWF)	6.7	[6.4, 7.1]
FFT (DWF)	4.4	[4.4, 4.5]
Ept-thr (m ³ /h)	820	[784, 860]
Ept (m ³ /h)	530	[491, 573]
RS (m ³ /h)	880	[875, 893]
WS (m ³ /h)	10.7	[10.6, 10.8]
O2 (m ³ /h)	28,800	[28,573, 29,039]

Table 3
Comparison of performance between the proposed operational strategy-based permitting approach and the traditional end-of-pipe method.

Performance indicator	Operational strategy-based permitting solutions	20,000 LHS samples	End-of-pipe permit compliant solutions
Effluent 95%ile concentration (NH ₃ -N mg/L)	[1.99, 2.06]	[1.96, 2.10]	[1.23, 1.42]
Total operational cost (Million £/year)	[0.75, 0.76]	[0.75, 0.76]	[0.75, 0.90]
Effluent standard deviation (NH ₃ -N mg/L)	[0.58, 0.61]	[0.56, 0.63]	[0.27, 0.35]
Environmental risk (10 ⁻³ NH ₃ -N mg/L)	[5.83, 6.56]	[5.75, 6.59]	[8.34, 11.96]
Total discharge load (NH ₃ -N t/year)	[13.3, 13.4]	[13.2, 13.5]	[12.9, 14.5]

The performance of the LHS samples used for confidence assessment in Section 4.4 is also shown in Table 3. Only slight deviation in performance from operational strategy-based permitting solutions is observed from the 20,000 operational strategies generated within the prescribed ranges (Table 2). By contrast, the end-of-pipe permit solutions behave in a diverse manner. Hence, despite the effectiveness in restricting WWTP effluent discharge quality, the end-of-pipe permitting approach is insufficient in controlling other aspects of system behaviour compared to regulation on operation. Faced by the complex environmental challenges and the pursuit of cost-effectiveness, a more stringent regulation by traditional permitting approach may produce undesirable outcomes.

5.2. Reliability of the operational strategy-based permitting approach

By permitting operational strategies based on modelled system performance, the success of the newly developed approach relies on a) accuracy of an integrated UWWS model in representing the real world system, and b) good performance of the optimised operational strategies under future environmental conditions. As all models are imperfect abstractions of reality, uncertainty in modelling should (if possible) be considered in model-based decision-making (Mcintyre, 2004; Refsgaard et al., 2007; Ragas et al., 2009; Carter and White, 2012). For the employed integrated UWWS model, uncertainty in the model output can result from:

- imperfect knowledge in input data, e.g. the simplified diurnal patterns defined to describe the dynamic wastewater inflow and quality to the WWTP;
- model structure (i.e. incomplete or simplified description of the modelled process as compared to reality) and model parameter (not all parameters in the model are validated with real-life data);
- computer implementation of the model (e.g. numerical approximations, resolution in space and time); and
- inherent stochastic or chaotic nature of natural phenomena (e.g. rainfall), which is not predictable and is non-reducible by more studies.

A comprehensive uncertainty analysis has not been conducted in this study because even if the model can simulate the system accurately, the permitted operational strategies, optimised using a pre-defined input data set, may not be the best solutions for future conditions. This is especially so under the pressure of climate change and the widespread degradation of environmental water quality conditions. Hence, in this case, another input data set (referred to as 'B') from another area was used to examine the performance of the permitted operational strategies at a different locational setting. Rainfall of the second data set is 26% greater than that of the first data set (referred to as 'A') measured by annual rainfall depth, and the upstream river condition is much poorer, thus can be deemed as a 'worse' scenario (details of data set 'B' described in Supplementary Information). Optimisation was run to

find the optimal operational solutions with data set 'B'. Fig. 7 shows the optimisation results as compared to the performance of the permitted operational solution (i.e. the strategy corresponding to the second column of Table 2) fed by the new input data set highlighted in red square. Results show that the permit solution is not dominated by (i.e. no worse than) the optimal solutions and is outstanding in the performance of cost and environmental risk, however, its effluent standard deviation is higher than all optimal solutions. This is caused by the heavier rainfall which adversely affects the wastewater treatment efficiency. In comparison, the optimal solutions obtained under the new rainfall data have lower PFF and FFT settings thus protect the WWTP from overloading. Nevertheless, the permitted operational strategy provides reasonably good and reliable performance.

To further ensure the robustness of the derived operational strategy, more historical data sets should be applied if available or by using hypothetical data generated by stochastic experiments.

5.3. A win-win solution

By simulating behaviour of the regulated facilities, the integrated UWWS modelling enables regulators to gain a better understanding of the economic and environmental impacts of the traditional end-of-pipe permitting approach. So, to respond to a more stringent 95%ile effluent permit, three compliance strategies are possible: a) increase treatment capacity (e.g. elevate the aeration rate, build a new reactor); b) discharge wastewater through other outlets which are weakly regulated and monitored; and c) implement an innovative technological solution. The first option often pushes up the cost (or GHG emissions) (Earnhart, 2007), contradicting the interests of the regulated community as well as the aim of sustainable development. Neither is the second option desirable, as implied by the high environmental risk of the operational strategies with low PFF and FFT settings that cause increased overflows as presented in Section 5.1. The third option is favourable both to the regulators and the regulated parties (Alm, 1992). As demonstrated by this study and previous research (Butler and Schütze, 2005; Vanrolleghem et al., 2005; Fu et al., 2008), optimisation of operation based on integrated modelling is an innovative technological solution among others such as resource recovery and pollution prevention technologies. It can achieve environmental quality objectives in a reliable and energy efficient way. In particular, it exploits the potential of the existing system without the need for capital investment in enlarging treatment capacity.

Besides technological innovation, good regulation is also essential for effective risk management. Although more stringent 95%ile permit can be achieved by a range of operational strategies, the solutions can be of higher environmental risk and/or cause higher GHG emissions than other options that produce lower effluent quality. End-of-pipe quality has been used as a surrogate indicator of UWWS performance (Chapman, 1991), but is only valid if all discharges in the system are well monitored and controlled, and environmental impacts of wastewater discharges are fully appraised. Given the common situation of ineffective control on intermittent spills (e.g. CSOs, storm tank overflows) (Blanksby,

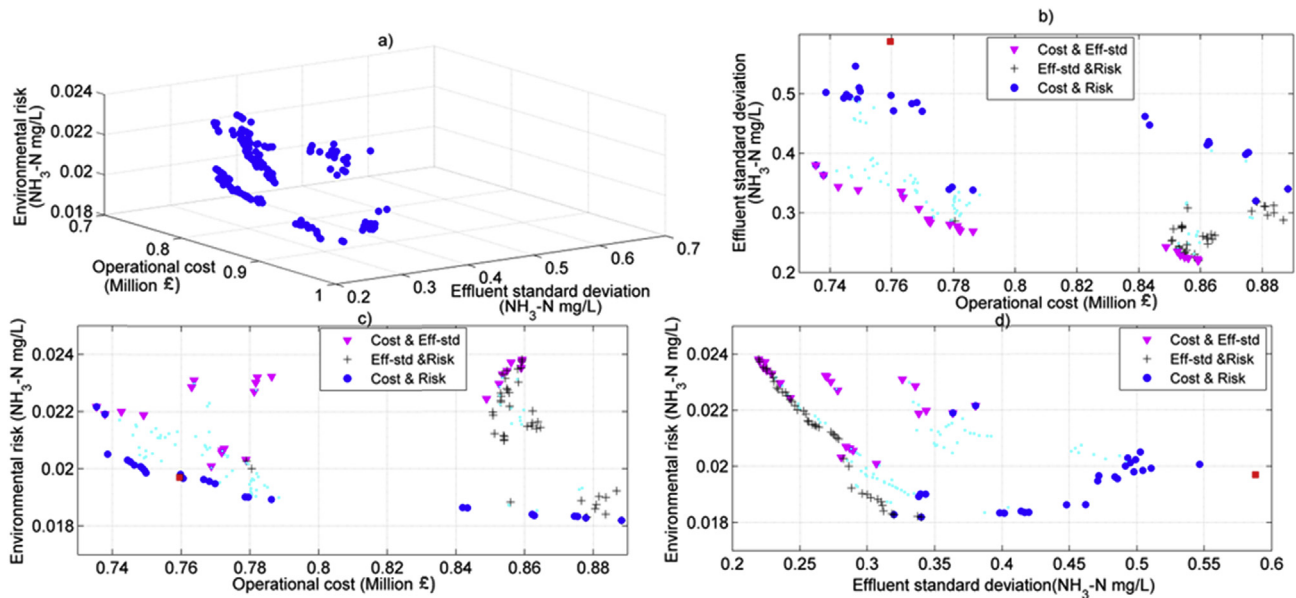

Fig. 7. Performance of the permitted operational solution in Table 2 under input data set 'B' (shown in red square) against non-dominated Pareto solutions optimised using data set 'B' with objectives of operational cost, effluent standard deviation and environmental risk in two- and three-dimensional space (Non-dominated solutions using two objectives are highlighted in different colours than cyan. Cost - operational cost, Eff-std - effluent standard deviation, and Risk - environmental risk). (For interpretation of the references to colour in this figure legend, the reader is referred to the web version of this article.)

2002) and fragmented regulation of water pollution and GHG emissions, limited success could be achieved (at least cost-effectively) by over-tightening end-of-pipe limits of WWTP effluent discharges. However, if the end-of-pipe regulation is removed, more environmentally protective operational solutions are achievable. The proposed innovative regulation approach is an attempt to move away from restrictive and conservative 'outcome-based' permitting to more flexible and responsive 'performance-based' permitting, based on a fuller understanding of the system as a whole.

The proposed four-step permitting framework is a useful tool in developing the innovative permits with stakeholder input at all points in the permitting process. It not only ensures informed and balanced decision-making, but also fits into wider environmental management strategies, such as the US Watershed Management Program (Pelley, 1997) and European River Basin Management Plan (European Parliament and Council of the European Union, 2000; Kallis and Butler, 2001). NSGA-II, visualisation tool and LHS are employed to facilitate the complex optimisation and decision-making process. Results show that by operational strategy-based permitting solutions the operational cost, treatment process variability and environmental risk can be simultaneously reduced, resulting in 'win-win' situations, contrary to the traditional paradigm. Though the study was conducted by using the single pollutant total ammonia, the proposed permitting framework can be readily implemented on other pollutants. The complexity would increase if multiple pollutants are considered as it would not be a simple sum of permitting on single pollutants but needs to consider the intricate relationships between the pollutants. However, the framework should still be applicable as: a) the Genetic Algorithms are capable of solving many-objective (i.e. four objectives or more) problems, b) the visual analytics tools could handle a large number of solutions or objectives, and c) correlation analysis can be employed to identify the synergy effects among the pollutants thus reduce the number of objectives.

5.4. Roadmap to operational strategy-based permitting

Some current regulation practices provide good examples of how operational strategy-based permitting can be applied. Operational strategies of sewer systems are already allowed by the UK permitting policy for the regulation of intermittent wastewater overflows. Sewer models can be employed to derive the operational strategies to meet emission-based standards on overflow spill frequency or environmental quality standard of the receiving water. The computational tools are described in the regulation guidance as 'invaluable design tools' that can be used to 'gain an understanding of the way in which the system works' (Environment Agency, 2011). As such, integrated UWWs modelling could gain acceptance by the regulators, although simplified model versions would increase the viability of practical application. Nevertheless, there are still some hurdles that inhibit the application as described below.

a) Knowledge gap between academia, industry and regulators:

It is the interest of wastewater service providers (WWSPs) to operate the wastewater systems in a reliable and cost-effective manner. However, there is a lack of acknowledgment of the potential of operational improvement. Besides, the industry has rarely applied comprehensive models in the operational phase, despite a few successful exceptions (Pleau et al., 2005; Langeveld et al., 2013). So dialogue between academia and industry is needed to convey the technical knowledge and boost industry's interest and proactiveness.

Although potential benefits have been demonstrated in this paper, operational strategy-based permitting should be a complement rather than substitute for the traditional approach. The new approach can be resource intensive for practical implementation due to the comprehensive permitting models and methods and monitoring devices required to be set up and efforts needed from both the WWSPs and regulators (further discussed below). Hence, the proposed permitting approach is only cost-effective if the benefits achievable by an optimal operational strategy outweigh

the cost of implementing the new method of permitting in practice. Nevertheless, it is important for the regulators to understand the potential benefits of flexible permitting options and accept the application (at least trial) in practice.

b) Investment for the new permitting approach:

As mentioned earlier, investment is still needed for the new approach. Similar to the sewer modelling for control on CSOs, the water sector will need to take the responsibility to develop integrated models of the regulated system. A well policed monitoring system will still be needed to ensure compliance, but it is likely to be more automated and potentially in real-time. Thus investment is also needed for the installation of monitoring equipment.

Although most of the expense may fall to the WWSPs, efforts are also needed from the regulators to enforce and implement the new form of permitting, e.g. auditing of the integrated model, and setting up the measurement scheme (similar to the UK MCERTS scheme (Environment Agency, 2011)) for compliance analysis, etc.

c) Uncertain cost and benefits:

A field trial is the next logical step to test the idea and provide more confident information on cost and benefits. This would, in turn, require the engagement and buy-in of the water sector.

6. Conclusions

The main findings from this study are summarised as follows.

- A new permitting format based on operational settings is introduced and found to be a promising strategy to adapt to the increasingly demanding regulatory and economic climate, because:
 - a) Environmental water quality can be improved by minimising the total impact of all wastewater discharges from an UWWS to the environment.
 - b) Energy-oriented GHG emissions, as inferred by the cost entailed in the operation of the treatment works, may be achieved together with improvement of environmental water quality by better system operation though trade-off exists. Further studies that explicitly model and evaluate the emission of (direct and indirect) GHG emissions would enable deeper understanding on the relationship between the two environmental outcomes.
 - c) The regulation of intermittent wastewater overflows is bolstered through enhanced operation of the sewer network by coordinating with that of the WWTP, so that the overall impact to the environment and cost is reduced.
- The four-step decision analysis framework, which brings together a set of simulation models, optimisation techniques and visual analytics, is an effective and efficient tool in identifying high performing, win-win solutions to multiple stakeholders' interests.
- The operational strategy-based permitting approach is found to be reliable because a) there are insignificant deviations in system performance when the operational variable values vary within specified ranges, and b) the permitted strategy performs well when tested on a different input data set with more intense rainfall and poorer upstream river water quality.
- The next step for the research is to extend the approach to further water quality variables, more comprehensive analysis of environmental impacts of wastewater treatment (e.g. detailed modelling of GHG emissions, soil pollution from waste sludge), other innovative technological solutions (e.g. resource recovery

technology), more detailed and realistic integrated UWWS models (in particular sewers and rivers), further urban catchments, other surface water types (e.g. lakes) and to undertake detailed field trials supported by engaged stakeholders.

Acknowledgment

The authors would like to thank the financial support from the SANITAS project (EU FP7 Marie Curie Initial Training Network – ITN – 289193) and the support of North Wyke Farm, Environment Agency and Atkins. We also thank the three anonymous reviewers whose comments/suggestions helped improve and clarify this manuscript.

Appendix A. Supplementary information

Supplementary information related to this article can be found at <http://dx.doi.org/10.1016/j.watres.2016.05.078>.

References

- Alm, A.L., 1992. Environmental and technological innovation. *Environ. Sci. Technol.* 26, 1300.
- Astarai-Imani, M., Kapelan, Z., Fu, G., Butler, D., 2012. Assessing the combined effects of urbanisation and climate change on the river water quality in an integrated urban wastewater system in the UK. *J. Environ. Manag.* 112, 1–9.
- ATV, 1992. Standards for the Dimensioning and Design of Stormwater Structures in Combined Sewers. Druck Carl Weyler KG., Bonn. German Standards.
- Bach, P.M., Rauch, W., Mikkelsen, P.S., McCarthy, D.T., Deletic, A., 2014. A critical review of integrated urban water modelling - urban drainage and beyond. *Environ. Model. Softw.* 54, 88–107. <http://dx.doi.org/10.1016/j.envsoft.2013.12.018>.
- Blanksby, J., 2002. A review of the UK approach to measuring the performance of combined sewer overflows. *Urban Water J.* 4, 191–198.
- Butler, D., Davies, J., 2011. *Urban Drainage*, third ed. Spon Press, London, UK.
- Butler, D., Schütze, M., 2005. Integrating simulation models with a view to optimal control of urban wastewater systems. *Environ. Model. Softw.* 20, 415–426.
- Carter, J.G., White, I., 2012. Environmental planning and management in an age of uncertainty: the case of the water framework directive. *J. Environ. Manag.* 113, 228–236.
- Casal-Campos, A., Fu, G., Butler, D., Moore, A., 2015. An integrated environmental assessment of green and gray infrastructure strategies for robust decision making. *Environ. Sci. Technol.* 49, 8307–8314.
- Castro-Barros, C.M., Daelman, M.R.J., Mampaey, K.E., van Loosdrecht, M.C.M., Volcke, E.I.P., 2015. Effect of aeration regime on N₂O emission from partial nitrification-anammox in a full-scale granular sludge reactor. *Water Res.* 68, 793–803.
- Chapman, P.M., 1991. Environmental quality criteria: what type should we be developing? *Environ. Sci. Technol.* 25, 1353–1359.
- Clifforde, I.T., Crabtree, R.W., Andrews, H.O., 2006. 10 years experience of CSO management in the United Kingdom. In: *Proceedings of the Water Environment Federation® Technical Exhibition and Conference*. 21–25 October, 2006, Dallas, USA, pp. 3744–3756.
- Coello, C.A.C., 2006. Evolutionary multi-objective optimization: a historical view of the field. *IEEE Comput. Intell. Mag.* 28–36.
- Deb, K., Member, A., Pratap, A., Agarwal, S., Meyarivan, T., 2002. A fast and elitist multiobjective genetic algorithm: NSGA-II. *IEEE T. Evol. Comput.* 6, 182–197.
- Defra, 2010. The River Basin Districts Typology, Standards and Groundwater Threshold Values (Water Framework Directive) (England and Wales) Directions 2010. England and Wales. Standard 2010 No.38. [viewed 11 April 2016] Retrieved from: <http://gov.wales/docs/legislation/inforcononsi/environmental/100804direct38.pdf>.
- Earnhart, D., 2007. Effects of permitted effluent limits on environmental compliance levels. *Ecol. Econ.* 61, 178–193. <http://dx.doi.org/10.1016/j.ecolecon.2006.07.031>.
- Environment Agency, 2011. How to Comply with Your Environmental Permit. Additional Guidance for: Water Discharge and Groundwater (from Point Source) Activity Permits (EPR 7.01). England and Wales. Regulation Guide. [viewed 11 April 2016] Retrieved from: https://www.gov.uk/government/uploads/system/uploads/attachment_data/file/298081/LIT_7356_4132bc.pdf.
- European Parliament and Council of the European Union, 2000. Directive 2000/60/EC establishing a framework for community action in the field of water policy. Off. J. Eur. Commun. No L 327 [viewed 11 April 2016] Available from: http://ec.europa.eu/health/endocrine_disruptors/docs/wfd_200060ec_directive_en.pdf.
- Flores-Alsina, X., Corominas, L., Snip, L., Vanrolleghem, P.A., 2011. Including greenhouse gas emissions during benchmarking of wastewater treatment plant control strategies. *Water Res.* 45, 4700–4710. <http://dx.doi.org/10.1016/j.watres.2011.04.040>.
- Fu, G., Butler, D., Khu, S.-T., 2008. Multiple objective optimal control of integrated

- urban wastewater systems. *Environ. Model. Softw.* 23, 225–234.
- Fu, G., Kapelan, Z., Kasprzyk, J.R., Reed, P., Asce, M., 2013. Optimal design of water distribution systems using many-objective visual analytics. *J. Water Res. Pl.-ASCE* 139, 624–633. [http://dx.doi.org/10.1061/\(ASCE\)WR.1943-5452.0000311](http://dx.doi.org/10.1061/(ASCE)WR.1943-5452.0000311).
- FWR, 2012. Urban Pollution Management Manual, third ed. Foundation for Water Research, Marlow, UK. ISBN: 095217121x. [viewed 11 April 2016] Available at: <http://www.fwr.org/UPM3/>.
- Georges, K., Thornton, A., Sadler, R., 2009. Transforming Wastewater Treatment to Reduce Carbon Emissions. Technical Report No SC070010/R2. Environment Agency, Bristol [viewed 11 April 2016] Retrieved from. https://www.gov.uk/government/uploads/system/uploads/attachment_data/file/291633/scho1209brnz-e-e.pdf.
- Guest, J.S., Skerlos, S.J., Barnard, J.L., Beck, M.B., Daigger, G.T., Hilger, H., Jackson, S.J., Karvazy, K., Kelly, L., Macpherson, L., Mihelcic, J.R., Pramanik, A., Raskin, L., van Loosdrecht, M.C.M., Yeh, D., Love, N.G., 2009. A new planning and design paradigm to achieve sustainable resource recovery from wastewater. *Environ. Sci. Technol.* 43, 6126–6130. <http://dx.doi.org/10.1021/es803001r>.
- Henze, M., Gujer, W., Mino, T., van Loosdrecht, M.C.M., 2000. *Activated Sludge Models ASM1, ASM2, ASM2d and ASM3*. IWA Publishing, London, UK.
- Hurford, A.P., Huskova, I., Harou, J.J., 2014. Using many-objective trade-off analysis to help dams promote economic development, protect the poor and enhance ecological health. *Environ. Sci. Policy* 38, 72–86. <http://dx.doi.org/10.1016/j.envsci.2013.10.003>.
- IFAK, 2009. SIMBA 6.0: Simulation of Wastewater Systems. User's Guide. ifak System Company, Magdeburg, Germany.
- Iman, R.L., Davenport, J.M., Zeigler, D.K., 1980. *Latin Hypercube Sampling (Program User's Guide)*. Sandia National Laboratories, Albuquerque, USA.
- Jin, Z., Gong, H., Wang, K., 2015. Application of hybrid coagulation microfiltration with air backflushing to direct sewage concentration for organic matter recovery. *J. Hazard. Mater.* 283, 824–831.
- Johnstone, D.W.M., Horan, N.J., 1996. Institutional developments, standards and river quality: a UK history and some lessons for industrialising countries. *Water Sci. Technol.* 33, 211–222.
- Kallis, G., Butler, D., 2001. The EU water framework directive: measures and implications. *Water Policy* 3, 125–142.
- Kay, D., Kershaw, S., Lee, R., Wyer, M.D., Watkins, J., Francis, C., 2008. Results of field investigations into the impact of intermittent sewage discharges on the microbiological quality of wild mussels (*Mytilus Edulis*) in a tidal estuary. *Water Res.* 42, 3033–3046. <http://dx.doi.org/10.1016/j.watres.2008.03.020>.
- Langeveld, J.G., Benedetti, L., de Klein, J.J.M., Nopens, I., Amerlinck, Y., van Nieuwenhuijzen, A., Flameling, T., van Zanten, O., Weijers, S., 2013. Impact-based integrated real-time control for improvement of the Dommel river water quality. *Urban Water J.* 10, 312–329. <http://dx.doi.org/10.1080/1573062X.2013.820332>.
- Lau, J., Butler, D., Schütze, M., 2002. Is combined sewer overflow spill frequency/volume a good indicator of receiving water quality impact? *Urban Water J.* 4, 181–189.
- Lessard, P., Beck, B., 1993. Dynamic modelling of the activated sludge process: a case study. *Water Res.* 27, 963–978.
- Lijklema, L., Aalderink, R.H., Ruiter, H. de, 1996. Procesbeschrijvingen DUFLOW Zuurstoffhuishouding in Stromende En Stagnante Water-Systemen. In: Aalderink, R.H., Blom, G., Lijklema, L., Icke, J., Ruiter, D.H. (Eds.), *DUFLOW-Water Quality Process Descriptions (in Dutch)*. STOWA, Model Description Document. [viewed 11 April 2016] Retrieved from. http://www.stowa.nl/Upload/publicaties2/mld_4924_cid_3914_73895750_1998-18_DUFLOW_waterkwaliteit-procesbeschrijvingen.pdf.
- Liu, W., Moran, C.J., Vink, S., 2011. Quantitative risk-based approach for improving water quality management in mining. *Environ. Sci. Technol.* 45, 7459–7464.
- Mamais, D., Tzimas, A., Efthimiadou, A., Kissandrakis, J., Andreidakis, A., 2009. Evaluation of different sludge mechanical dewatering technologies. *J. Residuals Sci. Tech.* 6, 27–34.
- Mandel, P., Maurel, M., Chenu, D., 2015. Better understanding of water quality evolution in water distribution networks using data clustering. *Water Res.* 87, 69–78. <http://dx.doi.org/10.1016/j.watres.2015.08.061>.
- Mccarty, P.L., Bae, J., Kim, J., 2011. Domestic wastewater treatment as a net energy producer-can this be achieved? *Environ. Sci. Technol.* 45, 7100–7106.
- Mcintyre, N., 2004. *Analysis of Uncertainty in River Water Quality Modelling (PhD thesis)*. Imperial College London, UK.
- McKay, M.D., Beckman, R.J., Conover, W.J., 1979. A comparison of three methods for selecting values of input variables in the analysis of output from a computer code. *Technometrics* 21, 239–245.
- Meirlaen, J., 2002. Immission based real-time control of the integrated urban wastewater system (PhD thesis). Ghent University, Belgium.
- Murdoch, N., 2012. *Introduction to River Quality Planning Setting Permits and Assessing Compliance. User's Guide*. Environment Agency, England.
- Nardell, G., 2012. *Combined Sewage Overflows: the UK in Deep Water at Luxembourg [WWW Document]*. Lexology. URL: <http://www.lexology.com/library/detail.aspx?g=3e23dd9c-1f4b-447e-97c4-1846101a2dd1>.
- Nicklow, J., Asce, F., Reed, P., Asce, M., Savic, D., Dessalegne, T., Asce, M., Harrell, L., Asce, M., Chan-hilton, A., Asce, M., Karamouz, M., Asce, F., Minsker, B., Asce, M., Ostfeld, A., Asce, M., Singh, A., Asce, M., Zechman, E., Asce, M., 2010. *State of the art for genetic algorithms and beyond in water resources planning and management*. *J. Water Resour. Plan. Manag.* 136, 412–432.
- Niku, S., Schroeder, E.D., 1981. Stability of activated sludge processes based on statistical measures. *J. Water Pollut. Control Fed.* 53, 457–470.
- Parliament of the UK, 2010. *The CRC Energy Efficiency Scheme Order 2010* [viewed 11 April 2016] Available at: <http://www.legislation.gov.uk/ukdsi/2010/9780111491232/contents>.
- Pelley, J., 1997. Watershed management approach gains with states. *Environ. Sci. Technol.* 31, 322–323.
- Phillips, P.J., Chalmers, A.T., Gray, J.L., Kolpin, D.W., Foreman, W.T., Wall, G.R., 2012. Combined sewer overflows: an environmental source of hormones and wastewater micropollutants. *Environ. Sci. Technol.* 46, 5336–5343.
- Pleau, M., Colas, H., Lavallee, P., Pelletier, G., Bonin, R., 2005. Global optimal real-time control of the Quebec urban drainage system. *Environ. Model. Softw.* 20, 401–413. <http://dx.doi.org/10.1016/j.envsoft.2004.02.009>.
- Ragas, A.M., Huijbregts, M.A., Henning-de Jong, I., Leuven, R.S., 2009. Uncertainty in environmental risk assessment: implications for risk-based management of river basins. *Integr. Environ. Assess. Manag.* 5, 27–37.
- Reed, P.M., Hadka, D., Herman, J.D., Kasprzyk, J.R., Kollat, J.B., 2013. Evolutionary multiobjective optimization in water resources: the past, present, and future. *Adv. Water Resour.* 51, 438–456. <http://dx.doi.org/10.1016/j.advwatres.2012.01.005>.
- Refsgaard, J.C., van der Sluijs, J.P., Højberg, A.L., Vanrolleghem, P.A., 2007. Uncertainty in the environmental modelling process - a framework and guidance. *Environ. Model. Softw.* 22, 1543–1556. <http://dx.doi.org/10.1016/j.envsoft.2007.02.004>.
- Schütze, M., Butler, D., Beck, B., 2002. *Modelling, Simulation and Control of Urban Wastewater Systems*. Springer, London, UK.
- Selman, M., Greenhalgh, S., Branosky, E., Jones, C., Guiling, J., 2009. *Water Quality Trading Programs: an International Overview*. WRI Issue Br. March 2009, pp. 1–16.
- Seven Trent Water Limited, 2013. *Changing Course through the Sustainable Implementation of the Water Framework Directive. Fourth Report in the Changing Course series*. [viewed 11 April 2016] Retrieved from. <https://s3-eu-west-1.amazonaws.com/media.aws.stwater.co.uk/upload/pdf/ChangingCourse-WaterFrameworkDirectiveNov2013.pdf>.
- Streeter, H.W., Phelps, B., 1925. *A Study of the Pollution and Natural Purification of the Ohio River III: Factors Concerned in the Phenomena of Oxidation and Reaeration*. Public Health Bulletin, Washington, DC, USA. <http://dx.doi.org/10.1002/ange.19290420217>.
- Strous, M., Van Gerven, E., Zheng, P., Kuenen, J.G., Jetten, M.S.M., 1997. Ammonium removal from concentrated waste streams with the anaerobic ammonium oxidation (anammox) process in different reactor configurations. *Water Res.* 31, 1955–1962. [http://dx.doi.org/10.1016/S0043-1354\(97\)00055-9](http://dx.doi.org/10.1016/S0043-1354(97)00055-9).
- Sweetapple, C., Fu, G., Butler, D., 2014a. Multi-objective optimisation of wastewater treatment plant control to reduce greenhouse gas emissions. *Water Res.* 55, 52–62. <http://dx.doi.org/10.1016/j.watres.2014.02.018>.
- Sweetapple, C., Fu, G., Butler, D., 2014b. Identifying sensitive sources and key control handles for the reduction of greenhouse gas emissions from wastewater treatment. *Water Res.* 62, 249–259. <http://dx.doi.org/10.1016/j.watres.2014.06.002>.
- Thornton, A., Sunner, N., Haack, M., 2010. Real time control for reduced aeration and chemical consumption: a full scale study. *Water Sci. Technol.* 61, 2169–2175. <http://dx.doi.org/10.2166/wst.2010.971>.
- U.S. Environmental Protection Agency, 2013. *Emerging Technologies for Wastewater Treatment and In-plant Wet Weather Management. Technical Report for U.S. Environmental Protection Agency by Tetra Tech, Inc. and Fairfax, Virginia*. [viewed 11 April 2016] Available at: <http://nepis.epa.gov/Exe/ZyNET.exe/P100ILDCTXT?ZyActionD=ZyDocument&Client=EPA&Index=2011+Thru+2015&Docs=&Query=&Time=2011+Thru+2015&Docs=&Query=&Time>.
- U.S. Environmental Protection Agency, 2010a. *NPDES Permit Writers' Manual*. Office of Wastewater Management, Washington, DC, USA.
- U.S. Environmental Protection Agency, 2010b. *Storm Water Management Model. User's Manual Version 5*.
- U.S. Environmental Protection Agency, 2007. *Watershed-based National Pollutant Discharge Elimination System (NPDES) Permitting Technical Guidance*. Office of Wastewater Management, Washington, DC, USA.
- U.S. Environmental Protection Agency, 1999. *Combined Sewer Overflows Guidance for Monitoring and Modeling*. Office of Federal Agency, Washington, DC, USA [viewed 11 April 2016] Available at: <http://nepis.epa.gov/Exe/ZyNET.exe/20004344.TXT?ZyActionD=ZyDocument&Client=EPA&Index=1995+Thru+1999&Docs=&Query=&Time=&EndTime=&SearchMethod=1&TocRestrict=n&Toc=&TocEntry=>.
- U.S. Environmental Protection Agency, 1995. *EPA Combined Sewer Overflows Guidance for Long-term Control Plan*. Office of Water, Washington, DC, USA [viewed 11 April 2016] Retrieved from. <http://www3.epa.gov/npdes/pubs/owm0272.pdf>.
- Valenzuela-Rendon, M., Uresti-Charre, E., 1997. A non-generational genetic algorithm for multiobjective optimization. In: *Proceedings of the Seventh International Conference on Genetic Algorithms*. East Lansing, MI, USA, pp. 658–665.
- Vanrolleghem, P., Benedetti, L., Meirlaen, J., 2005. Modelling and real-time control of the integrated urban wastewater system. *Environ. Model. Softw.* 20, 427–442. <http://dx.doi.org/10.1016/j.envsoft.2004.02.004>.
- Weyrauch, P., Matzinger, A., Pawlowsky-Reusing, E., Plume, S., von Seggern, D., Heinzmann, B., Schroeder, K., Rouault, P., 2010. Contribution of combined sewer overflows to trace contaminant loads in urban streams. *Water Res.* 44, 4451–4462. <http://dx.doi.org/10.1016/j.watres.2010.06.011>.
- Yang, G., Zhang, G., Wang, H., 2015. Current state of sludge production, management, treatment and disposal in China. *Water Res.* 78, 60–73. <http://dx.doi.org/>

- [10.1016/j.watres.2015.04.002](https://doi.org/10.1016/j.watres.2015.04.002).
- Yurdakul, M., Tansel Iç, Y., 2009. Application of correlation test to criteria selection for multi criteria decision making (MCDM) models. *Int. J. Adv. Manuf. Technol.* 40, 403–412. <http://dx.doi.org/10.1007/s00170-007-1324-1>.
- Zacharof, A.I., Butler, D., Schütze, M., Beck, M.B., 2004. Screening for real-time control potential of urban wastewater systems. *J. Hydrol.* 299, 349–362.
- Zang, Y., Li, Y., Wang, C., Zhang, W., Xiong, W., 2015. Towards more accurate life cycle assessment of biological wastewater treatment plants: a review. *J. Clean. Prod.* 107, 676–692. <http://dx.doi.org/10.1016/j.jclepro.2015.05.060>.