



ARROYO CENTER

- CHILDREN AND FAMILIES
- EDUCATION AND THE ARTS
- ENERGY AND ENVIRONMENT
- HEALTH AND HEALTH CARE
- INFRASTRUCTURE AND TRANSPORTATION
- INTERNATIONAL AFFAIRS
- LAW AND BUSINESS
- NATIONAL SECURITY
- POPULATION AND AGING
- PUBLIC SAFETY
- SCIENCE AND TECHNOLOGY
- TERRORISM AND HOMELAND SECURITY

The RAND Corporation is a nonprofit institution that helps improve policy and decisionmaking through research and analysis.

This electronic document was made available from www.rand.org as a public service of the RAND Corporation.

Skip all front matter: [Jump to Page 1](#) ▼

Support RAND

- [Purchase this document](#)
- [Browse Reports & Bookstore](#)
- [Make a charitable contribution](#)

For More Information

- Visit RAND at www.rand.org
- Explore the [RAND Arroyo Center](#)
- View [document details](#)

Limited Electronic Distribution Rights

This document and trademark(s) contained herein are protected by law as indicated in a notice appearing later in this work. This electronic representation of RAND intellectual property is provided for non-commercial use only. Unauthorized posting of RAND electronic documents to a non-RAND website is prohibited. RAND electronic documents are protected under copyright law. Permission is required from RAND to reproduce, or reuse in another form, any of our research documents for commercial use. For information on reprint and linking permissions, please see [RAND Permissions](#).

This report is part of the RAND Corporation research report series. RAND reports present research findings and objective analysis that address the challenges facing the public and private sectors. All RAND reports undergo rigorous peer review to ensure high standards for research quality and objectivity.



Strategy-Policy Mismatch

How the U.S. Army Can Help Close Gaps
in Countering Weapons of Mass Destruction

Timothy M. Bonds, Eric V. Larson, Derek Eaton, Richard E. Darilek



RAND

ARROYO CENTER

Strategy-Policy Mismatch

How the U.S. Army Can Help Close Gaps
in Countering Weapons of Mass Destruction

Timothy M. Bonds, Eric V. Larson, Derek Eaton, Richard E. Darilek

For more information on this publication, visit www.rand.org/t/rr541

Library of Congress Cataloging-in-Publication Data is available for this publication.

ISBN 978-0-8330-8631-0

Published by the RAND Corporation, Santa Monica, Calif.

© Copyright 2014 RAND Corporation

RAND® is a registered trademark.

Limited Print and Electronic Distribution Rights

This document and trademark(s) contained herein are protected by law. This representation of RAND intellectual property is provided for noncommercial use only. Unauthorized posting of this publication online is prohibited. Permission is given to duplicate this document for personal use only, as long as it is unaltered and complete. Permission is required from RAND to reproduce, or reuse in another form, any of its research documents for commercial use. For information on reprint and linking permissions, please visit www.rand.org/pubs/permissions.html.

The RAND Corporation is a research organization that develops solutions to public policy challenges to help make communities throughout the world safer and more secure, healthier and more prosperous. RAND is nonprofit, nonpartisan, and committed to the public interest.

RAND's publications do not necessarily reflect the opinions of its research clients and sponsors.

Support RAND

Make a tax-deductible charitable contribution at
www.rand.org/giving/contribute

www.rand.org

Preface

Two successive presidents have determined that weapons of mass destruction (WMD)—particularly nuclear weapons in the hands of violent extremists—pose the greatest of threats to the American people. Accordingly, the Department of Defense (DoD) has named countering WMD as a primary mission of the U.S. military.

However, DoD does not consider the counter-WMD mission important enough to drive military capacity and capability in this regard—i.e., force size and structure. It permits a potentially critical gap to exist between the importance of countering WMD, as expressed in national strategy, and the actual policy for resources, which dictates force size and structure, as prioritized in the Defense Strategic Guidance.

The research reported here addresses the following questions: How can this national strategy–resource policy gap be closed? How much ground force capacity, as well as what joint capabilities, will be needed to achieve gap closure, at least to greater degrees than at present? In particular, how can the U.S. Army help—especially, with one critical counter-WMD mission, namely, WMD-elimination (WMD-E)?

To address these questions, this report provides a parametric analysis of several illustrative scenarios—using publicly available sources and methods—to assess the magnitude of any required changes to force size and structure. As for specific examples, two especially salient cases are analyzed: (1) operations to secure loose WMD in the event that the Democratic People’s Republic of Korea (DPRK) collapses, and (2) a counterfactual scenario in which U.S. operations were ordered to eliminate the Syrian chemical weapons program in the wake of a Syrian regime collapse.

The analyses contained within this report were completed in 2013. This report results from the RAND Corporation’s Investment in People and Ideas program. Support for this program is provided, in part, by donors and by the independent research and development provisions of RAND’s contracts for the operation of its U.S. Department of Defense federally funded research and development centers.

Contents

Preface	iii
Figures	vii
Tables	ix
Summary	xi
Acknowledgments	xxi
Abbreviations	xxiii
CHAPTER ONE	
Introduction	1
Gap Between WMD Proliferation Threats and Resourcing Priorities.....	2
Past Counter-WMD and Potential Future WMD-E Operations	3
Illustrative WMD-E Scenarios and Associated Ground Force Requirements.....	4
Concluding Observations and Recommendations for DoD and the Army	5
Appendixes.....	6
CHAPTER TWO	
Gaps Between Countering WMD and Prioritizing Resources	7
National Strategy Documents: WMD Proliferation—The Greatest Threat	7
Countering WMD—Ends, Ways, and Means	10
National Security “Ends”	10
Strategic “Ways”	10
Resource Policy “Means”	12
DoD and Army Investments in Doctrine and Organization	14
Doctrine.....	14
Organization—An Army-Centric Example	15
Summary.....	17
CHAPTER THREE	
Counter-WMD Missions and WMD-E Operations	19
Counter-WMD Operations and Challenges in Iraq.....	19

Counter-WMD in Future Operations	23
Syria	23
North Korea	24
Potential Adversary Actions	25
Notional Counter-WMD Operations in Failed States	31
Implications for Force Capability Requirements	33
Mission Success Metrics	36
Culminating Counter-WMD Operations: The WMD-E Mission	38
WMD-E TF Design	38
Estimating the Duration of the WMD-E Mission	39
Summary	40
CHAPTER FOUR	
Illustrative WMD-E Scenarios and Ground Force Requirements	41
General Case: Overview and Summary of WMD-E Force Requirements	42
Potential Contribution of Coalition Partner Forces	46
WMD-E Assault Aviation Requirements	47
WMD-E Chemical Unit Requirements	48
Case 1. State Loses Control Over Its Nuclear Weapons	50
Illustrative Scenario: The Democratic People’s Republic of Korea (DPRK)	50
Campaign Design	52
Intelligence Requirements	55
Parametric Analyses of WMD-E Force Requirements	57
Sensitivity of Force Requirements to Operational Environments and Support Ratios	62
Observations on the DPRK Case Study	64
Case 2. State Use or Loss of Control Over CWs: Illustrative Scenario: Syria	65
Missions, Objectives, and Campaign Design	70
Parametric WMD Elimination Force Requirements Analysis	70
Observations on the Syrian Case Study	74
Summary	74
CHAPTER FIVE	
Concluding Observations	77
APPENDIXES	
A. Selected National Security Documents and Joint and Service Doctrine	81
B. DPRK and Syrian WMD Sites	101
C. Scenario Context for DPRK Case Study	113
D. Review of Available Estimates on Support Ratio in Iraq	119
 Bibliography	 123

Figures

S.1.	Number of BCTs Required for WMD-E Operations at 5–50 Large WMD Sites.....	xv
S.2.	Nominal Time Needed to Complete WMD-E Operations Through the Exploitation Phase.....	xvii
3.1.	Counter-WMD Missions, Key Tasks, Notional Adverse Actions, and Risk “Windows”.....	26
3.2.	Notional Campaign for Counter-WMD Missions.....	34
3.3.	Notional Combined/Joint Force Command Structure for Counter-WMD Missions.....	35
4.1.	Number of BCTs Required for WMD-E Operations at 5–50 Large WMD Sites.....	43
4.2.	Nominal Time Needed to Complete WMD-E Operations Through the Exploitation Phase.....	44
4.3.	Number of CABs Required for WMD-E Operations at 5 to 50 Large WMD Sites.....	48
4.4.	CBRN Units Required to Conduct WMD-E Operations at 5 to 25 Large WMD Sites.....	49
4.5.	Priority DPRK Nuclear and Missile Sites.....	53
4.6.	WMD-E Land Force Requirements for Minimum Number of Highest-Priority DPRK Sites.....	63
4.7.	Exemplar Syrian Chemical and Airfield Sites, Summer 2013.....	69
4.8.	WMD-E Land Force Requirements for Notional Syrian Site List.....	73
A.1.	Integration of Combating WMD in Joint Operations.....	92
A.2.	WMD-E Concept of Operations.....	93
A.3.	WMD-E Campaign Construct.....	94

Tables

3.1.	High-Priority Threats and Potential Casualties (North Korean Example)	24
3.2.	Counter-WMD Missions, Key Tasks, and Exemplar Force Capability Requirements	36
3.3.	Counter-WMD Missions, Key Tasks, and Success Metrics	37
3.4.	Matching WMD-E TF and WMD Site Size	38
3.5.	WMD-E Timelines for a “Typical” Large WMD Site	39
4.1.	Notional DPRK WMD Target Set	51
4.2.	Notional WMD-E Unit Force Requirements for Minimum Number of Highest-Priority Sites	61
4.3.	Notional Syrian WMD Target Set	68
4.4.	Notional Syria Unit Force Requirements for Four Priority Sites	72
A.1.	Strategy, Doctrine, and Other Counter-WMD Related Guidance	89
B.1.	NTI Nuclear Facilities in North Korea	102
B.2.	Notional Potential DPRK WMD Target Set	103
B.3.	Chemical Facilities in Syria	110
B.4.	Notional Syrian WMD Target Set	111
D.1.	Alternate Estimates of Support: Troop Ratios in OEF/OIF/OND	120

Summary

Two successive presidents have determined that weapons of mass destruction (WMD)—particularly nuclear weapons in the hands of violent extremists—pose the greatest of threats to the American people. Furthermore, the Department of Defense (DoD) has named countering WMD as a primary mission of the U.S. military. Paradoxically, however, DoD has decided that counter-WMD missions will not drive the capacity of U.S. forces. This leads to a potentially critical gap between the high importance of combating WMD, as expressed in national strategy, and the low priority of this mission in the Defense Strategic Guidance (DSG).

The United States has made important progress in diplomatic efforts to reduce WMD threats cooperatively, has continued to invest in defenses against ballistic missile attack, and has begun developing capabilities to help mitigate the consequences of a WMD event. However, relatively little investment has been made in the forces and capabilities needed to eliminate WMD arsenals vulnerable to theft as a result of civil war (e.g., Syria), state failure (e.g., the collapse of Democratic People’s Republic of North Korea, [DPRK]), or other pathways to loss or transfer of WMD (e.g., in Pakistan). This is a critical gap because these may be the most likely ways the violent extremists mentioned in U.S. national strategy documents are able to obtain nuclear, biological, or chemical weapons.

Little analysis exists in the public domain to assess the capacity and capabilities required by military forces to conduct WMD-elimination (WMD-E) operations. This report begins addressing the gap between national security strategy and DoD’s resource policy relating to force size (capacity) and structure (capabilities). It examines the gap in terms of *ends*, *ways*, and *means*, and it provides a parametric analysis of several illustrative scenarios—using publicly available sources and methods—to more clearly show the magnitude of the force structure required for WMD-E. The goal is to better inform public discussion of the U.S. Army’s size and structure—particularly the needed Army capabilities for the WMD-E mission.

This report focuses primarily, though not exclusively, on the WMD-E mission area because eliminating highly threatening WMD is, in a real sense, the ultimate mission; all the other WMD mission areas point toward it. We assess what the U.S. Army

can contribute to this overarching national security strategic priority because the Army would play a leading role in resulting missions.

Gap Between WMD Proliferation Threats and Resourcing Priorities

The overarching strategic goal of U.S. counter-WMD efforts—the national security *end*—is to “ensure that states and non-state actors cannot coerce or attack the United States, its forces, or its allies, partners, friends and interests with WMD.”¹ The United States is pursuing this national security *end* through a series of strategic *ways*. These include three pillars—counterproliferation to combat WMD use; nonproliferation to combat WMD proliferation; and consequence management to respond to WMD use—and eight mission areas: (1) offensive operations; (2) elimination; (3) interdiction; (4) active defense; (5) passive defense; (6) WMD consequence management; (7) security cooperation and partner activities; and (8) threat reduction cooperation. Carrying out these strategic *ways* requires resource policy *means* (resourcing of the necessary capacities and capabilities).

Within this context of *ends*, *ways*, and *means*, there appears to be a serious gap between the urgency of the WMD threat (the *end*) and DoD’s resource priorities (the *means*). Specifically, the DSG does not elevate countering WMD to the status of threats that drive military capacity or military capabilities. DoD’s *Defense Budget Priorities and Choices* does name special operations forces as critical capabilities for the counterproliferation mission. But a much larger and more comprehensive capability will be needed to eliminate WMD that might be exposed to theft or proliferation—for example, if the DPRK were to collapse. Also, neither the 2010 Quadrennial Defense Review nor its 2014 successor list a counterproliferation mission among the scenarios used to determine strategic risk—the campaign-level capabilities needed to deal with large-scale WMD programs.

On the matter of funding, recent DoD budget requests include approximately \$19 billion for combating WMD. However, most of this money is directed toward active defense (a strategic *way*), and primarily for ballistic missile defense programs. The remainder is allotted to other counter-WMD programs (various strategic *ways*) but under tight resource controls that feature fixed, unchanging budget shares. Very little—less than 2 percent—appears to be allocated to eliminating WMD stockpiles (the WMD-E strategic *way*) that are potentially vulnerable to theft or interdiction while in transit.

¹ Chairman, Joint Chiefs of Staff, *National Military Strategy to Combat Weapons of Mass Destruction*, Washington, D.C., February 2006, p. 8. According to U.S. statements, there also remain some discrepancies and omissions in the Syrian declaration. To date, the United States has not elaborated on the scale, scope, or specific nature of these omissions.

In summary, the overarching national security strategy for countering WMD appears to affect force structure and budgetary requirements (i.e., resource policy) minimally, if at all. Other *ways* for countering WMD— including doctrine and organization—fare somewhat better. On balance, however, significant gaps tend to dominate the relationship between national security strategy (*ends*) and resource policy (*means*) when it comes to countering WMD.

Past Counter-WMD and Potential Future WMD-E Operations

During Operation Desert Storm (ODS) and again during Operation Iraqi Freedom (OIF), U.S. and coalition forces found it very difficult to find and destroy ballistic missiles still on their launchers—with no confirmed destructions during ODS and perhaps four in OIF. Destroying weapons not yet on launchers and conducting WMD-related industrial operations may be even harder. Despite a significant effort in ODS, thousands of munitions and millions of liters/thousands of metric tons of chemical weapon (CW) agents and precursors were left untouched by the air campaign.² The record on WMD-E operations during OIF is even worse, when operations were hastily ordered by the Office of the Secretary of Defense and, hence, hastily conceived, significantly under-resourced, and pretty much unable to rapidly seize, secure, and search suspected sites.

Today, states such as the DPRK pose a WMD threat to their neighbors, and even to their own citizens. Relative to conventional munitions, civilians will be at even greater risk with chemical munitions because those taking shelter in underground facilities could be exposed to chemical agents. Worse yet, a single nuclear weapon delivered into a large city by aircraft, ballistic missiles, or covert forces could inflict more casualties by an order of magnitude. If either state were to collapse, its WMD and related facilities would be exposed to theft and sale to other states or violent groups, posing a grave and urgent threat to the United States, its allies, and friends.

U.S. and coalition forces should be prepared to counter adversary actions to defeat the WMD-E mission or to render it ineffective—for example, by moving and hiding WMD and related components, attacking entering forces with WMD, dismantling key production equipment for later sale, and proliferating weapons and components once U.S. and coalition forces depart. The level of threat posed by regime remnants will be a significant factor—potentially ranging from uncertain opposition from low-threat regime survivors to openly hostile adversaries posing a high threat to mission

² The United Nations Monitoring, Verification and Inspection Commission (UNMOVIC) supervised the destruction of 411 metric tons of bulk CW agents, about 300 metric tons of weaponized agents, and 2,850 metric tons of key CW precursor chemicals. Some 1,000 additional metric tons of material were destroyed unilaterally in Iraq or during the coalition air campaign. UNMOVIC, *Compendium of Iraq's Proscribed Weapons Programmes in the Chemical, Biological and Missile Areas*, New York, June 2007, pp. 326–333.

success. Time is another key factor: Each passing day increases the risk that weapons or components will be smuggled out of a collapsed regime and sold.

Eliminating WMD—and the industrial-scale capabilities to build and maintain them—is a relatively new and very challenging mission area. As such, a joint and multinational force should perform the WMD-E mission, with a distinctly subordinate joint task force (JTF) being assigned the WMD-E mission.³ This JTF should include specially trained and equipped ad hoc task forces (TFs) that will have to be multifunctional and combat-capable, since they are responsible for cordoning off and conducting search operations within site facilities and for finding, identifying, and securing or removing WMD, materials, and components. They must also be large and capable enough to provide their own security in the context of a broader joint campaign. Metrics for mission success include such yardsticks as the number of weapons and the percentage of key components, materials, equipment, and information recovered, plus the number of personnel debriefed.

Ground forces are especially well suited to performing the WMD-E mission, and Army forces are particularly capable in this regard: They are quintessentially joint and ultimately expandable, given that sufficient resources are provided to bring this military policy option into better alignment with national security strategy.

Illustrative WMD-E Scenarios and Associated Ground Force Requirements

To better understand the potential ground force requirements for WMD-E operations, we show the sensitivity of WMD-E force requirements to such scenario characteristics as the number of WMD sites to be targeted in an initial assault, the assumed level of threat in the operating environment, and the ratio of supporting forces to mission forces, as well as a first-order analysis of the number of large WMD-E TFs that can be supported by currently planned Army force structure. Two notional scenarios were examined, based on countries known to have extensive WMD programs at the time of our research: the Syrian Arab Republic and the DPRK. These scenario-based analyses show the ground force requirements for WMD-E operations embedded in a notional joint campaign and reinforced the importance of considering WMD-E forces in broader U.S. force and campaign planning.

These analyses point to a convergent finding: *The potential ground force requirements associated with WMD-E are substantial; they could consume most or all of the Army's*

³ This is the main purpose of the Standing Joint Force Headquarters for Elimination, which is in the process of moving to, or has achieved, Initial Operating Capability. This headquarters appears to offer key capabilities, but as yet not the full spectrum of maneuver, logistics, and combat capabilities that commanders must be prepared to employ. See Donna Miles, "New Standing Headquarters Focuses on WMD Elimination," American Forces Press Service, June 19, 2013.

ground maneuver and assault aviation forces. There are two key implications of this finding. First, it is crucial for joint force commanders—not just WMD specialists—to understand WMD-E operations and, when drafting their contingency and operational planning for such locales as the DPRK and Syria, to carefully consider the potentially large force requirements associated with these operations. Second, the potential claim of WMD-E operations on available Army force structure is sufficiently high that DoD resource policy decisions involving Army force structure should consider the conventional ground force requirements of WMD-E operations in DoD force-sizing.

Figure S.1 provides a parametric exploration of the ground force requirements in terms of the estimated number of brigade combat teams (BCTs) required for WMD-E operations against different assumed numbers of WMD sites to be assaulted concurrently in initial operations, as well as different levels of threat in four different operational environments. The figure shows the number of active component (AC) BCTs—33—that are expected to be in the force in fiscal year 2017, and the number that would be operationally available assuming a 1:2 boots-on-the-ground (BOG):Dwell ratio (11—one BCT forward, one preparing for deployment, and one in reset from a previous deployment).

With a 1:2 BOG:Dwell ratio, Army force structure limits could be reached at just eight large WMD sites if operations were being conducted in a Hostile/High Threat environment, unless reserve component forces are mobilized. AC forces can

Figure S.1
Number of BCTs Required for WMD-E Operations at 5–50 Large WMD Sites

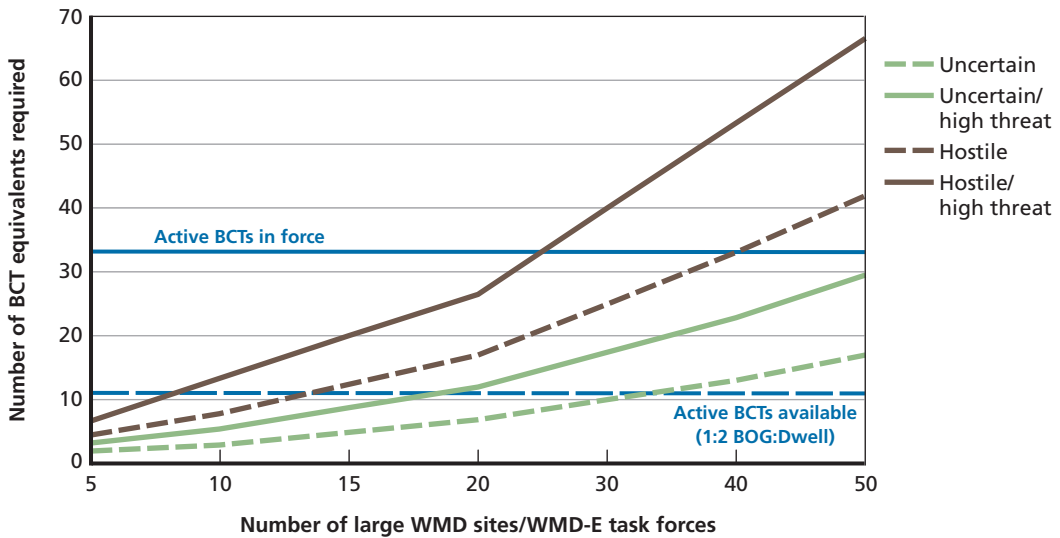

NOTE: The number of BCTs available is based on the assumption of 33 AC three-battalion BCTs in the force in fiscal year 2017.

cover 18 sites in an Uncertain/High Threat environment, or 34 sites in an Uncertain environment.

In looking at the number of sites that may need to be secured in a DPRK collapse scenario, we find that this number could range from the ten most important nuclear sites to far more than 100 nuclear, chemical, biological, and missile sites scattered across the DPRK. And that list may grow over the campaign as new intelligence is gathered or sites are encountered during ongoing operations. We examined this range parametrically, and considered the beneficial effect of coalition partners—including China—that are willing and able to share this burden. We also examined the urgency of quickly securing these sites before weapons or materials could be looted and then hidden for later sale or proliferation.

In a collapsed DPRK scenario, we judge that U.S. entry into the DPRK would be met with hostility by former regime and military members, and perhaps many in the general public. Given the size and capability of the DPRK military, that could pose a threat much worse than U.S. and allied forces faced in Iraq. Our best estimate is that 188,000 U.S. ground troops would be needed for the WMD-E mission—to seize key sites, secure them, search and clear them of WMD, and establish and protect the logistics routes needed to sustain operations. This estimate could decrease to as low as 73,000 if the risk of attack from DPRK military remnants was low, or could increase to 273,000 if the environment worsened to become “high-threat.” The size of the U.S. ground force could also be reduced if conditions allowed contractor personnel to perform some or most of the logistics functions to support these operations.

Similarly, while the current Organization for the Prohibition of Chemical Weapons efforts to eliminate the Syrian CW program appear to have been successful, a collapse in Syria before the regime agreed to inspections and dismantlement of its CW program would most likely have created a hostile environment for U.S. forces.⁴ Therefore, troop numbers in the range of approximately 108,000 would have been needed to simultaneously clear suspected Syrian WMD sites and provide adequate force protection. These forces would have been reduced if the threat level and potential opposition declined, or to the extent that contract logistics services could be used.

Importantly, both the DPRK and Syrian WMD-E estimates exclude any additional forces needed to conduct stability operations, humanitarian assistance, large-scale combat operations against intact state military forces, or the other counter-WMD missions.

In the last months or days of a dying regime, distraught leaders might employ WMD to strike rebellious factions within their nation or real or perceived enemies on their borders. At the same time, some regime elements might seek to sell WMD to other states or extremist groups willing and able to buy them. This places the United

⁴ See Alan Rappoport, “Syria’s Chemical Arsenal Fully Destroyed, U.S. Says,” *New York Times*, August 18, 2014.

States and its allies on the horns of a dilemma: Enter too early and risk precipitating a military strike from a dying regime, perhaps using WMD, or enter too late and risk the proliferation of WMD to dangerous states or extremist groups.

Using the DPRK case to illustrate, Figure S.2 provides a parametric exploration of the total campaign time that might be required to secure and exploit—or to seize and secure sites for later exploitation—a varying number of WMD sites using between ten and 40 WMD-E TFs built around infantry battalions. The JTF commander may need to secure and exploit more sites than initially planned—for instance, to secure newly discovered caches, follow leads on stolen or missing materials, or to conduct a more comprehensive campaign. As the number of sites expands, the length of the campaign will expand accordingly. And, of course, if the average time for addressing a WMD site turned out to be longer, or some individual sites were contaminated or otherwise presented challenges with exploiting, the campaign duration would increase accordingly. Also, the time needed to move forces to theater, maneuver these forces to the sites, and conduct any combat operations is not included and must be added. The time that elapses between the day that the WMD-owning regime falls and U.S. forces secure active weapons sites represents a risk “window” (shown in the figure) for proliferating WMD and related materials.

The total campaign length can also be shortened by a number of factors. First, the coalition might increase the number of TFs available to secure sites. Second, some sites may be very small and—depending upon security at these sites—it may be possible to split a battalion TF into company- and platoon-sized units to explore more sites in

Figure S.2
Nominal Time Needed to Complete WMD-E Operations Through the Exploitation Phase

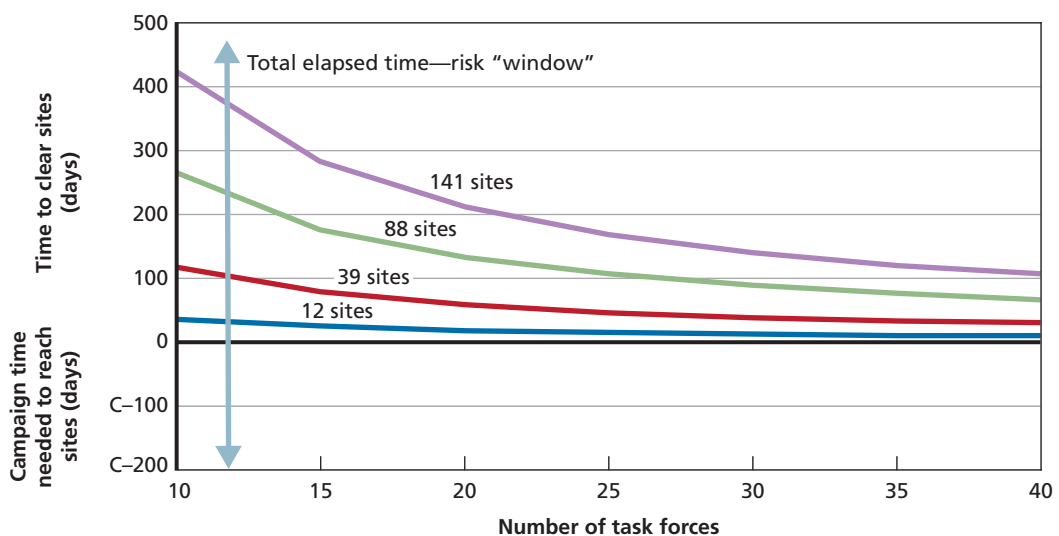

parallel. Some sites may be “dry holes”—and if this can be determined quickly, it may be possible to reduce the time needed at them. It may also turn out that several sites are aggregated together and can be exploited by the same TF.

Finally, allies, coalition partners, and Chinese forces might search some DPRK WMD sites, reducing the demands on U.S. forces. One caveat: The United States would want to ensure these partner forces were diligent and complete in their exploitation efforts—and in securing seized weapons or materials from subsequent theft by terrorist or criminal organizations.

Concluding Observations

Although DoD has made important progress in developing some of the *ways* of countering WMD—developing relevant doctrine, concepts of operation, and organizational templates for counter-WMD missions—there is little comparable evidence that DoD has adequately considered the *means* that may be required to address the counter-WMD mission and, perhaps especially, the WMD-E mission area and its ground force requirements. The analyses presented here indicate that the ground force requirements associated with WMD-E and other counter-WMD missions could be quite substantial, potentially rivaling more traditional scenarios used as the basis for sizing military capacity and determining the military capabilities required.

To close this national strategy–resource policy gap, DoD should:

- promote countering WMD in general and WMD-E in particular to the status of missions that drive resourcing priorities—in terms of both military capacity (force size) and the development of military capabilities (force structure)
- assess the force requirements for counter-WMD and WMD-E missions across a wide range of scenarios and in contingency and operational campaign planning
- perform a capabilities gap analysis of counter-WMD and WMD-E operations within the Joint Capabilities Integration Development System.

Furthermore, DoD should evaluate counter-WMD and WMD-E force requirements in current and future defense reviews—paying particular attention to the risks associated with WMD-E operations, given the simultaneous missions that need to be performed. To this end, DoD should also assess the number of large WMD-E TFs needed for simultaneous WMD-E operations within a single, large, counter-WMD scenario. Finally, this report suggests that the size, complexity, joint nature, and strategic importance of WMD-E operations will require that DoD assign a JTF headquarters capable of commanding maneuver, WMD-E, logistics, and potentially combat operations. Because it would combine WMD specialists with a large number of combat and support forces, this could not be a strictly specialized formation. Because a WMD-E

mission could happen on short notice, these headquarters would need to be prepared to execute it with little preparation. And because JTF-capable headquarters are few, the WMD-E mission could not be the only mission for such an outfit.

The Army should consider preparing each of its three corps for this mission. Since I and III Corps have geographically focused missions, they would be the logical choice to act as JTF-Elimination in the Pacific Command and Central Command theaters, respectively, while the XVIII Airborne Corps could be available worldwide. Each would need to train for this mission, and with the specialized units and other capabilities not part of a corps' normal battle rhythm.

Also, the Army needs to develop alternative concepts of operations for conducting WMD-E operations in a joint campaign. It should also assess the number of simultaneous WMD-E TFs that could be supported by existing and planned technical units. Finally, the Army should decide on roles, missions, component mixes, and training requirements for countering WMD to ensure that sufficient TFs are ready and available to perform this important national strategic mission.

Simultaneously, the Army should assess mobility requirements for counter-WMD and WMD-E operations, including options to reduce the time required to deploy capabilities into theater and the desirability of prepositioning WMD-E TF units, as well as early deployment of long-dwell ISR assets or unmanned combat air vehicles.

The Army cannot redress gaps in countering WMD on its own or by itself—the need for joint, even combined, forces is paramount and clear—but neither can these national strategy–resource policy gaps be closed sufficiently, much less fully, without the Army, whose force capacity and capabilities—properly resourced—are essential to the task.

Acknowledgments

The authors would like to thank key Army leaders for providing their thoughtful review. These include Mr. Dan Klippstein and Colonel Todd Key (G-35), MG John Rossi and Mr. Tim Muchmore (G-8/QDRO), Colonel Brad Gericke (Chief of Staff Coordination Group), and LTG (ret) James Dubik. In addition, we would like to thank RAND colleagues Terrence Kelly, Brian Nichiporuk, Tom McNaugher, Bruce Held, Bruce Bennett, James Quinlivan, and Tom Szyana, and RAND Arroyo Army Research Fellows Keith Walters, Peter Rasmussen, and Joel Verneti, for their excellent reviews, comments, and other assistance.

Abbreviations

AAMDC	Army Air and Missile Defense Command
AC	active component
ACE	Area for Capability Enhancement
AOR	area of responsibility
ARB	attack reconnaissance battalions
BCT	brigade combat team
BOG	boots on the ground
BW	bioweapons
C2	command and control
CAB	combat aviation brigade
CARA	CBRNE Analytical and Remediation Activity
CBRN	chemical, biological, radiological, and nuclear
CBRNE	chemical, biological, radiological, nuclear, and explosives
CCDR	combatant commander
CCMRF-CBRNE	Consequence Management Response Force-CBRNE
C-Day	day upon which forces are committed to an operation
CERS	Centre D'Etude et Recherché Scientifique
CFACC	Combined Forces Air Component Commander
CONOPS	concept of operations
CPRC	Counterproliferation Program Review Committee
CRT	CBRN response team
CTR	Cooperative Threat Reduction
CW	chemical weapons

DCI	Director of Central Intelligence
DMPI	desired mean point of impact
DMZ	demilitarized zone
DoD	Department of Defense
DPRK	Democratic Peoples Republic of Korea (North Korea)
DSG	Defense Strategic Guidance
EAB	echelon-above-brigade
GAO	General Accounting Office
GCC	geographic combatant command
IAEA	International Atomic Energy Agency
INVO	Iraq Nuclear Verification Office
ISG	Iraq Survey Group
ISIS	Institute for Science and International Security
ISR	intelligence, surveillance, and reconnaissance
JFC	joint force commander
JFLCC	joint force land component commander
JIC	joint integrating concept
JTF	joint task force
JTF-E	Joint Task Force–Elimination
LOC	lines of communication
MET	mobile exploitation team
NATO	North Atlantic Treaty Organization
NPRR	Nuclear Posture Review Report
NTI	Nuclear Threat Initiative
ODNI	Office of the Director of National Intelligence
ODS	Operation Desert Storm
OEF	Operation Enduring Freedom
OIF	Operation Iraqi Freedom
OPCW	Organization for the Prohibition of Chemical Weapons
QDR	Quadrennial Defense Review (Report)
QRF	quick reaction force
RC	reserve component

RoK	Republic of Korea
SJFHQ-E	Standing Joint Force Headquarters–Elimination
SOF	special operations forces
SRBM	short-range ballistic missile
TBM	theater ballistic missile
TEL	transporter-erector-launcher
TF	task force
TST	time-sensitive target
TTP	tactics, techniques, and procedures
UN	United Nations
UNMOVIC	United Nations Monitoring, Verification and Inspection Commission
UNSCOM	United Nations Special Commission
USSTRATCOM	U.S. Strategic Command
WMD	weapons of mass destruction
WMD-E	WMD-elimination
XTF	exploitation task force

Introduction

Although two successive presidents have determined that weapons of mass destruction (WMD)—particularly nuclear weapons in the hands of violent extremists—pose the greatest threat to the American people, and have decided that countering their proliferation is a top strategic priority, their administrations have not made countering WMD a priority when it comes to allocating budgetary resources to that overarching national mission. On the one hand, for example, the Department of Defense (DoD) has proclaimed that countering the proliferation of WMD is a primary mission of the U.S. military. On the other hand, DoD has decided that countering the proliferation of WMD will not drive the military capacity (force size) or military capabilities (force structure) of U.S. forces. Such decisions have led to a potentially critical gap between the strategic importance of countering the proliferation of WMD, as expressed in national strategy documents, and actual DoD policy, which accords low priority in the Defense Strategic Guidance (DSG) and in DoD’s recent budgets for the resources actually allocated to this mission.

To be sure, the United States has made important progress in diplomatic efforts to reduce WMD threats cooperatively. It has also continued to invest in defenses against ballistic missile attack, and it is developing capabilities to help mitigate the consequences of any WMD event. However, relatively little investment has been made in the forces and capabilities needed to eliminate WMD arsenals vulnerable to theft as a result of civil war (e.g., in Syria), state failure (e.g., a collapse of the North Korean regime), or other pathways to the loss or transfer of WMD (e.g., in Pakistan). This is a critical gap—since failure to deal effectively with such arsenals and, if possible, secure or eliminate them may be the most likely way in which violent extremists gain nuclear, biological, or chemical weapons (CWs).

In this report, we focus primarily, though not exclusively, on the need to secure and eliminate WMD—i.e., on the WMD-elimination (WMD-E) mission area. Why this particular focus? First, elimination of highly threatening WMD is, in a real sense, the ultimate mission, the one toward which all the other WMD mission areas discussed in this document—active and passive defenses, interdiction, offensive operations, and quick action to seize and secure suspected sites—point, and against which, in effect, they are all assessed. In the end, getting these most-dangerous weapons out

of the hands of highly threatening states and people—and keeping them out of their hands by getting rid of them—is what these missions are all about. The second reason we focus mainly on WMD-E is because our analysis of countering WMD, as the title of this document indicates, addresses the question of what the U.S. Army can contribute to this overarching national security strategic priority. We think it makes sense, therefore, to concentrate the bulk of our efforts in this report on the one mission area—WMD-E—for which the Army seems best suited and, thus, most likely to play a leading role.

Unfortunately, little analysis exists in the public domain that assesses the capacity and capabilities required by military forces to conduct WMD-E operations. As a result, public discussion of what capabilities the military requires for such operations generally omits or gives short shrift to requirements for the critical WMD-E mission. One main purpose of this report is to address and analyze those requirements; namely, the ground force capacity (force size) and capabilities (force structure) needed to accomplish WMD-E missions and tasks. Because any analysis of specific scenarios, forces, and capabilities tends to be classified, the analyses documented in this report rely on publicly available sources and methods to describe generalized scenarios. We use these scenarios to conduct parametric analyses of the types of force structure required to carry out WMD-E missions. Although our analyses do not result in detailed campaign plans, they do provide readers and policymakers with an informed description of the types and size of ground forces required to conduct WMD-E operations in a wide range of situations. This analysis, as well as key findings flowing from it, is featured in subsequent chapters of this report.

Gap Between WMD Proliferation Threats and Resourcing Priorities

In Chapter Two, we assess the gap between the high priority accorded the threat of WMD proliferation in national strategy documents and the low priority for resources allocated to countering WMD by DoD. In the context and via the concepts of national security *ends*, strategic *ways*, and resource policy *means*, we note again that two successive administrations—one Republican, the other Democratic—have proclaimed that WMD proliferation poses the greatest of threats to U.S. national security—particularly nuclear weapons in the hands of terrorists or violent extremists. Furthermore, both administrations have listed countering the proliferation of WMD—especially nuclear weapons—as a top national priority (a strategic *end*).

We observe in Chapter Two that there appears to be a serious gap between the urgency of this WMD threat and DoD's resource priorities (policy *means*). The DSG does not elevate countering WMD to the status of threats that drive military capacity or military capabilities. DoD's *Defense Budget Priorities and Choices* does name special operations forces (SOF) as critical capabilities in relation to the counterproliferation

mission. However, even though SOF do provide critical counterproliferation capabilities, a much larger and more comprehensive capability will be needed to eliminate WMD that might be exposed to theft or proliferation if a WMD state were to collapse. Furthermore, we point out in Chapter Two, neither the 2010 Quadrennial Defense Review (QDR) nor its 2014 successor list a counterproliferation mission among the scenarios used to determine strategic risk—in other words, it missed an opportunity to determine the campaign-level capabilities needed to deal with large-scale WMD programs.

On the matter of funding, Chapter Two notes that recent DoD budget requests include approximately \$19 billion for combating WMD. However, most of this money is directed toward active defense (a strategic *way*)—primarily ballistic missile defense programs; the remainder is allotted to other counter-WMD programs (various strategic *ways*) but under tight resource controls that feature fixed, unchanging budget shares. Very little—less than 2 percent—appears to be allocated to eliminating WMD stockpiles, which are potentially vulnerable to theft, or to interdicting them in transit. This omission is particularly worrisome, Chapter Two concludes, in the event that a WMD state lost control of its arsenal.

Past Counter-WMD and Potential Future WMD-E Operations

In Chapter Three, we discuss past counter-WMD operations in Iraq and potential challenges for future operations—in particular, those involving WMD-E. For example, during Operation Desert Storm (ODS) and again during Operation Iraqi Freedom (OIF), U.S. and coalition forces found it very difficult to find and destroy ballistic missiles still on their launchers—with no confirmed destructions during ODS and perhaps four in OIF. Destroying weapons not on launchers and conducting WMD-related industrial operations may be even harder. Despite a significant effort in ODS, thousands of munitions and millions of liters/thousands of metric tons of chemical warfare agents and precursors were left untouched by the air campaign.¹ Chapter Three points out that the record on WMD-E operations is even worse. During OIF, such operations were hastily conceived, significantly underresourced, and pretty much unable to rapidly seize, secure, and search suspected sites.

Today, Chapter Three observes, states such as North Korea pose a WMD threat to their neighbors and even to their own citizens. If these states were to collapse, their WMD and related facilities would be exposed to theft and sale to other states or vio-

¹ The United Nations Monitoring, Verification and Inspection Commission (UNMOVIC) supervised the destruction of 411 metric tons of bulk chemical weapon (CW) agents, about 300 metric tons of weaponized agents, and 2,850 metric tons of key CW precursor chemicals. Some 1,000 additional metric tons of material were destroyed unilaterally by Iraq or during the coalition air campaign. UNMOVIC, *Compendium of Iraq's Proscribed Weapons Programmes in the Chemical, Biological and Missile Areas*, New York, June 2007, pp. 326–333.

lent groups, thus posing a grave and urgent threat to the United States, its allies, and friends. As an example, in a violent collapse of North Korea, that country's artillery is in position to inflict tens of thousands of casualties via conventional munitions. With chemical munitions, civilians will be at even greater risk—since those taking shelter in underground facilities could be exposed to chemical agents. Worse yet, a single nuclear weapon delivered into a large city by aircraft, ballistic missiles, or covert forces has the potential to inflict an order of magnitude more casualties.

To counter these actions, Chapter Three contends, U.S. and coalition forces must be ready to conduct the full range of counter-WMD missions (the various strategic *ways*)—including active and passive defenses, interdiction, offensive operations, quick action to seize and secure suspected sites, and WMD-E operations. Counter-WMD operations should culminate in the WMD-E mission—resulting in the seizure and elimination of WMD and their related components, materials, and facilities. It is in Chapter Three, therefore, that we begin focusing our attention and analysis primarily on the WMD-E mission area.

Chapter Three also suggests that U.S. and coalition forces should be prepared to counter adversary actions to defeat the WMD-E mission or to render it ineffective. Adversary actions might include moving and hiding WMD and related components, attacking entering forces with WMD, dismantling key production equipment for later sale, and proliferating weapons and components once U.S. and coalition forces depart. The level of threat posed by regime remnants will be a significant factor—potentially ranging from uncertain opposition from low-threat regime survivors to openly hostile adversaries posing a high threat to mission success. Time is another key factor; for example, each passing day increases the risk that weapons or components will be smuggled out of North Korea and sold.

We argue in Chapter Three that the WMD-E mission should be performed by a joint and multinational force, with a distinctly subordinate joint task force (JTF) being assigned the WMD-E mission. This JTF should include specially trained and equipped task forces (TFs) to enter each site, as well as enough maneuver forces to seize and secure sites against adversary military actions. Metrics for mission success are proposed and analyzed in this chapter. They include such yardsticks as the number of weapons and the percentage of key components, materials, equipment, and information recovered, plus the number of personnel debriefed.

Illustrative WMD-E Scenarios and Associated Ground Force Requirements

Recent events in Syria raised the possibility that the United States and its allies could have been faced with eliminating Syrian CWs, although the United States has declared

that the Syrian CW program has been destroyed.² North Korea presents an even more worrisome prospect—it too has an extensive CW program, but it has also detonated up to three nuclear devices. If North Korea collapses, these nuclear weapons would pose an especially grave threat to nations around the world if they were to fall into the hands of terrorists.

In Chapter Four, we assess the WMD-E mission parametrically; in the process, we make use of two scenarios: one involving Syria; the other, North Korea. For each scenario, we vary the number and size of WMD sites in the notional target sets, the threat level in the operational environment, and the assumed ratio of supporting forces to WMD-E mission forces. Our assessment in Chapter Four concludes that WMD-E ground force requirements in scenarios like these could be quite substantial, even under modestly favorable assumptions; under more demanding (and probably more realistic) conditions, force requirements could be even higher.

Finally, we estimate in Chapter Four that WMD-E operations in the Democratic Peoples Republic of Korea (DPRK) could take anywhere from several months to more than a year to complete. The time needed depends upon the number of WMD sites searched, the number of TFs that DoD provides, and the average rate at which the WMD-E TFs can complete their operations.

Concluding Observations and Recommendations for DoD and the Army

In Chapter Five, we present our recommendations for DoD and the U.S. Army. Given the national importance of the counter-WMD mission, as well as the potentially large demand for ground forces to accomplish the WMD-E mission, we recommend that WMD-E begin serving as a driving mission for DoD force capacity (size) and capability (structure) decisions, the education and training of prospective joint force commanders (JFCs), and the organization, training, and equipping of forces. Furthermore, we recommend several additional actions that DoD and the Army should take to identify, assess, and close WMD-E capability gaps. The last of our concluding observations in Chapter Five is that the Army cannot redress gaps in countering WMD on its own or by itself—the need for joint, even combined, forces is paramount and clear—but neither can these national strategy–resource policy gaps be closed sufficiently, much less fully, without the Army, whose force capacity and capabilities—properly resourced—are essential to the task.

² See Alan Rappeport, “Syria’s Chemical Arsenal Fully Destroyed, U.S. Says,” *New York Times*, August 18, 2014.

Appendixes

Attached to the main report we have included additional material in several appendixes:

- Appendix A provides detailed discussions of current doctrine, including several documents describing WMD-E operations at a conceptual level.
- Appendix B provides further analysis of WMD-E missions within the DPRK and Syria.
- Appendix C provides additional details on the troop numbers needed for WMD-E TFs.
- Appendix D describes our analysis of support requirements for WMD-E TF operations.

A separate, limited-distribution document includes two additional appendixes (E and F). They are not available to the general public because they contain analysis based on information with restricted distribution.

Gaps Between Countering WMD and Prioritizing Resources

In this chapter, we review national security strategy, policy, and planning documents to show that the *ends* of countering WMD have consistently been accorded the highest level of strategic importance by the United States.¹ In addition, DoD has developed some of the ways to counter WMD—in terms of doctrine; tactics, techniques, and procedures (TTP); and concepts. DoD also has made efforts to improve some of the *means* for accomplishing this mission, in terms of specialized headquarters and technologies.

However, DoD to date has generally failed to bring its policies—i.e., the *ways* and *means* to accomplish strategic missions—into line with the national security strategy and mission of countering WMD—i.e., the *ends* in this case. Nor has DoD really grappled with the potential scope or with the scale of the *ways* and *means* required to accomplish this strategic mission. We discuss these issues in this chapter, as well.

National Strategy Documents: WMD Proliferation—The Greatest Threat

National strategy documents have consistently stressed the overarching importance of countering weapons of mass destruction.² In 2002, the White House issued both its first National Security Strategy and the National Strategy to Combat Weapons of Mass Destruction. The 2002 National Security Strategy states that:

The gravest danger to freedom lies at the crossroads of radicalism and technology. When the spread of chemical and biological and nuclear weapons, along

¹ National and defense policy documents use the terms “counter-WMD,” “combating WMD,” and “counterproliferation” operations. “Combating” includes nonproliferation activities led by the State Department, consequence management activities led by the Department of Homeland Security, and counterproliferation activities led by DoD. We will use each term as specified in the documents we discuss. In all other places we will use “counter-WMD” for the set of missions—including WMD-E—assigned to the military.

² See Appendix A for a more thorough presentation of selected national security strategy documents, as well as joint and service documents.

with ballistic missile technology—when that occurs, even weak states and small groups could attain a catastrophic power to strike great nations. Our enemies have declared this very intention, and have been caught seeking these terrible weapons. They want the capability to blackmail us, or to harm us, or to harm our friends—and we will oppose them with all our power.³

The National Strategy to Combat Weapons of Mass Destruction further stated that “weapons of mass destruction (WMD)—nuclear, biological, and chemical—in the possession of hostile states and terrorists represent one of the greatest security challenges facing the United States. We must pursue a comprehensive strategy to counter this threat in all of its dimensions . . .”⁴ The document went on to say:

Weapons of mass destruction could enable adversaries to inflict massive harm on the United States, our military forces at home and abroad, and our friends and allies. Some states, including several that have supported and continue to support terrorism, already possess WMD and are seeking even greater capabilities, as tools of coercion and intimidation. For them, these are not weapons of last resort, but militarily useful weapons of choice intended to overcome our nation’s advantages in conventional forces and to deter us from responding to aggression against our friends and allies in regions of vital interest.

In addition, terrorist groups are seeking to acquire WMD with the stated purpose of killing large numbers of our people and those of friends and allies—without compunction and without warning . . .

We must accord the highest priority to the protection of the United States, our forces, and our friends and allies from the existing and growing WMD threat.⁵

It is therefore critical that the U.S. military and appropriate civilian agencies be prepared to deter and defend against the full range of possible WMD employment scenarios. We will ensure that all needed capabilities to combat WMD are fully integrated into the emerging defense transformation plan and into our homeland security posture. Counterproliferation will also be fully integrated into the basic doctrine, training, and equipping of all forces, in order to ensure that they can sustain operations to decisively defeat WMD-armed adversaries.⁶

³ George W. Bush, West Point, New York, June 1, 2002, as quoted by the White House, *The National Security Strategy of the United States of America*, September 2002a.

⁴ The White House, *National Strategy to Combat Weapons of Mass Destruction*, Washington, D.C., December 2002b.

⁵ The White House, 2002b.

⁶ The White House, 2002b, p. 2.

The National Security Strategy issued in 2010 built upon the threat posed by weapons of mass destruction, and especially nuclear weapons, proclaiming that “This Administration has no greater responsibility than the safety and security of the American people. And there is no greater threat to the American people than weapons of mass destruction, particularly the danger posed by the pursuit of nuclear weapons by violent extremists and their proliferation to additional states.” This 2010 document continued:

The American people face no greater or more urgent danger than a terrorist attack with a nuclear weapon. And international peace and security is threatened by proliferation that could lead to a nuclear exchange. Indeed, since the end of the Cold War, the risk of a nuclear attack has increased. Excessive Cold War stockpiles remain. More nations have acquired nuclear weapons. Testing has continued. Black markets trade in nuclear secrets and materials. Terrorists are determined to buy, build, or steal a nuclear weapon. Our efforts to contain these dangers are centered in a global nonproliferation regime that has frayed as more people and nations break the rules.⁷

Also in 2010, the *Quadrennial Defense Review Report* (QDR) published in February of that year confirmed that “The proliferation of weapons of mass destruction (WMD) continues to undermine global security, further complicating efforts to sustain peace and prevent harmful arms races. The instability or collapse of a WMD-armed state is among our most troubling concerns. Such an occurrence could lead to a rapid proliferation of WMD material, weapons, and technology, and could quickly become a global crisis posing a direct physical threat to the United States and all other nations.” The 2010 QDR further stated that the “potential spread of weapons of mass destruction poses a grave threat.” It concluded that “preventing the proliferation and use of such weapons is therefore a top national priority for which many federal agencies have important responsibilities.”⁸

Finally, in January 2012, the DSG added the following:

The proliferation of nuclear, biological, and chemical weapons technology has the potential to magnify the threats posed by regional state actors, giving them more freedom of action to challenge U.S. interests. Terrorist access to even simple nuclear devices poses the prospect of devastating consequences for the United States. Accordingly, *the Department of Defense will continue to enhance its capabilities, acting with an array of domestic and foreign partners, to conduct effective operations to counter the proliferation of WMD.* (Emphasis in original)⁹

⁷ The White House, *National Security Strategy*, Washington, D.C., May 2010, pp. 4, 23.

⁸ DoD, *Quadrennial Defense Review Report*, Washington, D.C., February 2010a, pp. iv, 23.

⁹ DoD, *Sustaining U.S. Global Leadership: Priorities for 21st Century Defense*, Washington, D.C., January 2012b, p. 3. This document conveys the 2012 DSG.

Building on this emphasis in the 2012 DSG, the most recent QDR, published in 2014, notes that terrorist networks “continue to demonstrate interest in obtaining WMD”¹⁰ and that global “prevention, detection, and response efforts are essential to address dangers across the WMD spectrum before they confront the homeland.”¹¹ DoD remains committed, the 2014 QDR reaffirms, “to funding global cooperative efforts to reduce proliferation and threats of WMD”; such efforts include “preventing the acquisition of, accounting for, securing, and destroying as appropriate WMD abroad—a process that is ongoing in Syria.”¹²

Some official statements in the current decade have even suggested that countering the proliferation of WMD has eclipsed the traditional nuclear deterrence and warfighting mission. For example, the *Nuclear Posture Review Report* (NPRR) for April 2010 placed the prevention of nuclear terrorism and proliferation at the top of the U.S. policy agenda,¹³ and in testimony in January 2012, General C.R. Kehler, commander of U.S. Strategic Command (USSTRATCOM), testified that “the threat posed by WMD in the hands of violent extremists transcends all of USSTRATCOM’s priorities and encompasses every geographic area of responsibility (AOR).”¹⁴

Countering WMD—Ends, Ways, and Means

National Security “Ends”

The overarching strategic goal of U.S. counter-WMD efforts, therefore, is to “ensure that states and nonstate actors cannot coerce or attack the United States, its forces, or its allies, partners and interests with WMD.”¹⁵

Strategic “Ways”

Together, the National Strategy to Combat WMD and the National Military Strategy to Combat WMD describe three “pillars” and eight military “mission areas” for combatting WMD:

- Three pillars of national strategy to combat WMD:
 - counterproliferation to combat WMD use

¹⁰ DoD, *Quadrennial Defense Review 2014*, Washington, D.C., March 2014, p. 8

¹¹ DoD, *QDR 2014*, p. 16

¹² DoD, *QDR 2014*, p. 16

¹³ DoD, *Nuclear Posture Review Report*, Washington, D.C., April 2010b, p. i.

¹⁴ General C.R. Kehler, “Statement of General C. R. Kehler, Commander, United States Strategic Command, Before the House Committee on Armed Services, Subcommittee on Strategic Forces,” April 17, 2012.

¹⁵ Chairman, Joint Chiefs of Staff, *National Military Strategy to Combat Weapons of Mass Destruction*, Washington, D.C., February 2006, p. 8.

- nonproliferation to combat WMD proliferation
- consequence management to respond to WMD use.
- Eight mission areas of the national military strategy to combat WMD:
 - offensive operations
 - elimination
 - interdiction
 - active defense
 - passive defense
 - WMD consequence management
 - security cooperation and partner activities
 - threat reduction cooperation.

Nonproliferation features diplomatic efforts and includes the Cooperative Threat Reduction Program—as well as the Proliferation Security Initiative, launched in 2003 as a global effort to locate, monitor, track, interdict, and secure WMD and related components.¹⁶ These are important efforts; if enough time and attention are devoted to them, and they are backed by sufficient political will to continue pursuing them in difficult circumstances (e.g., the Organization for the Prohibition of Chemical Weapons [OPCW] in Syria today), as well as by appropriately attractive incentives (e.g., suspension of sanctions—as in the case with Libya), such initiatives can perform a vital function. However, nonproliferation efforts by themselves may not be able to effectively deal with a state at war with its neighbors or to safeguard a WMD arsenal made vulnerable to theft by a state collapse.

Consequence management within the United States features the Department of Homeland Security with the military in a supporting role. It aims to reduce the effects of WMD use on affected forces and populations. For its part, DoD has directed the Army to stand up a large and capable response force to assist civilian authorities at home and allies abroad.¹⁷

Counterproliferation is the primary counter-WMD responsibility of military forces. It comprises “the full range of operational capabilities to counter the threat and use of WMD by states and terrorists,”¹⁸ including “preventing the proliferation and use

¹⁶ The Proliferation Security Initiative aims to “establish a more coordinated and effective basis through which to impede and stop shipments of WMD, delivery systems, and related materials flowing to and from states and nonstate actors of proliferation concern.” The White House, *Proliferation Security Initiative: Statement of Interdiction Principles*, fact sheet, Office of the Press Secretary, Washington, D.C., September 4, 2003.

¹⁷ U.S. Department of the Army, *2009 Army Posture Statement*, Information Papers, CBRNE Consequence Management, May 2009: “On October 1, 2008, the Army assigned approximately 2,900 of the 4,700 Department of Defense (DoD) personnel to the Commander, United States Northern Command (USNORTHCOM) for [CBRNE Consequence Management Response Force] CCMRF-One. The Army CCMRF forces include robust command and control (C2), comprehensive decontamination of personnel and equipment, hazardous material handling and disposal, air and land transportation, aerial evacuation, and sustainment.”

¹⁸ The White House, 2002b, p. 2.

of nuclear, biological, and chemical weapons.”¹⁹ These activities consist of five mission areas featuring military forces in a leading role:

- *WMD Offensive Operations* comprises the “detection, identification, disruption, and/or destruction of an adversary’s WMD assets, means of delivery, associated facilities, and other high-value targets.”²⁰ This includes raids, strikes, and other actions to prevent, pre-empt, or defeat the employment of WMD.
- *WMD-Elimination* includes operations to “systematically locate, characterize, secure, disable, and/or destroy a State or non-State actor’s WMD programs and related capabilities in hostile or uncertain environments.” Notably, the strategy states that DoD “must develop, institutionalize, and exercise a joint capability to eliminate WMD in uncertain environments,” including integrating this mission into doctrine, organization, and training, and that commanders should be “prepared to conduct elimination activities from the initiation of operations” until they can be transferred to another agency.
- *WMD Interdiction Operations* comprise tracking, intercepting, searching for, and seizing WMD and related components in transit. This includes terrorist, criminal, and covert movements of WMD, materials, components, and technical experts.
- *WMD Active Defense* includes measures to defeat an attack such as air and missile defense and defenses against unconventionally delivered WMD.
- *WMD Passive Defense* seeks to minimize or negate vulnerability and the effects of WMD use.

Resource Policy “Means”

Although the DSG includes countering WMD proliferation among the ten primary missions of the U.S. military,²¹ it does not elevate this mission to those that drive mili-

¹⁹ DoD, 2012b, p. 5.

²⁰ Chairman, Joint Chiefs of Staff, 2006, p. 8.

²¹ The January 2012 DSG identifies ten primary missions of the U.S. military, highlighting the following four as those that drive requirements for the development of military capacity:

- counter terrorism and irregular warfare
- deter and defeat aggression
- maintain a safe, secure, and effective nuclear deterrent
- defend the homeland and provide support to civil authorities.

Missions shaping the future Joint Force, but not driving capacity requirements include:

- Project Power Despite Anti-Access/Area Denial Challenges
- **Counter Weapons of Mass Destruction** (emphasis added)
- Operate Effectively in Cyberspace and Space
- Provide a Stabilizing Presence
- Conduct Stability and Counterinsurgency Operations
- Conduct Humanitarian, Disaster Relief, and Other Operations.

tary capacity, which means that building the capacity and force structure needed to accomplish it is not a priority for the services.

For its part, DoD's *Defense Budget Priorities and Choices Fiscal Year 2014* includes a single mention of WMD as it relates to the counterproliferation mission set of SOF,²² but, like the DSG, it also does not list the counter-WMD mission area as a priority area for budget resources or capability enhancement. Furthermore, scenarios featured in the 2010 and 2014 QDRs did not include a counter-WMD proliferation mission.²³ Without such campaign-level assessments, it is hard to understand the joint force requirements of such missions, not to mention the timelines that may be required to effectively secure and prevent the proliferation or use of WMD.²⁴

In the absence of resource policy priorities for countering WMD, DoD spending to enhance capabilities for this mission and the five mission areas noted above has focused primarily upon active defense and offensive capabilities. Spending on combating WMD in recent years was estimated at \$19 billion in 2010, with more than 50 percent going to "active defense" (primarily missile defense), 25 percent to "offensive" activities, and about 10 percent to "passive defense."²⁵

These are arguably important investments to counter-WMD that could be employed by hostile state threats. Missile defense would be an important capability when confronting a belligerent or failing state. Offensive operations could help prevent the use of WMD, and passive defenses could work to minimize their effects if used. We will discuss some of the benefits and limitations of each of these missions in Chapter Three; for now, it is sufficient to note that three of the five mission areas (*ways*) listed above—offensive operations, active defense, and passive defense—figure prominently in policy and resource decisions (*means*) related to national strategic priorities (*ends*), even if one argues that the resource policy priorities accorded them should be higher or lower.

Unfortunately, the bulk of the investments currently being made in these three mission areas do not directly address the employment of WMD by covert groups, nor

²² DoD, *Defense Budget Priorities and Choices: Fiscal Year 2014*, Washington, D.C., April 2013a, p. 29.

²³ The scenario combinations that were tested are detailed on pp. 42–43 of the 2010 QDR (DoD, 2010a) and p. 22 of the 2014 QDR (DoD, 2014). DoD's *Combating Weapons of Mass Destruction* provides a rich illustration of the ways that WMD missions might be integrated into different types of campaigns. See DoD, *Combating Weapons of Mass Destruction*, Washington, D.C., JP 3-40, June 10, 2009, Chapters IV and V.

²⁴ Indeed, it is quite plausible that the time sensitivity and urgency of counter-WMD operations is much higher than that for many missions that are currently being used to estimate force requirements.

²⁵ For reporting on DoD spending on combating WMD, see U.S. Government Accountability Office (GAO), *Weapons of Mass Destruction: Actions Needed to Track Budget Execution for Counterproliferation Programs and Better Align Resources with Combating WMD Strategy*, Washington, D.C., GAO-10-755R, September 28, 2010, esp. pp. 6–8; Under Secretary of Defense for Acquisition, Technology, and Logistics (USD(AT&L)/Counterproliferation Program Review Committee, *Report on Activities and Programs for Countering Proliferation and NBC Terrorism*, Vol. I, Executive Summary, May 2011, p. 35.

the acquisition of WMD by states or terrorists who have looted or bought weapons from failed states. To counter these threats, the United States would require the ability to eliminate WMD arsenals in failed states and to interdict the employment of weapons that covert or terrorist groups do succeed in obtaining. Currently, only 1 percent of DoD spending to counter WMD goes to “elimination” and less than 1 percent goes to “interdiction.”²⁶ Big gaps clearly exist, therefore, between the low priorities for resourcing—i.e., for providing the *means* to pursue—these two mission areas (or *ways*) and the high priority accorded the national strategic *ends* they are supposed to be serving. In no uncertain terms, it seems fair to conclude, a national strategy–resource policy mismatch pervades and undercuts both current plans and potential future efforts to counter WMD via elimination and interdiction.

DoD and Army Investments in Doctrine and Organization

In contrast to the strategy-policy mismatch related to resources, the situation is different when doctrine and organization are taken into account. In these areas, provision has been made—means have been developed—for pursuing the ends involved in countering WMD proliferation.

Doctrine

The geographic combatant commanders have the task of planning and executing counter-WMD operations within their respective AORs and incorporating them into their plans. This includes preparing strategic estimates, priorities, and plans for joint operations, as well as coordinating the transition of operations to other multinational forces or nation-states.²⁷ DoD notes that it may be necessary to establish a JTF for counter-WMD operations.²⁸ Such JTFs could focus on executing a single counter-WMD mission, such as WMD-E, or could execute several counter-WMD missions.²⁹ Currently, the 20th Support Command is tasked with providing the nucleus for such a counter-WMD JTF.³⁰

Joint counter-WMD actions and activities can occur in permissive, uncertain, and hostile environments, and their planning and execution need to be integrated into all types of operations across the range of military operations.³¹ The JFC leverages

²⁶ GAO, 2010, p. 7.

²⁷ DoD, 2009, pp. III-1 to III-2.

²⁸ DoD, 2009.

²⁹ DoD, 2009, pp. III-6 to III-10.

³⁰ See U.S. Army, *Chemical, Biological, Radiological, Nuclear, and High Yield Explosives Operational Headquarters*, HDQA, FMI 3-90.10, Change 1, February 2011.

³¹ DoD, 2009, pp. IV-4 to IV-5.

necessary capabilities from all six joint warfighting functions during a campaign to achieve the desired counter-WMD effects and objectives.³² WMD-E and other counter-WMD missions are conducted by a TF that is subordinate to the larger joint force.

The defense community has begun to develop a joint integrating concept (JIC), a WMD-E concept of operations (CONOPS), and joint and Army doctrine for technical aspects of the WMD-E missions.³³ These documents highlight some of the tasks required for WMD-E operations, as well as providing some of the necessary tactical and technical details. At present, however, these documents do not clearly state the capabilities needed to meet the ultimate end of eliminating a state's or group's ability to attack or coerce the United States and its allies with WMD. As we shall discuss in the next two chapters, these capabilities may be significant.

The mission of eliminating a state program before weapons proliferate cannot be reasonably assigned to technical headquarters alone. Such counter-WMD missions will require the broad and deep capabilities assigned to JFCs. The specific mission of finding, seizing, and securing weapons caches and facilities will require a combination of intelligence, surveillance, and reconnaissance (ISR); combat; mobility; logistics; and technical capabilities best employed by a permanently assigned JTF. To prepare these commands, combined-arms doctrine needs to explain more thoroughly how maneuver and supporting forces will be trained and organized to identify, consolidate, and eliminate captured WMD. In particular, to increase the joint commander's ability to focus limited WMD assets on the highest-payoff facilities, a more complete discussion is required of the intense military intelligence tasks that need to be conducted prior to and during joint operations to eliminate or interdict WMD. Finally, doctrine should also be strengthened by more detailed discussion of how to transition from JTFs focused on WMD interdiction or elimination to follow-on security and technical forces.

Notwithstanding these possibilities for improvement, existing doctrine for WMD elimination and interdiction, as with other joint and Army doctrine, provides the necessary intellectual framework for campaign design and planning, but—again, as with all doctrine—it does not provide answers to all of the problems that commanders may encounter, nor does it ensure that commanders will develop the necessary joint campaign plans needed to support WMD-E and interdictions operations.

Organization—An Army-Centric Example

In February 2012, USSTRATCOM stood up Standing Joint Force Headquarters—Elimination (SJFHQ-E), a small standing headquarters expected to reach its full operational capability by the end of 2013.³⁴ The SJFHQ-E is a command-and-control ele-

³² DoD, 2009, p. IV-6.

³³ See DoD, 2009, Appendix A, esp. p. A-3.

³⁴ See Kehler, 2012.

ment for a geographic combatant commander or JTF responsible for the elimination of WMD in uncertain or hostile conditions.³⁵ The SJFHQ-E is planned to have about 100 personnel and designed to assume the planning and coordination responsibilities of the Joint Elimination Coordination Element.³⁶ As described in a press release:

The SJFHQ-E will provide a full time, trained joint command and control element that can quickly integrate into a Geographic Combatant Command's (GCC) structure to provide WMD elimination expertise in planning, intelligence, and operations. This new headquarters will be a scalable, flexible, and deployable capability that can augment a GCC or existing Joint Task Force (JTF) headquarters staff, or be attached to a GCC as the core of the headquarters of a JTF established for elimination.³⁷

The U.S. Army's 20th Support Command (Chemical, Biological, Radiological, Nuclear, and Explosives, or CBRNE) serves as a core element of the SJFHQ-E, and has been collocated with the SJFHQ-E to facilitate development of a habitual relationship. Its mission statement is as follows:

The 20th Support Command (CBRNE) integrates, coordinates, deploys, and provides trained and ready CBRNE forces. Capable of exercising command and control of specialized CBRNE operations to support Joint and Army force commanders primarily for overseas contingencies and warfighting operations, but also in support of homeland defense. Maintains technical links with appropriate Joint, Army, Federal and State CBRNE assets, as well as the research, development, and technical communities to assure Army CBRNE response readiness.³⁸

³⁵ See Defense Threat Reduction Agency and U.S. Strategic Command Center for Combating Weapons of Mass Destruction, "DTRA, SCC-WMD and SJFHQ-E," Fact Sheet, May 2012, and USSTRATCOM, "Stand Up of SJFHQ-E Enhances Counter-WMD Mission," press release, February 6, 2012.

³⁶ According to USSTRATCOM: "The SJFHQ-E is predicted to have 61 full time Joint Service military billets and 37 Department of Air Force civilian billets." See USSTRATCOM, "Standing Joint Force Headquarters for Elimination," undated.

³⁷ USSTRATCOM, 2012. Joint doctrine on combating WMD describes a number of potential organizational models for subordinating a Joint Task Force–Elimination (JTF-E) to higher echelons, including reporting to the combatant commander (CCDR), a JFC, or a joint forces land component commander (JFLCC). See DoD, 2009, pp. III-6 to III-10.

³⁸ U.S. Army 20th Support Command home page. The 20th Support Command has substantial specialized capabilities for a range of WMD missions at home and abroad. Among its subordinate units are the 48th Chemical Brigade, 52nd Ordnance Group (EOD), 71st Ordnance Group (EOD), 111th Ordnance Group (EOD), the CBRNE Analytical and Remediation Activity (CARA), U.S. Army Reserve Consequence Management Unit, the Army Medical Laboratory, 21st Ordnance EOD (WMD) Company, four Nuclear Disablement Teams, and five WMD coordination element teams. In total, the 20th Support Command has three EOD Groups, one chemical brigade, 15 battalions, more than 85 companies, and one direct reporting activity. See U.S. Army 20th Support Command website.

Together, these headquarters units could provide tactical-level C2 of specialized technical units supporting WMD-E operations.³⁹ Efforts also have been made in DoD to identify and develop specialized WMD-E capabilities, including new technologies and niche units that can perform discrete WMD-E missions.

However—as important as these developments are—DoD still largely thinks of WMD-E missions as a combination of niche capabilities. The joint and Army headquarters established to date would not have sufficient expertise or scale to plan, integrate, and command and control all of the special operations and general purpose forces that may be needed for WMD-E operations in collapsed states.

Moreover, in reality, these capabilities must be embedded in larger JTFs capable of seizing and securing large sites in uncertain or hostile environments. As will be described in Chapter Four, the potential ground force requirements associated with counter-WMD operations in places like Syria and North Korea could be very large even under modestly favorable assumptions, and DoD will need to conduct detailed mission and campaign planning to ensure that the broad scope of tasks outlined in this chapter are adequately covered.⁴⁰

Summary

Given the importance placed on countering WMD in the National Security and the Defense Strategic Guidance, it is remarkable that the *ends* of this overarching mission do not drive the *ways* of and *means* for countering WMD more than they do. In particular, the overarching national security strategy for countering WMD appears to affect force structure and budgetary requirements (i.e., resource policy) minimally, if at all. Other *means* for countering WMD—that is, doctrine, organization, and contin-

³⁹ For a WMD-E CONOPS and description of a number of options for subordinating a WMD-E TF to a JTF, JFC, or JFLCC, see DoD, 2009, pp. III-6 thru III-10.

For example, *Multi-Service Tactics, Techniques, and Procedures for Weapons of Mass Destruction Elimination Operations* describes the notional organization of a company-sized TF for sensitive site operations, and battalion-sized TFs for WMD search-and-recovery, and sensitive site operations. U.S. Army, *Multi-Service Tactics, Techniques, and Procedures for Weapons of Mass Destruction Elimination Operations*, Washington, D.C., ATTP 3-11.23, December 2010. Not available to the general public.

⁴⁰ See, for example: “Could Countering the Spread of WMD Be the Army’s Next Big Thing?” *Inside the Army*, June 11, 2012; “Odierno: Army’s New Counter-WMD Mission Being Worked with SOCOM,” *Inside the Army*, June 25, 2012; “Counter-WMD Mission Again Mentioned as Yardstick in Army Force-Sizing,” *Inside the Army*, November 12, 2012; “Army TRADOC Pushes for More Expeditionary Force in Capstone Concept,” *Inside Defense Defense Alert*, December 20, 2012; “Unified Quest Wargame to Advance Army Operating Doctrine,” *Jane’s International Defence Review*, February 7, 2013; and “Army Heads into Joint Winter War Game Mulling Smaller, More Agile Force,” *Inside the Army*, February 11, 2013. In the summer of 2012, press reports suggested that Pentagon planners had estimated that 75,000 troops might be required to secure Syria’s WMD facilities and stockpiles. See, for example, David E. Sanger and Eric Schmitt, “Pentagon Says 75,000 Troops Might Be Needed to Seize Syria Chemical Arms,” *New York Times*, November 15, 2012.

gency and operational planning, as well as the education and training of JFCs—fare somewhat better, including for such mission areas or *ways* as WMD-E. On balance, however, significant gaps tend to dominate the relationship between national security strategy and resource policy when it comes to countering WMD. In the next chapter, we review two decades of historical experience dealing with Iraq’s WMD program, as well as current and potential future threats, to show that the capabilities required to fill these gaps could be quite substantial.

Counter-WMD Missions and WMD-E Operations

In Chapter Two we pointed out that DoD has identified countering WMD as one of its highest-priority missions and has developed new doctrine and some technical headquarters capabilities, but does not use requirements of the counter-WMD mission to drive military capacity.

In this chapter, we assess counter-WMD operations—in particular, the WMD-E mission—from several perspectives. First, we review the historical record of U.S. counter-WMD operations in OIF. Second, we examine currently looming threats, including the time imperatives associated with them. Third, we explore the various counter-WMD mission areas, as well as the military operations and force structures they imply. Finally, we propose a number of “mission success metrics” for each of these areas, even as we develop the WMD-E mission area further because the Army seems most likely to make its greatest contribution in this area.

Counter-WMD Operations and Challenges in Iraq

U.S. forces were ordered to conduct counter-WMD operations during both Operation Desert Storm (ODS) and OIF. The challenges of countering Iraqi WMD in the two decades up to and including OIF provide important insights for potential future operations—even though Iraq no longer had an active WMD program at the time of the invasion.¹ In this section of the chapter, we describe the various types of counter-

¹ The evolution of assessments of Iraq’s effort to develop WMD is described in the following reports: U.S. Central Intelligence Agency, *Iraq’s Weapons of Mass Destruction Programs*, Washington, D.C., October 2002; Kenneth Katzman, *Iraq: Weapons Threat, Compliance, Sanctions, and U.S. Policy*, Congressional Research Service, IB92117, updated November 19, 2002; David Kay, “Statement by David Kay on the Interim Progress Report on the Activities of the Iraq Survey Group (ISG) Before the House Permanent Select Committee on Intelligence, the House Committee on Appropriations, Subcommittee on Defense, and the Senate Select Committee on Intelligence,” October 2, 2003; Brigadier General Joseph J. McMenamain, Commander, Iraq Survey Group (ISG), *Statement for the Record*, October 2004; Iraq Survey Group, *Interim Progress Report*, Washington, D.C., October 6, 2004; Sharon A. Squassoni, *Iraq: U.N. Inspections for Weapons of Mass Destruction*, Washington, D.C., Congressional Research Service, RL31671, updated October 7, 2003; Special Advisor to the Director of Central Intelligence on Iraq’s Weapons of Mass Destruction, *Comprehensive Report of the Special Advisor to the DCI on Iraq’s*

WMD operations, along with some of the challenges faced during OIF and at other times in Iraq.

WMD Active and Passive Defense. During the major combat operations phase of OIF (i.e., OIF 1), the 32nd Army Air and Missile Defense Command (AAMDC) was assigned the operational protection mission—including warning of air and missile attack, active defense against theater ballistic missiles, and mitigating the effects of attack with chemical and other agents. This was a major undertaking that involved 7,200 air defense, chemical, military police (MP), and other soldiers deployed to eight countries.² Over the course of the major combat operations phase of OIF, coalition air defense units intercepted and destroyed all nine tactical ballistic missiles launched within their range fans, including several targeting command headquarters. However, several Iraqi cruise missiles managed to reach their targets, suggesting that challenges are likely to continue in the future.

WMD Interdiction Operations. These may be thought of as a particularly important case of preventing, preempting, defeating, or neutralizing terrorist, criminal, and covert activities. From August 1990 until OIF in March 2003, Iraq remained under a near-total United Nations (UN) Security Council–mandated financial and trade embargo. Following UN Security Council Resolution 665, which authorized a naval blockade of Iraq, a U.S.-led Multinational Interception Force was organized to inspect and, if necessary, impound vessels, cargoes, and crews suspected of violating the UN embargo of Iraq, including carrying weapons and other military equipment. Following ODS in 1991, UN Security Council Resolution 687 linked the embargo to Iraq’s dismantlement of its WMD program, as well as to preventing reconstitution of the program. The embargo remained in force throughout OIF.

WMD Offensive Operations. During OIF, one of the U.S. objectives was to “destroy Iraqi WMD capability and infrastructure.” The Combined Forces Air Component Commander (CFACC) accordingly apportioned more than 10 percent of the combat air sorties to suppressing “Iraqi TMD/WMD delivery systems” and “neutralizing/controlling WMD infrastructure and sensitive site exploitation.”³ An average of 72 coalition aircraft fighter sorties per day were apportioned for these targets. Over the course of the air campaign, they struck 832 “desired mean points of impact” (DMPIs) in support of suppressing WMD delivery systems, and they executed

WMD, with Addendums (the Duelfer Report), Washington, D.C., April 25, 2005; Iraq Study Group, *The Iraq Study Group Report*, New York: Vintage Books, 2006; and UNMOVIC, 2007.

² 32d AAMDC, *Operation Iraqi Freedom Theater Air and Missile Defense History*, Fort Bliss, Texas, September 2003.

³ T. Michael Mosely, Lieutenant General, USAF, Commander, U.S. Central Air Forces and CFACC, *Operation Iraqi Freedom—By the Numbers*, Assessment and Analysis Division, April 30, 2003.

102 missions against WMD as time-sensitive targets (TSTs).⁴ Special operations forces were also employed in western Iraq to hunt for Scud missiles.⁵

Some successes were reported during OIF in destroying transporter-erector-launchers (TELs) before they could launch their missiles. Three were destroyed by airstrikes on February 13, before war was declared, as they moved south of the 32nd parallel (and so became legitimate targets within the no-fly zone). Three others were reported as destroyed during combat operations by Predators on Iraq's Route 6—one with a missile still on board and the other two post-launch.⁶ These successes represent some improvement over counter-TEL operations in ODS—which had no confirmed destructions despite the coalition investing nearly 2,500 air sorties in the “Scud hunt.”⁷ But the continuing challenges of such operations was recently underscored by General Martin Dempsey, Chairman of the Joint Chiefs of Staff, when he stated that “the act of preventing the use of chemical weapons would be almost unachievable . . . you would have to have such clarity of intelligence . . . persistent surveillance, you'd have to actually see it before it happened and that's unlikely, to be sure.”⁸

WMD-Elimination Operations. The United Nations Special Commission (UNSCOM), the International Atomic Energy Agency's (IAEA's) Iraq Nuclear Verification Office (INVO), and UNMOVIC all were charged with inspection operations in Iraq prior to OIF. The ISG and the 75th Exploitation Task Force (75th XTF), and four Mobile Exploitation Teams (METs),⁹ had the responsibility for inspections in OIF. The scale of these efforts is highly suggestive of the sorts of challenges that may be encountered in the future when addressing large, clandestine, WMD development programs is required.

Between May 1991 and October 1998, UNSCOM and the IAEA Action Team on Iraq conducted several thousand inspections at more than 1,000 facilities,¹⁰ and they supervised destruction of more than 40,000 chemical munitions, nearly 500,000 liters of CW agents, 1.8 million liters of chemical precursors, and seven types of delivery

⁴ By comparison, the air campaign struck a total of 19,898 DMPIs and executed four missions against terrorists, and 50 against Iraqi leadership as TSTs.

⁵ COL Gregory Fontenot, U.S. Army, Retired; LTC E.J. Degen, U.S. Army; and LTC Dave Tohn, U.S. Army, *On Point—The United States Army in Operation Iraqi Freedom*, Operation Iraqi Freedom Study Group, Office of the Chief of Staff, U.S. Army, Washington, D.C., 2004.

⁶ 32nd AAMDC, 2003.

⁷ James Winnefeld, Preston Niblack, and Dana J. Johnson, *A League of Airmen: U.S. Air Power in the Gulf War*, Santa Monica, Calif.: RAND Corporation, MR-343-AF, 1994.

⁸ Lolita C. Baldor, “U.S. Troops Could Help Secure Syrian Weapons,” Associated Press, January 10, 2013.

⁹ Judith Miller, “After the War: Unconventional Arms; A Chronicle of Confusion in the U.S. Hunt for Hussein's Chemical and Germ Weapons,” *New York Times*, July 20, 2003.

¹⁰ Katzman, 2002, p. 4.

systems.¹¹ From November 2002 to early 2003, the IAEA's INVO and UNMOVIC conducted more than 750 inspections at 550 sites.¹² During OIF, an initial set of 578 "suspect sites" were identified, and two ad hoc organizations were hastily assembled for the WMD-E mission during the first months of OIF: the 75th XTF and the ISG.¹³

The 75th XTF consisted of about 900 personnel, including a 25-person MET Alpha forward.¹⁴ By early May 2003, the press reported that the 75th XTF had completed searches of 19 of 21 top weapons sites, and 45 of 68 top "non-WMD" sites, while DoD reported that a total of 70 out of roughly 600 potential weapons facilities had been searched.¹⁵ The MET Alpha reportedly had searched a total of 350 suspect sites by July 2003.¹⁶

The ISG had somewhere between 1,400 and 1,750 personnel who also were charged with inspecting suspect Iraqi WMD sites.¹⁷ Testimony by the ISG's commander in October 2004 revealed that in the preceding months the ISG had executed 2,700 missions, visited 1,200 different WMD sites (some more than once), published 4,000 Intelligence Information Reports, conducted 4,100 debriefings, scanned and processed more than 40 million pages of documents, processed 28,000 digital media sources, and processed more than 4 million analog media sources.¹⁸

The ultimate effectiveness of the 75th XTF and ISG was severely limited by several factors:¹⁹

1. The 75th XTF and ISG were both "pick-up teams"—organized and deployed very late in the run-up to OIF and without established doctrine, organization, and training. Hence, their TTP had to be made up "on the fly."
2. They were too small for the scale of their mission: The 75th XTF included 900 personnel and the ISG had 1,400–1,750; each had the mission of investigating

¹¹ CIA, 2002, p. 10. It is interesting to note that all of these munitions, bulk chemicals, and delivery systems escaped destruction during the extensive ODS air campaign.

¹² Squassoni, 2003.

¹³ See Raymond T. Van Pelt and Jim Currie, *JTF-WMD Elimination: An Operational Architecture for Future Contingencies*, Fort McNair, Washington, D.C.: Industrial College of the Armed Forces, National Defense University, April 28, 2004

¹⁴ See Miller, 2003; Barton Gellman, "Frustrated, U.S. Arms Team to Leave Iraq," *Washington Post*, May 11, 2003; and Alec Russell, "Disillusioned Inspector Quits Iraq Arms Hunt," *The Telegraph*, January 24, 2004.

¹⁵ Gellman, 2003.

¹⁶ Miller, 2003.

¹⁷ See Miller, 2003; Gellman, 2003; and Russell, 2004.

¹⁸ McMenamain, 2004, p. 4.

¹⁹ See Van Pelt and Currie, 2004; Rebecca K. C. Hersman, *Eliminating Adversary Weapons of Mass Destruction: What's at Stake*, Center for the Study of Weapons of Mass Destruction, National Defense University Press, Washington, D.C., December 2004.

hundreds of suspect sites. This made it impossible for them to secure and exploit multiple sites in parallel.

3. Their effectiveness was limited by the lack of an integrated WMD-E line of effort planned, directed, resourced, and coordinated by the joint commander.
4. Both of these organizations had limited ISR, transportation, and security assets either organic to them or on call from supporting forces. Therefore, they could not secure the most important sites—especially during major combat operations. As a result, the WMD-E-oriented units deployed to Iraq could not prevent some important sites from being looted.

The conditions for the WMD-E mission in Iraq were favorable when most of this work was done in 2003 and early 2004. After the invasion and for most of the first year, security in Iraq was relatively good, with the exception of a few problem areas.²⁰ There were no significant, organized military or paramilitary forces in the field to contest the WMD-E mission, nor were such forces competing with coalition forces to find and take possession of WMD weapons or facilities. For example, the WMD-E TFs sent out to find and secure WMD did not expect to find large military formations defending them or contesting routes along the way. Yet, even given these favorable conditions, in which WMD-E specialty forces were able to act with a high degree of freedom, the task exceeded the capacity of those units created to deal with it. Furthermore, because of the favorable security situation provided by some 150,000 coalition personnel and the lack of WMD to be found, the WMD-E operations in Iraq put no significant demand on security and logistical assets following the completion of combat operations.²¹

Counter-WMD in Future Operations

Syria

Although the Assad regime ultimately acceded to international demands that it dismantle its CW program, recent events in Syria raised the possibility that the United States and its allies could have faced the mission of eliminating Syrian CWs by force in the midst of a civil war. If Syria has, in fact, given up its CWs entirely, then this threat may end—as will be discussed in Chapter Four. However, much hard work remains before the world can, with reasonable confidence, determine that the Assad regime has

²⁰ The violent insurgent activity that most associate with Iraq did not commence at any scale until April 2004, and did not occur persistently until 2006. During 2003 and 2004, it was common for coalition military and civilian personnel to travel throughout the country in single or small numbers of unarmored vehicles with few personnel.

²¹ As noted above, neither the 75th XTF nor the ISG were organized or equipped to operate independently; they were embedded in a much larger joint operation of approximately 150,000 personnel that provided substantial area security, logistics, and other capabilities. In Appendix D, we provide a review of available estimates of the ratio of supporting troops to mission troops in Iraq.

not reneged on this agreement and that the danger of further Syrian use or proliferation of CWs has passed.

North Korea

North Korea presents an even more worrisome threat—it, too, houses an extensive CW program, but it has also detonated at least two functioning nuclear devices.²² In addition to threatening South Korea with a massive conventional or chemical artillery barrage, it may soon be able to threaten South Korea and Japan with nuclear weapons delivered by aircraft or missiles.²³ If North Korea collapses, these nuclear weapons would pose a grave threat to nations around the world, especially if they were to fall into the hands of violent extremists.

For example, consider the potential casualties that North Korea could inflict upon South Korea, Japan, or other western cities as outlined in Table 3.1.

As tragically demonstrated in Syria, CWs have the potential to inflict hundreds of casualties in a single attack. North Korea could almost certainly inflict tens of thou-

Table 3.1
High-Priority Threats and Potential Casualties (North Korean Example)

Weapon Type	Delivery Means (notional)	Potential Targets (notional)	Potential Casualties
Chemical	Artillery, aircraft, theater ballistic missile (TBM)	Republic of Korea (RoK) and Japanese populations	Tens of thousands
Biological	Aircraft, SOF, refugees	RoK and worldwide populations	Some risk of epidemic
Nuclear	Aircraft, TBM, SOF, terror groups	RoK and worldwide populations	Hundreds of thousands

²² Jonathan Medalia, *North Korea's 2009 Nuclear Test: Containment, Monitoring, Implications*, Congressional Research Service, November 24, 2010. The first test, in October 2006, was initially judged by the Office of the Director of National Intelligence (ODNI) to have been less than a kiloton, but later was assessed to have been a failure. The second test, in May 2009, was judged by ODNI to be “a few kilotons.” ODNI assessed the third test as follows: “The U.S. Intelligence Community assesses that North Korea probably conducted an underground nuclear explosion in the vicinity of P’unggye on February 12, 2013. The explosion yield was approximately several kilotons. Analysis of the event continues.” ODNI, “Statement by the Office of the Director of National Intelligence on North Korea’s Declared Nuclear Test on February 12, 2013,” February 12, 2013.

²³ Office of the Secretary of Defense, *Military and Security Developments Involving the Democratic People’s Republic of Korea 2012: A Report to Congress Pursuant to the National Defense Authorization Act for Fiscal Year 2012*, Washington, D.C., February 15, 2013:

North Korea followed its February 12, 2013, nuclear test with a campaign of media releases and authoritative public announcements reaffirming its need to counter perceived U.S. “hostility” with nuclear-armed ICBMs. North Korea will move closer to this goal, as well as increase the threat it poses to U.S. forces and allies in the region, if it continues testing and devoting scarce regime resources to these programs. The pace of its progress will depend, in part, on how many resources it can dedicate to these efforts and how often it conducts tests.

sands of casualties with its CWs—given the large number of artillery pieces in its possession that are within range of South Korea.²⁴

The effects of biological weapons are less clear. On the one hand, known agents can cause grave illness within affected populations.²⁵ On the other hand, it is difficult to predict with precision how effective the weapon delivery systems will be—or how broadly humans can spread infectious diseases.

Nuclear weapons have demonstrated the ability to inflict massive casualties with a single weapon.²⁶ The 16-kiloton weapon dropped on Hiroshima caused 90,000 to 140,000 deaths and destroyed four square miles of the city.²⁷ Hiroshima featured relatively low population density compared to most modern cities; smaller nuclear weapons detonated in a dense urban environment today might cause similar levels of casualties. A nuclear weapon can therefore cause more immediate destruction—by several orders of magnitude—than either chemical or biological weapons.

North Korea might be able to insert nuclear weapons covertly with SOF into target cities. Violent extremist groups stealing or purchasing nuclear weapons could pose a similar—if not directly state-supported—threat. Other nations, too, may acquire nuclear weapons and thus become potential threats, whether for ultimate use or further proliferation.

Potential Adversary Actions

As the effort to eliminate a collapsing nation's WMD plays out, it could involve a particularly high-risk “window” for WMD use or proliferation. That is, in the last months or days of a dying regime, fraught leaders might use WMD to strike either rebellious factions within their nation or real or perceived enemies on their borders. At the same time, some elements having control of—or access to—the regime's WMD might seek

²⁴ DoD, *2000 Report to Congress Military Situation on the Korean Peninsula*, September 12, 2000. “North Korea fields an artillery force of over 12,000 self-propelled and towed weapon systems. Without moving any artillery pieces, the North could sustain up to 500,000 rounds an hour against Combined Forces Command defenses for several hours. The artillery force includes 500 long-range systems deployed over the past decade. The proximity of these long-range systems to the demilitarized zone (DMZ) threatens all of Seoul with devastating attacks.”

²⁵ See U.S. Department of Homeland Security, *Biological Attack: What It Is*, web page, undated.

²⁶ See U.S. Department of Homeland Security, *Nuclear Attack: Supporting Exhibits*, web page, undated:

Table 1. Range in miles for Significant Events*

Yield (KT)	Shock Wave	Heat	Initial Radiation	Fallout Radiation (Downwind)
1	0.2	0.4	0.5	up to 3.4
10	0.4	1.1	0.8	up to 6.0

*Significant effects are 50-percent mortality from shockwave, heat, or a radiation dose of 400 rads.”

²⁷ See National Academies and U.S. Department of Homeland Security, “News & Terrorism: Communicating in a Crisis,” fact sheet, 2005.

opportunities to sell them to other states or extremist groups willing and able to buy. This places the United States and its allies on the horns of a dilemma: Enter too early, and risk precipitating a military strike from the dying regime—perhaps including the use of WMD; enter too late, and risk the proliferation of WMD to other dangerous states or extremist groups.

As an example, consider the adverse actions that a North Korean regime could take in its final days. Such actions could range from a spasmodic strike against South Korea or Japan to wholesale efforts to disperse and hide nuclear weapons and materials. Each of these actions could, by themselves, have severe consequences for the United States and its allies. Therefore, U.S. and coalition counter-WMD operations would need to be broad, as well as capable of executing several missions simultaneously, as shown in Figure 3.1.²⁸

Hostile former regime members might attack coalition forces entering a collapsing state that has WMD. At the same time, “entrepreneurial” former regime officials might move and hide WMD, components, and materials for later sale or to extort money from those nations most worried about WMD-armed terrorists. If they have enough time, these same elements could dismantle and hide critical equipment, such as centrifuges, for sale to other nations. It may be that these groups attempt to “wait out” the coalition—by

Figure 3.1
Counter-WMD Missions, Key Tasks, Notional Adverse Actions, and Risk “Windows”

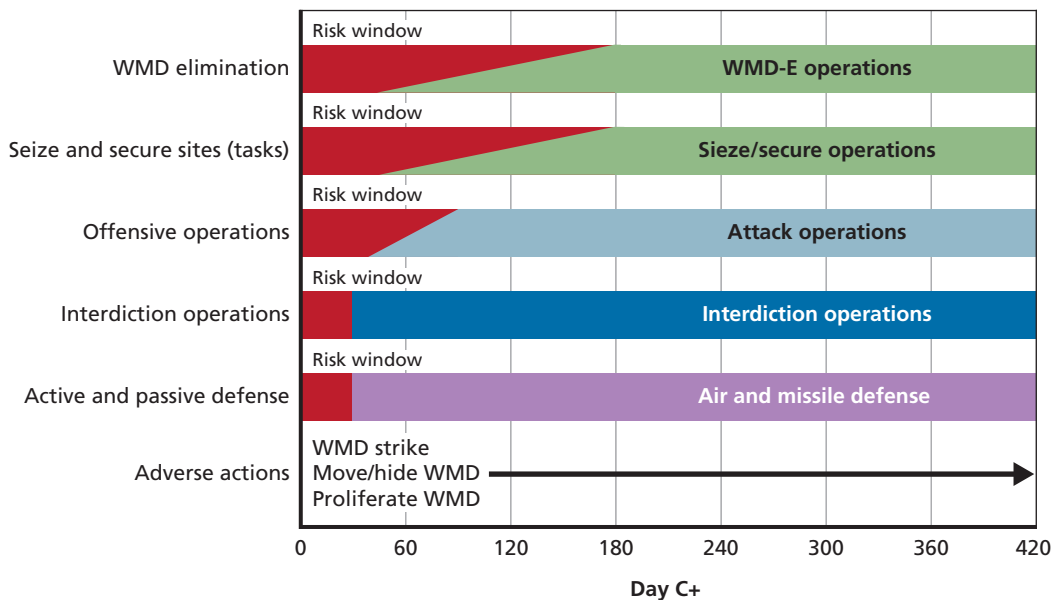

RAND RR541-3.1

²⁸ “Coalition forces” could include those of the United States, South Korea, international partners under the UN flag, and China.

keeping weapons, components, and equipment in hiding until coalition members withdraw. Once interdiction operations have diminished or ceased altogether, it may be easier or more likely for entrepreneurial proliferation attempts to succeed.

The Time Imperative

The geographic reach of WMD and their potential for catastrophic casualties place a priority upon the capability to counter and secure them before they can be stolen or used. A key factor for coalition operations and the actions of potential adversaries is time. One of the first military actions associated with WMD-E is to contain the problem and not let it grow with time. That means using all available tools to keep WMD from moving around in country or leaving the country by air, ground, or sea transport. This probably requires the full suite of overhead ISR assets, as well as troops on the ground and ships at sea, which cannot and should not strike every suspicious conveyance but may need to stop (or board) and search all of them. Stopping the use, even the launching, of WMD may be a higher priority than search and seizure, but both sets of tasks need to be performed simultaneously and quickly. This means that fire support, for example, cannot be limited to a counter-battery role following the launch of WMD but can and should also include prelaunch destruction of WMD threats—a highly time-sensitive task.

The window for seizing WMD, materials, technologies, and scientific and technical personnel before they can be dispersed or proliferated may be quite short. The buildup of forces to enter a country and conduct WMD-E and other operations could take weeks or months, but a ruling regime could collapse very quickly. WMD might then become much more vulnerable to theft and proliferation—e.g., if former commanders decide to sell or give them to SOF, terrorists, or others.

In some cases, we may be able to freeze the current situation, gain the time we need, preposition or build up the force structure required, then use the time available to find, secure, and neutralize WMD. In other cases, which require us to move more quickly, it might make sense to have at least some forces already on alert, perhaps prepositioned, but above all ready to move without delay. Various implications of countering WMD-proliferation and use abound, in other words, clearly affecting both force capacity (size) and capability (structure), as well as the planning and resources associated with them, and sometimes pulling in different directions. Prudent planning, of course, takes into account and attempts to balance among the different possibilities—including the various risks—involved.

In any event, as soon as possible, coalition forces should seize and secure suspected WMD sites and begin WMD-E operations. For example, coalition forces would ideally begin such operations as soon as the North Korean regime falls. In theory, coalition partners could begin operations immediately if they have enough warning to deploy forces, sufficient will to initiate operations in an ambiguous environment, and cooperative South Korean hosts willing to accept the arrival of coalition forces early.

However, if coalition forces deploy after North Korea falls, it will take some time to begin each line of effort.

An example from ODS is instructive. To begin operations in Saudi Arabia, it took 30 days to deploy two aircraft carrier strike groups, 400 fighter aircraft, and the first two divisions.²⁹ Although this represents a remarkably short time to deploy such sizable forces (a testament to what is logistically possible with sufficient political will), it also leaves a 30-day “risk window”—i.e., the time available for opposing factions to remove weapons and fissionable materials from sites and hide them in pre-determined or ad hoc locations—before air and missile defense, interdiction, and other counter-WMD operations could begin in earnest.

Other factors could slow these timelines further. For example, coalition partners might decline an advance into North Korea until they determine that entering forces would not be subject to attack.³⁰ Or entering forces might encounter significant opposition, poor road conditions, mines and other obstacles, refugee flows, or other conditions that slows their advance. If expected opposition is light, airborne or airmobile forces could quickly seize the most worrisome sites. However, if significant opposition is expected or encountered, it may be necessary to advance on some of these sites with heavier ground forces.

Together these factors could add weeks or even months to the time needed to seize, secure, and begin to eliminate WMD at key sites. This increases the “risk window.” Even after a significant delay, it remains important to seize, secure, and exploit known and suspected WMD sites: to eliminate weapons and materials remaining there, to rule these sites out as having had weapons, or to begin the process of locating and recovering weapons that have been looted and may be hidden nearby.

Counter-WMD Missions, Operations, and Forces

In addition to the imperatives of time and the risk windows that these imperatives dictate, Figure 3.1 suggests that, for *active* and *passive defense* missions, U.S. and coalition operations need to employ forces (as quickly as possible, to be sure) that are trained and ready to attack hostile forces and systems capable of employing WMD, as well as aircraft and missiles in flight. Human and technical intelligence assets, therefore, must maintain surveillance of hostile artillery and ballistic missile units, watching for signs of preparations to receive or employ WMD.³¹ As with offensive operations (described later), air, naval, ground, and special operations forces will be needed to pre-

²⁹ Winnefeld, Niblack, and Johnson, 1994; U.S. Army Center of Military History, *XVIII Airborne Corps in Operations DESERT SHIELD and DESERT STORM: An Annotated Chronology*, Historical Resources Branch, updated April 1998.

³⁰ As one official put it, “when they will be met with ‘minimal antipathy.’”

³¹ Human intelligence teams should focus on developing a more accurate understanding of DPRK WMD programs, but also will be needed to gather information regarding the degree to which critical portions of the nation’s infrastructure, government, and military are still functioning.

empt the use of nuclear, chemical, and biological weapons against U.S. and coalition operations.³² During Operation Southern Watch in Iraq, the U.S. Army maintained 400 soldiers in Saudi Arabia and Kuwait manning Patriot missile systems for this purpose. During OIF, air- and missile-defense operations grew to more than 7,200 soldiers manning more than 30 missile batteries and providing additional capabilities for chemical, biological, radiological, and nuclear (CBRN) mitigation.

WMD *interdiction operations* would include stopping and inspecting ships and aircraft (upon landing) that leave North Korea to thwart attempts at smuggling out WMD and components on a timely basis. For example, if China sets up a buffer zone following a North Korean collapse, U.S. and other coalition forces could set up checkpoints south of such a zone or other areas under Chinese control and could alert Chinese forces to interdict WMD smuggling operations across their land border with North Korea. U.S. and coalition operations associated with this mission area would require that national and tactical intelligence capabilities, air and naval forces, and SOF play key roles.

WMD *offensive operations* would seek to disrupt, neutralize, or destroy a WMD threat before it can be carried out or to deter subsequent use of such weapons. Coalition forces would need to be ready to conduct attack operations with air and special operations forces to seize WMD deployed with ground, aircraft, and missile units. Immediate action will be required if former regime forces prepare to launch air or missile attacks. WMD offensive operations would be a second key mission for intelligence, SOF, and ground and air strike capabilities.³³

The mission area of *WMD-E* potentially requires larger joint and multinational forces for its operations than any of the other mission areas. In part, that is because this mission area also involves a distinctive set of closely linked tasks that enable the mission—namely, the need to *seize and secure sites* suspected of harboring WMD. That is why these tasks are listed immediately below WMD-E in Figure 3.1. Maneuver forces from the larger joint force help clear the way for WMD-E TFs by isolating, seizing, and perhaps assaulting WMD facilities, while the WMD-E TFs search and clear the facility, exploit the site and render it safe, and (in some cases) remove the WMD.³⁴ Should former regime or insurgent forces oppose these operations, WMD-E forces need to have enough organic capability to defend themselves; hence, the larger joint force will have to assign it adequate combat capabilities to neutralize opposing forces and provide wide-area security for WMD-E TFs and their Lines of Communication

³² During OIF, 70 aircraft sorties/day were allocated for this mission.

³³ Care would need to be taken in the employment of strike assets, because if strikes are not well planned, they could rubble WMD sites, making it harder to examine, render safe, and evacuate.

³⁴ We assume that in most cases, joint forces encountering weapons caches would post security details to secure them and then move on, but that in some cases, they might call upon the force commander to provide a suitably sized WMD-E task to provide assistance.

(LOC). Put another way, WMD-E TFs would largely be operating in concert with and under the protection of maneuver forces that are part of the larger joint or combined force. U.S. forces would also be responsible for consequence management wherever U.S. forces were engaged, and they might also provide assistance to coalition and civilian authorities if WMD were employed against them.³⁵

U.S. and coalition forces could also be assigned to seize and secure potential WMD sites for later exploitation. This may be especially useful when a given site is vulnerable to looting but the available WMD-E TFs are all engaged at higher priority sites. Available combat teams would then be assigned to seize critical vulnerable sites and hold them until a WMD-E TF arrives.

Because operations involved in performing the WMD-E mission, as well as the seize-and-secure tasks associated with it, require a relatively greater use of ground forces than the other missions discussed, we have chosen to focus on this mission and its associated operations in the remainder of this chapter and in the next one. Our analysis of countering WMD, as the title of this document indicates, addresses the question of what the U.S. Army can contribute to such an overarching national security strategic priority. It makes sense, therefore, to concentrate our further efforts here on a mission area—WMD-E—in which the Army seems more likely to play a leading role than in other areas where, as the previous discussion suggests, other services may take the lead.

That is one main reason for focusing the rest of this report on the WMD-E mission. There is also another such reason, however, noted on page 1 of this report: that elimination of highly threatening WMD is, in a real sense, the ultimate mission, the one served by all the other WMD mission areas discussed in this document—active and passive defenses, interdiction, offensive operations, and quick action to seize and secure suspected sites—and against which, in effect, they are all assessed, at least to some degree. In the end, getting these most-dangerous weapons out of the hands of highly threatening states and people—and keeping them out of their hands by getting rid of them—is what all of these missions are all about. It is what countering WMD is all about.

Other services seem likely to play key roles in the other mission areas listed in Figure 3.1. The U.S. Air Force and Navy, for example, might be expected to take the lead in and contribute relatively more forces to the “interdiction” mission area. These services might also play significant roles in the WMD-E mission area, as integral parts of a joint effort. Notwithstanding a JTF’s joint composition, however, when it enters into the WMD-E mission area, it is likely to assign the bulk of its roles and missions to ground forces—in particular, troops in the U.S. Army that are specially trained and ready to perform WMD-E tasks.

³⁵ For example, the 20th Support Command might provide its CARA, C2 for WMD-Coordination Elements, and the USAR Consequence Management Unit, which is under its operational control, as well as decontamination units.

Notional Counter-WMD Operations in Failed States

In this report, we do not intend to predict the operational environment that commanders will face, the objectives they will be assigned, or the ways in which they will design campaigns to achieve these objectives. Each of these items will depend upon how each situation evolves, the context of each mission, the forces available, and the priority objectives (as well as the risks) accepted by the National Command Authorities (from the President on down). Instead of making risky (and—in the event—almost certainly erroneous) projections, we will provide a parametric analysis that covers a range of objectives, missions, and campaign designs as described later. Recall again that, for reasons explained in the preceding paragraph, our ultimate focus in this analysis is on the WMD-E mission area and the Army's role in operations intended to accomplish that mission—i.e., what it can contribute as a service and how many of its forces seem likely to be required. Hence, the WMD-E mission area is featured throughout the remainder of this chapter.

Operational Environments

The threat level in the operational environment is a key factor in estimating WMD-E conventional ground force requirements. The threat level may differ across sites—e.g., insurgents or regular enemy combat units may be operating in the area of some WMD sites, or adversaries may defend key WMD sites with substantial forces. Therefore, security forces to protect the WMD-E TFs need to be tailored to the local operating environment.

Doctrinally speaking, an operational environment is defined as a “composite of the conditions, circumstances, and influences that affect the employment of capabilities and bear on the decisions of the commander.”³⁶ WMD-E operations may be conducted in uncertain or hostile operational environments requiring substantial security or maneuver forces to address threat capabilities.³⁷ In our analyses, then, we consider four classes of operational environment that differ in their threat level: (1) Uncertain; (2) Uncertain/High Threat; (3) Hostile; and (4) Hostile/High Threat. We define these environments as follows:

- An *Uncertain environment* is defined as an “operational environment in which host government forces, whether opposed to or receptive to operations that a unit intends to conduct, do not have totally effective control of the territory and

³⁶ DoD, *Department of Defense Dictionary of Military and Associated Terms*, Washington, D.C., JP 1-02, May 2011b; and DoD, *Operations*, Washington, D.C., JP 3-0, August 2011c.

³⁷ DoD, 2009, p. IV-2. According to ATTP 3-11.23 (pp. 1–2), WMD-E operations are not envisioned to be conducted in permissive environments. DoD defines a permissive environment as an “[o]perational environment in which host country military and law enforcement agencies have control as well as the intent and capability to assist operations that a unit intends to conduct.” WMD-E operations in Iraq between 1991 and 1998 would seem to be a good example.

population in the intended operational area.”³⁸ We believe that this is a best (but not most-likely) case after a state collapse. For purposes of our analysis, we distinguished between two threat levels:

- *WMD-E (Uncertain)*. This operating environment poses a low risk to U.S. operations, involving irregular forces operating independently and occasionally attacking when they seek some direct benefit. WMD-E TFs can enter WMD sites without a combat assault, and they can operate with acceptable risk relying upon their organic maneuver units.
- *WMD-E (Uncertain/High Threat)*. This environment imposes a higher risk of opposition, with irregular (and perhaps some regular) forces capable of conducting frequent, coordinated attacks against U.S. and coalition forces. WMD-E units will need to assault sites and clear them of irregular forces; thus they will need additional maneuver units assigned to them for force protection.
- A *Hostile environment* is defined as an “operational environment in which hostile forces have control as well as the intent and capability to effectively oppose or react to the operations a unit intends to conduct.”³⁹ We think that this is the most likely environment U.S. forces would face during a civil war, or when significant portions of a regime’s military remain intact—say, in the initial stage of a DPRK collapse, or perhaps for a prolonged period after the conclusion of major combat operations in the event of a war between North and South Korea. We similarly distinguished between two threat levels for modeling purposes:
 - *WMD-E (Hostile)*. This environment poses a significant threat of organized opposition from surviving conventional units up to brigade strength in some cases. The JTF commander will have to direct the maneuver units to provide wide-area security, secure LOC, and cooperate with WMD-E TFs in seizing and securing WMD sites.
 - *WMD-E (Hostile/High Threat)*. This environment essentially constitutes WMD-E in the presence of an adversary with a functioning military. The JTF commander must clear avenues of advance for WMD-E TFs, as well as defend these areas against organized forces larger than brigades. Before exploitation, every site must be assaulted and cleared of defenders. WMD-E forces will remain under constant threat of attack, so maneuver forces must hold these sites during exploitation operations.

Campaign Objectives

Counter-WMD campaigns might be conducted as a part of much broader political-military campaigns in failed states—including efforts to protect neighboring nations,

³⁸ DoD, 2011b; DoD, 2011c.

³⁹ DoD, 2011b. As of the August 2011 edition of *Operations*, DoD no longer has a formal definition for a hostile environment. The definition provided here is the one used prior to August 2011.

provide humanitarian assistance, and stabilize and secure the population, as well as recovering WMD and related materials. We describe some of the objectives and missions that might be assigned to U.S. forces in Figure 3.2 and give some examples of the ground forces employed in recent campaigns.

The operations listed in Figure 3.2 are inherently joint and, thus, will necessitate a corresponding effort from air, land, sea, and special operations forces. Allies and coalition partners may also be available to substitute for some of the soldiers in future operations.⁴⁰ The overarching campaign would be under a joint and multinational force commander—as shown in the notional command structure in Figure 3.3.

The combined/joint commander would be responsible for accomplishing the overarching campaign objectives and would set the conditions for counter-WMD (including WMD-E) operations. Operations in a failed DPRK or the sorts of operations that might have been needed in Syria could also require forces to neutralize remaining military forces or insurgents. This will require a mix of combat and specialty forces over and above those needed for countering WMD in the failed state.

Implications for Force Capability Requirements

The coalition force capabilities needed to execute counter-WMD missions and tasks would be both broad in scope and potentially large in scale, as illustrated in Table 3.2. Air and missile defense will depend upon ISR capabilities to find, fix, track, and target hostile aircraft and missiles. SOF and other behind-the-lines ground forces may augment these systems by providing reconnaissance in each of the domains. Fighter aircraft and sea- and air-based defensive missiles will be needed to destroy threats before they can reach their targets. Attack aircraft and sea- and ground-based artillery and missiles would be needed to conduct counterbattery fires to destroy missile launchers after they have fired.

Similarly, air, sea, and ground forces would need to monitor the movement of vehicles and craft in each of their domains and be ready to interdict them when their movements or direction raise concerns that they may be moving WMD or related components. SOF must be ready to deploy through each domain to inspect suspicious cargoes and seize them as required.

Offensive operations depend upon the ISR capabilities needed to find WMD that are deployed to airfields or TBM garrisons, and SOF and conventional ground capabilities to seize these weapons before they can be used or moved. In addition, air and maritime forces may be employed to neutralize or destroy TBMs and other WMD employment systems; or to neutralize C2 and targeting systems.

⁴⁰ It is possible, for example, that Turkey and Jordan could have participated in WMD-E operations in Syria, and possibly other U.S. allies and friends as well. Building partner capacity for WMD-E operations could be useful in future planning.

Figure 3.2
Notional Campaign for Counter-WMD Missions

Notional campaign
Enter failed state and find, seize, and secure weapons of mass destruction, materials and components, personnel, and supporting facilities. ^a
Objectives and missions
<p>Establish U.S. forces in region to defend allies and prepare for future operations</p> <ul style="list-style-type: none"> • Establish operating bases and logistics nodes • Move forces into theater; prepare for and support operations <ul style="list-style-type: none"> – Example: 3rd Army in Kuwait—15,000 soldiers, 2008
<p>Enter failed state, secure logistics infrastructure, and counter hostile action</p> <ul style="list-style-type: none"> • Secure sea- and airports, major road and rail networks • Establish major operating bases and logistics centers • Identify and locate potentially hostile force concentrations • Neutralize forces that attack advancing U.S. and coalition forces • Conduct wide area security operations
<p>Counter the use, proliferation, or transfer of WMD from the failed state</p> <ul style="list-style-type: none"> • Conduct WMD active and passive defense <ul style="list-style-type: none"> – Conduct theater air and missile defense – Example: 32nd Army Air and Missile Defense Command (AAMDC) in Southwest Asia—7,200 soldiers, 2003 • Conduct WMD interdiction • Conduct WMD offensive operations <ul style="list-style-type: none"> – Mainly SOF and air-mobile quick response forces • Conduct WMD elimination <ul style="list-style-type: none"> – Seize and secure forces – WMD-E task forces – Our estimate: 106,000 soldiers for Syria, 188,000 soldiers for the DPRK • Conduct WMD mitigation <ul style="list-style-type: none"> – Example: JTF Protection, 2003
<p>Provide humanitarian assistance</p> <ul style="list-style-type: none"> • Example: CJTF-Haiti, Haiti Earthquake relief—20,000 soldiers, 2010^b
<p>Conduct security and stability operations</p> <ul style="list-style-type: none"> • Example: MNF-I, OIF—up to 180,000 troops, 2003–2011^c

^a Please see Appendix C for factors that would influence the design of a WMD-E campaign in the DPRK.

^b Under Secretary of Defense for Personnel and Readiness, *Defense Manpower Requirements Report, Fiscal Year 2012*, Total Force Planning and Requirements Office, April 2012.

^c Defense Manpower Data Center, Contingency Tracking System Deployment File, July 31, 2011.

Figure 3.3
Notional Combined/Joint Force Command Structure for Counter-WMD Missions

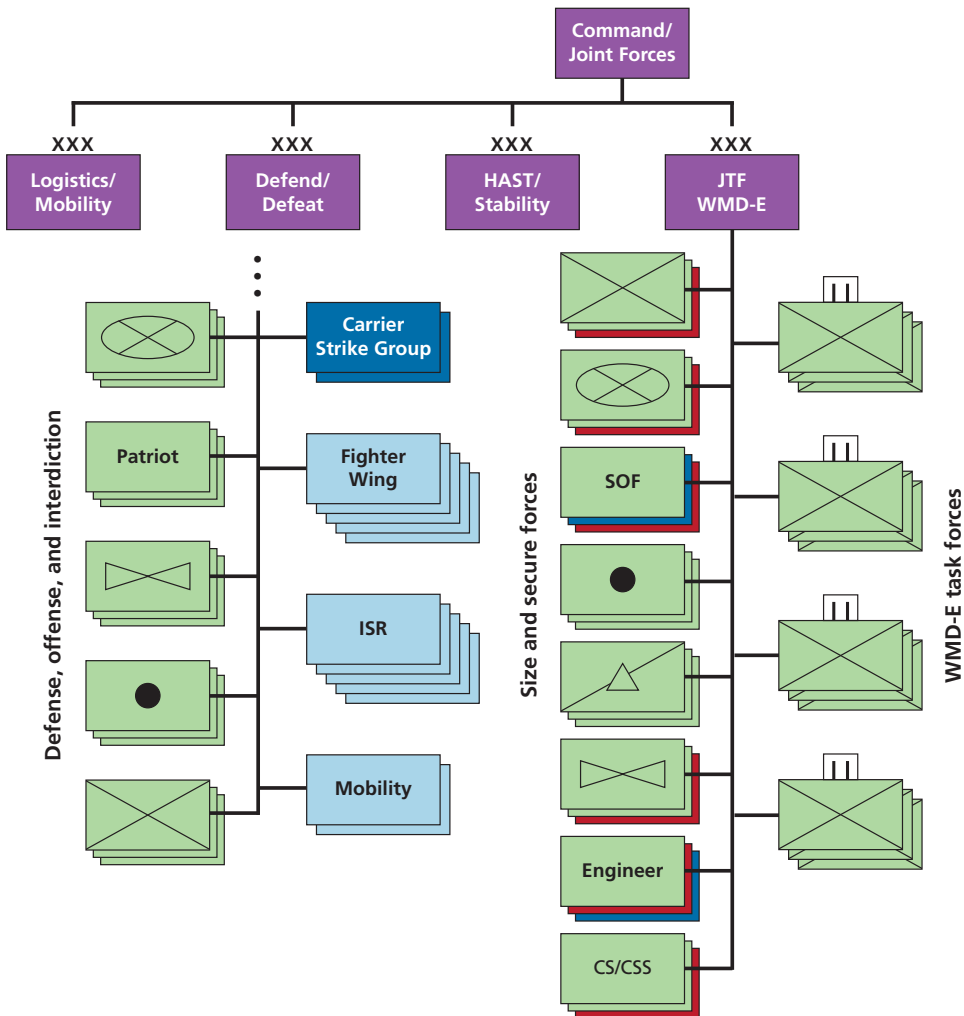

NOTE: HAST = Humanitarian Assistance Survey Team; CS = combat support; CSS = combat service support.

RAND RR541-3.3

Seizing and securing WMD-related sites, which are tasks associated with the WMD-E mission, help make this the largest of the mission areas in terms of scope and scale. As we will describe in Chapter Four, the number of sites that may need to be secured could range from ten to well over 100 scattered across an entire nation. The list may also grow over the course of the campaign as new intelligence is gathered or sites are encountered during ongoing operations. As mentioned before, regime remnants may decide to oppose operations to secure some or all of these sites—and, depending upon the operational context, that opposition might range from small groups of irregular

Table 3.2
Counter-WMD Missions, Key Tasks, and Exemplar Force Capability Requirements

Missions and Task	Force Capability Requirements			
	Air	Maritime	SOF	Ground
WMD elimination	<ul style="list-style-type: none"> • ISR • Ground attack • Air transport 	<ul style="list-style-type: none"> • Sea basing for ground and logistics ops 	<ul style="list-style-type: none"> • Quick response • Direct action • Reconnaissance 	<ul style="list-style-type: none"> • WMD-E task forces (TFs) • Area security • Logistics
Seize and secure sites (tasks)	<ul style="list-style-type: none"> • ISR • Ground attack • Air transport 	<ul style="list-style-type: none"> • Sea basing for ground and logistics ops 	<ul style="list-style-type: none"> • Quick response • Direct action • Reconnaissance 	<ul style="list-style-type: none"> • Combined-arms maneuver • Cordon and search
Offensive operations	<ul style="list-style-type: none"> • ISR • Ground attack • Counterstrike 	<ul style="list-style-type: none"> • ISR • Ground attack • Counterbattery 	<ul style="list-style-type: none"> • Quick response • Direct action • Reconnaissance 	<ul style="list-style-type: none"> • Quick response/direct action • Counterbattery
Interdiction operations	<ul style="list-style-type: none"> • ISR • Air/sea/ground interception 	<ul style="list-style-type: none"> • ISR • Sea interception 	<ul style="list-style-type: none"> • Quick response • Direct action • Reconnaissance 	<ul style="list-style-type: none"> • ISR • Ground interdiction
Air and missile defense	<ul style="list-style-type: none"> • ISR • Air defense • Ground attack 	<ul style="list-style-type: none"> • ISR • Missile defense • Counterbattery 	<ul style="list-style-type: none"> • Strategic reconnaissance 	<ul style="list-style-type: none"> • ISR • Missile defense • Counterbattery

forces to coherent military units operating at brigade level. Combined-arms maneuver forces will be needed to seize and secure sites against opposing forces hidden in buildings or prepared defensive positions, to provide wide area security around the sites, and to conduct and protect logistics operations. They will require the support of air forces for ISR, to deliver airborne forces, and to attack enemy forces that present themselves. Maritime forces might provide sea-basing for ground and logistics operations—and perhaps special operations. SOF might provide on-the-ground reconnaissance, as well as quick response to deal with sudden discoveries of WMD or other high-value targets.

Mission Success Metrics

The United States and its coalition partners will need to establish success metrics for each of the counter-WMD missions as shown in Table 3.3.⁴¹

For air and missile defense, a (negative) metric could simply be the percentage of air and missile strikes that penetrate coalition defenses, and the effects that those

⁴¹ The metrics presented in this table, which are based on numbers and kinds of actions taken, should not be confused with measures of effectiveness, which attempt to assess overall “outcomes” achieved by a particular mission—e.g., how many potential attacks were prevented or human lives saved by eliminating WMD. The metrics listed in Table 3.2 can be used to measure mission “outputs,” which are important precursors to mission success, but they do not measure success directly in terms of overall mission outcomes. For that, other measures, which lay beyond the scope of the work presented here, would need to be developed and employed.

Table 3.3
Counter-WMD Missions, Key Tasks, and Success Metrics

Mission Success Metrics	
WMD-E	<ul style="list-style-type: none"> • Percentage/number of weapons recovered • Percentage/amount of key materials recovered, destroyed, or rendered safe • Percentage/number of key industrial components recovered or destroyed • Percentage/number of personnel debriefed and documents recovered • Percentage/number of sites closed or consolidated
Seize and secure sites (tasks)	<ul style="list-style-type: none"> • Days needed after C-Day (the day upon which forces are committed to the operation) to secure WMD sites • Percentage of WMD sites identified, seized, and secured
Attack operations	<ul style="list-style-type: none"> • Number of WMD operations identified and weapons secured • Number of TBM operations identified and neutralized
Interdiction operations	<ul style="list-style-type: none"> • Percentage of aircraft spotted, forced to land, inspected • Percentage of maritime craft spotted, stopped, inspected • Percentage of ground vehicles spotted, stopped, inspected
Air and missile defense	<ul style="list-style-type: none"> • Percentage of air strikes intercepted • Percentage of missile strikes intercepted • Effects of missile and air strikes

strikes have on coalition forces and populations. The success of interdiction operations could be measured (positively) by the percentage of air- and maritime craft that are spotted, stopped, or forced to land (and/or followed to their landing point), and inspected. Similarly, the success of ground interdiction could be the percentage of trucks, train cars, and other vehicles stopped and inspected before they cross into China. If possible, it would be desirable to also interdict vehicles attempting to enter or exit suspected WMD sites.

Attack operations could be measured by their ability to identify and neutralize TBM operations before they launch; and by their ability to secure WMD that have been located with artillery, missile, or aircraft units. The tasks of seizing and securing sites would be measured by the number of days after C-Day by which they secure WMD sites, and the percentage of WMD sites that are identified, seized, and secured until they can be searched. Success in the WMD-E mission would depend upon several measures, including the percentage and number of weapons, fissionable materials (nuclear), key chemical or biological agents, and key industrial components (e.g., centrifuges for uranium enrichment) recovered. (The number of ballistic missile and launch vehicles could also be included as WMD-related systems.) In addition, the percentage and number of weapons and critical materials destroyed or rendered safe, key WMD program personnel debriefed and documents recovered, and sites closed or consolidated will all be important for ensuring that a complete picture of the WMD program has been established.

Culminating Counter-WMD Operations: The WMD-E Mission

WMD-E TF Design

The WMD-E mission requires tailored WMD-E TFs to isolate and exploit potential WMD production, storage, or research facilities while operating in an uncertain and potentially hostile situation. These TFs will be responsible for providing security within each site, cordoning off and conducting search operations within facilities, and finding, identifying, and securing or removing WMD, materials, and components. Current doctrine assumes that WMD-E TFs will be sized according to the security level of the environment in the immediate vicinity of a WMD site, as well as the size of the site: large, small, or very small, as shown in Table 3.4. The details of the WMD-E TFs are presented in Appendix E (not available to the general public because it contains analysis based on information with restricted distribution).

As can be seen, a large factory or test facility should be assigned a WMD-E TF built around a maneuver battalion. Large sites may occupy several square kilometers and comprise hundreds of buildings and bunkers. A smaller site—such as a cave complex or group of buildings—could be assigned a TF built around a maneuver company. A single building might be assigned a TF built around a single platoon.⁴² Operational planners would assess the size and composition of WMD-E TFs that would be needed for WMD-E operations at each prospective site in the WMD target list.⁴³ In all cases, planners would need to ensure that sufficient organic or assigned maneuver forces are available to provide sufficient security at each WMD site and to secure the LOC among them. These security forces could be in addition to the organic WMD-E TFs.

Table 3.4
Matching WMD-E TF and WMD Site Size

Size	Description	Task Force
Large	Factory complex or production and test facility (e.g. reprocessing facility with a collocated metal fabrication plant)	Battalion-sized (~1,064 personnel)
Small	Group of warehouses, a medium-sized cave, or a walled compound (e.g. plutonium production reactor)	Company-sized (~319 personnel)
Very Small	Single building (e.g., Tuwaitha yellow cake storage facility)	Platoon-sized (~108 personnel)

SOURCE: U.S. Army, 2011a, pp. 4–13, D-2.

⁴² U.S. Army, 2011a, pp. 4–13; U.S. Army, 2010d, p. A-10.

⁴³ Planners also might hedge by including consideration of WMD-E TFs that would not be assigned to a specific site but could be allocated to exploit sites that are discovered in the course of the operation.

Estimating the Duration of the WMD-E Mission

Beyond the basic force requirements of WMD-E operations, a key planning consideration is the potential duration of a WMD-E campaign. We conducted a first-order estimate of the duration of a WMD-E mission at a single site—from first entering a site up to completing search and exploitation operations at that site or transitioning to follow-on forces for further exploitation. The time each WMD-E TF spends on-site will determine the pace at which the TF can proceed to the next available site in a WMD target set, and, in the aggregate, will determine the duration of the WMD-E portion of the overall campaign.

The timeline for a WMD-E operation at a given site—securing, rendering safe, and removing or destroying WMD, materials, or technology, as well as securing WMD scientists and personnel who present a proliferation threat themselves—could be on the order of days to months, depending on the size and complexity of the site, the availability of specialists, whether weapons or materials have been removed (and the TF is ordered to track them down), and other factors. However, we thought it useful to make some estimate of how long it might take to clear a large WMD site in order to estimate the total amount of time required for a WMD-E campaign. To do so, we used the “average time” associated with WMD-E operations for an “average” large WMD site described in Table 3.5. We derived the site characteristics from information recorded concerning Tuwaitha and al-Muthanna, and relevant time factors from Army doctrine.⁴⁴

We estimate that it would take, on average, four days to seize and secure a site, three days to confirm or deny that the site was relevant to the country’s WMD pro-

Table 3.5
WMD-E Timelines for a “Typical”
Large WMD Site

Phase	Time
Isolation	
Seize and secure	4 days
Survey (confirm/deny)	3 days
Exploitation	18 days
Hand-off and onward movement	5 days
Total time	30 days

⁴⁴ Our more detailed analysis of this question is provided in Appendixes E and F. (These are not available to the general public because they contain analysis based on information with restricted distribution.) We note that the timelines in Table 3.5 are for a large and complex site like Tuwaitha or al-Muthanna—and Iraq had only a few such large facilities. It is possible that the bulk of a country’s facilities will require, on average, less time to handle than our estimates for Tuwaitha or al-Muthanna and that smaller facilities take even less time. There may also be very large facilities such as Yongbyon that could take several months to completely search and render safe.

gram, and 18 days to exploit the site. In addition, we estimate another five days for the TF to hand off operations to “follow-on forces,” reassemble their convoys, coordinate with maneuver forces securing the next site, and covering the roads leading to it, moving to the next site, and deploying to begin another exploitation mission.⁴⁵ As a result, we estimate the total average cycle time for a WMD-E TF at a typical large WMD site to be about 30 days.

We will use the timelines in Table 3.5 in the scenario analyses that follow in Chapter Four to estimate the total time needed to clear failed states of WMD at the highest priority sites.

Summary

The WMD-E mission is at the core of counter-WMD campaigns and the main focus of most of our analysis. Ground forces are especially well suited to performing this mission—the Army in particular—and they can best perform the mission within the context of a joint force dedicated to executing a counter-WMD campaign plan. Eliminating weapons of mass destruction—and the industrial-scale capabilities to build and maintain them—is a relatively new and very challenging mission area. Specially trained and organized WMD-E TFs need to be established and tasked to conduct the complex operations involved. These TFs will have to be multifunctional and combat-capable, since they are responsible for cordoning off and conducting search operations within site facilities, as well as for finding, identifying, and securing or removing WMD, materials, and components. WMD-E TFs must also be large and capable enough to provide their own security within the context of a broader joint campaign. Army forces are especially capable in this regard—quintessentially joint, and ultimately expandable, provided sufficient resources are provided to bring this military policy option into better alignment with national security strategy.

⁴⁵ While the composition and operational concepts for these follow-on forces are not considered in detail in this report, they would either need some ability to handle the WMD sites they are given responsibility for or to be in place until such capabilities were provided by the United States or a partner state.

Illustrative WMD-E Scenarios and Ground Force Requirements

The potential scope and scale of the WMD-E mission, as well as the challenges to accomplishing it that might be encountered, can be illustrated through scenario analysis. In this chapter, we describe two prospective cases of WMD-E operations that are of particular salience today: the collapse of the DPRK and the counterfactual case of the collapse of a CW-armed Syrian Arab Republic. In addition to representing two emergent real-world cases, these scenarios can provide important insights into potential WMD-E force requirements in other scenarios. We direct our efforts here to the WMD-E mission for several reasons: First, because we believe it to be the largest, most under-resourced, and least examined of the counter-WMD mission areas; second, because it involves the greatest potential requirement for ground forces; and third, because the Army—a principal focus of our attention in this report (i.e., how it can help)—is particularly well suited to meeting the expansive ground force requirements called for in this mission area.

We devote much less attention here to the other counter-WMD missions—e.g., active and passive defense, and consequence management. As discussed in Chapter Two, the other mission areas (*ways*) appear to be better understood and better resourced. Thus, we do not factor these areas, the forces they might require, or the forces required to achieve other potential campaign objectives discussed in Chapter Three (e.g., deter/defeat hostile forces, humanitarian assistance, stability operations) into our force requirements. If force requirements for these other missions and objectives were to be included, they would be additive to the ground force requirements that we estimate in this chapter.

This chapter applies the planning constructs described in Chapter Three to demonstrate the sensitivity of WMD-E force requirements to such scenario characteristics as the number of WMD sites that are to be targeted in an initial assault, the assumed level of threat in the operating environment, and the ratio of supporting forces to mission forces. It also provides a first-order analysis of the number of large WMD-E TFs that can be supported by currently planned Army force structure. We then turn to illustrative analyses of two notional scenarios based upon countries known to have, or that previously had, extensive WMD programs: the DPRK and the Syrian Arab Republic. These scenario-based analyses are intended to illustrate the ground force

requirements for WMD-E operations embedded in a notional joint campaign and to reinforce the importance of considering WMD-E forces in broader U.S. force and campaign planning.

General Case: Overview and Summary of WMD-E Force Requirements

A key consideration in sizing forces for WMD-E operations is to secure as many WMD sites concurrently as possible to prevent the most dangerous WMD from being proliferated or used. In cases such as those of the DPRK and Syria, the WMD-E mission may be one of the highest-priority missions in a larger joint or combined operation. Due to the high importance of this mission and the security challenges posed by the DPRK and Syria, WMD-E could become the JTF's core mission. In this section of the chapter, we summarize our estimates of the potential forces needed for WMD-E operations, and we sketch out some broader implications of WMD-E operations for force structure.

Figure 4.1 presents estimates of the number of brigade combat teams (BCTs) that would be required for WMD-E operations against different assumed numbers of WMD sites to be assaulted concurrently in initial operations, as well as different levels of threat in the operational environment.¹ We assume that these sites will each require a battalion-sized unit to secure them—either a maneuver battalion serving as a “front-end” force to seize and secure the site only, or a battalion-sized WMD-E TF to fully eliminate the site and its weapons. These battalions and their parent brigades would draw from armored, Stryker, infantry, and airborne or airmobile forces as needed to provide the mix of speed, mobility, protection, and lethality best suited to the campaign plan.

As might be expected, the conventional ground forces required for WMD-E operations scale with the number of sites to be assaulted in initial operations: this linear component is the result of adding battalion-sized WMD-E TFs, while the slight upward bow in each line is due to the addition of headquarters and related elements as the overall WMD-E force gets larger.²

There also are significant differences in the required force levels associated with the different operational environments: the Hostile/High Threat environment requires roughly four times the forces that the Uncertain environment does at each level of

¹ Our estimate is for battalion TFs—which could be broken down into company or platoon TFs. We assume that overall theater security and any combat operations involving regime remnants would be conducted by other joint or combined forces. The chart estimates BCT equivalents only; supporting forces are not included. See Appendix D for a review of available estimates of the ratio of supporting troops to mission troops in Iraq.

² The force sizing details are provided in the discussion of Tables 4.2 and 4.4.

Figure 4.1
Number of BCTs Required for WMD-E Operations at 5–50 Large WMD Sites

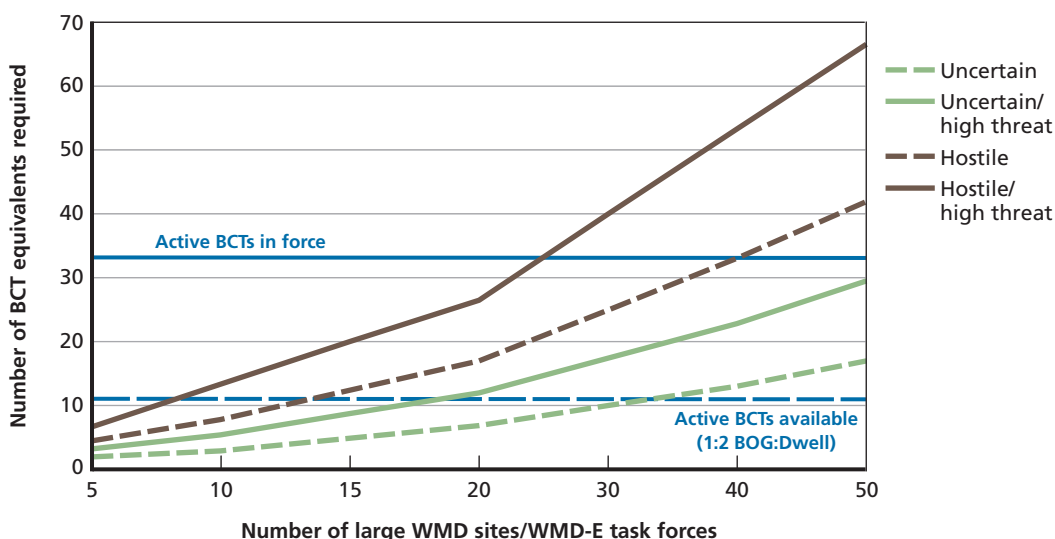

NOTE: The number of BCTs available is based on the assumption of 33 AC three-battalion BCTs in the force in fiscal year 2017.

RAND RR541-4.1

WMD sites. Thus, 15 large WMD sites are estimated to require 5–20 BCTs for WMD-E operations, depending on the operational environment.³

Figure 4.1 also notes the number of active component (AC) BCTs—33—that are expected to be in the force in fiscal year 2017,⁴ and the number that would be operationally available assuming a 1:2 boots-on-the-ground (BOG):Dwell ratio (11—one BCT forward, one preparing for deployment, and one in reset from a previous deployment). As can be seen in Figure 4.1, with a 1:2 BOG:Dwell ratio, Army force structure limits could be reached at just eight large WMD sites if operations were being conducted in a Hostile/High Threat environment, unless reserve component (RC) forces are mobilized. AC forces can cover 18 sites in an Uncertain/High Threat environment, or 34 sites in an Uncertain environment.

Without taking BOG:Dwell considerations into account, assaulting about 25 large WMD sites simultaneously or nearly simultaneously in a Hostile/High Threat environment, or slightly more than 50 sites in an Uncertain/High Threat environment,

³ Because it is obvious that company and platoon-sized WMD-E TFs would require fewer forces but scale in a similar way, we do not address these in our sensitivity analyses.

⁴ The Army is planning to reorganize its existing force of 45 AC BCTs into a force of 33 three-battalion BCTs by fiscal year 2017. DoD, “Army Announces Force Structure and Stationing Decisions,” News Release No. 461-13, June 25, 2013b. Ultimately the Army plans to inactivate an additional BCT. Ray Odierno, U.S. Army Chief of Staff, “CSA Press Conference on Army Force Structure Reductions,” press conference transcript, June 24, 2013.

would consume all of the 33 BCTs in the Army’s planned AC force structure.⁵ This analysis suggests that even a modest number of WMD-E TFs—e.g., the 12 we use in our base case below—would place a significant demand on U.S. Army force structure.

Using 30 days as our estimate for the average time to address a large facility such as those at Tuwaitha and al-Muthanna, we estimated the time required to complete a WMD-E campaign. The results are shown parametrically in Figure 4.2 as a function of the number of TFs employed, as well as the number of sites secured and searched.

Using the DPRK case to illustrate, 12 WMD-E TFs could exploit 12 sites in a 30-day campaign. The JTF commander, however, may deem it necessary to secure and exploit more sites—for instance, to secure newly discovered caches, follow leads on stolen or missing materials, or conduct a more comprehensive campaign. As the number of sites expands, the length of the campaign will expand as well. As shown in the figure, it would take 98 days for the same 12 WMD-E TFs to cover all 39 DPRK nuclear sites, 220 days to cover both these nuclear sites and 49 missiles sites, and 353 days to cover all 141 sites identified in the DPRK case. Covering more sites would obvi-

Figure 4.2
Nominal Time Needed to Complete WMD-E Operations Through the Exploitation Phase

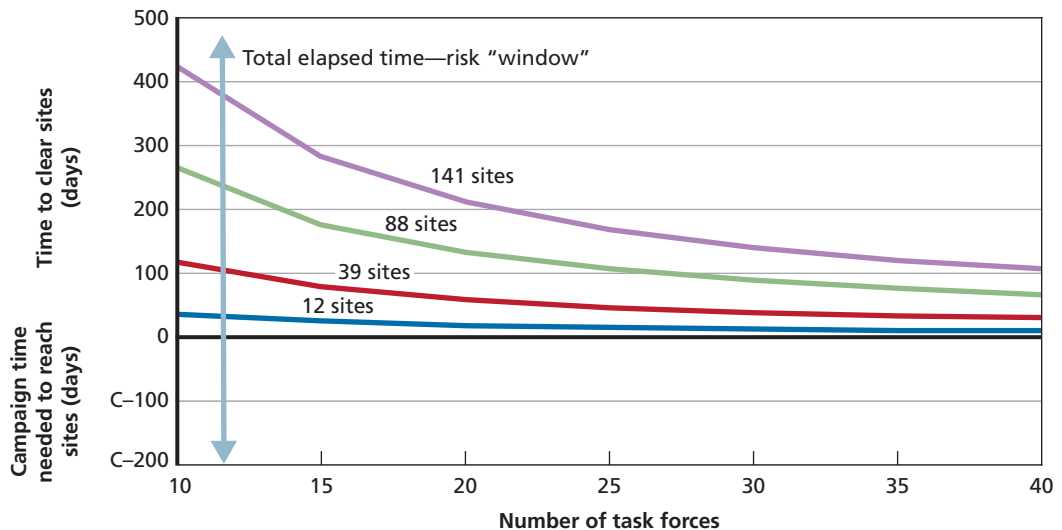

NOTE: The timeline described here only includes the time needed to complete the site-exploitation mission. The campaign time needed to reach the sites—including moving forces to the theater, maneuvering these forces to the sites, and conducting any combat operations—is not included and must be added. In addition, the time required to destroy any WMD or related technology beyond the 18 days estimated to exploit each site is not included in this estimate.

RAND RR541-4.2

⁵ We note again an important tradeoff between assigning additional combat forces to WMD-E TFs or retaining maneuver forces in the larger joint operation but assigning them to provide protection to the WMD-E TFs.

ously extend the campaign further—and, of course, if the average time for addressing a WMD site turned out to be longer, or some individual sites were contaminated or otherwise presented exploitation challenges, the campaign's duration would increase accordingly.⁶

The timeline described in Figure 4.2 only includes the time needed to complete the site-exploitation mission. The campaign time needed to reach the sites—including moving forces to the theater, maneuvering these forces to the sites, and conducting any combat operations—is not included and must be added. For example, if we were to call the day that the WMD-E TFs begin their secure-and-search operations Day C=0, and the TFs were able to reach their initial sites on the very first day of operations (e.g., by executing an airborne or airmobile assault), then zero days would be added to the campaign time needed to clear those sites. If no opposition or other obstacles prevented rapid movement to the next set of sites, then no campaign time would be added to the clearing time estimated earlier. On the other hand, if it took an accumulated campaign time of 200 days for the TFs to reach their target sites (indicated on the chart as Day C–200), then those days must be added to the campaign time. For instance, the total length of the campaign for ten TFs to secure and search 141 North Korean sites would be 200 days to reach the sites, plus 420 days to clear the sites, totaling 620 days. In addition, the time required to destroy any WMD or related technology beyond the 18 days estimated to exploit each site is not included in this estimate. That depends on such factors as the amount of material and equipment and the availability of follow-on—probably civilian—technical capabilities that would do the actual work of rendering safe, destroying, and transporting.

The total campaign length can also be shortened by a number of factors. First, the coalition might increase the number of TFs available to exploit sites. All other things being equal, the greater the number of WMD-E TFs, the shorter the campaign (if WMD-E is what drives campaign length). Second, some sites may be very small and—depending upon security at these sites—it may be possible to split a battalion TF into company- and platoon-sized units to explore more sites in parallel. Some sites may be “dry holes”—if these sites can be determined quickly, it may be possible to reduce the time needed at them. It may also turn out that several sites are aggregated together. For example, the Nuclear Threat Initiative (NTI) literature suggests that some chemical, biological, or nuclear sites may be located close to one another; hence, they might be exploited together by the same TF.⁷ Finally, allies, coalition partners, and Chinese forces might search some of these sites, thus reducing the demand for U.S. forces.

⁶ See Appendix B for a detailed discussion and listing of both North Korean and Syrian WMD sites.

⁷ NTI, *North Korea*, web page, undated-b.

Potential Contribution of Coalition Partner Forces

Forces of coalition partner nations could be employed to reduce the requirement for U.S. forces. However, the degree to which partner nation forces can substitute for U.S. forces will depend upon the size of these forces and how they would be employed.

Traditional U.S. allies—including North Atlantic Treaty Organization (NATO) allies and non-NATO allies and partners operating under the UN flag—may be able to provide important capabilities that augment or substitute for U.S. forces. However, the United Kingdom, France, Germany, and other allies are dramatically reducing their ground forces—making their future availability uncertain. Demographic and policy changes are also reducing the troop strength available from allies.⁸

In the DPRK case, South Korea has a large, skilled, and highly capable military that will almost certainly play a central role in any contingency on the Korean peninsula. RoK units assigned to the WMD-E mission would reduce the number of U.S. forces required. However, RoK forces might be assigned to very different mission priorities than those of U.S. forces—depending on how the crisis in North Korea begins and progresses. (Please see Appendix C for a more complete discussion of alternative crises and campaign designs.) For example, RoK forces may be tasked to neutralize North Korean artillery in range of Seoul and other South Korean targets. Securing the chemical arms these artillery units may be issued might also be a priority. RoK forces may also be assigned to provide humanitarian assistance in the face of an overwhelming need on the part of the North Korean civilian population—or to conduct security and stability operations after the collapse of the North Korean government. Finally, RoK forces might move rapidly to Pyongyang to secure military or political objectives. Depending upon the political context and U.S. security priorities, U.S. forces might assist RoK forces in some or all of these objectives—thereby lengthening the overall campaign—or focus on securing DPRK nuclear sites alone.

China also has large and capable forces. As we will describe later, China may push these forces into North Korea to provide a buffer zone to help manage refugees, prevent a mass movement into China, or simply control (as in “stake a claim to”) North Korean territory. China may decide to secure and eliminate WMD-E sites within any such zone or expand the zone to cover more such sites, thereby reducing the number of sites that U.S. forces need to secure.⁹

As a final note about potential coalition partner capabilities: Not all partner armies have the same level of logistics capabilities. One of the distinctive features of

⁸ See Michael Shurkin, *Setting Priorities in the Age of Austerity: British, French, and German Experiences*, Santa Monica, Calif.: RAND Corporation, RR-222-A, 2013. In addition, RAND colleague Bruce Bennett has reported that declining birthrates and the reduction in the length of compulsory military service are expected to cause the RoK to reduce its forces from 22 to 12 divisions in the early 2020s.

⁹ One caveat: The United States would want to ensure that these partner forces were diligent and complete in their exploitation efforts—and in securing seized weapons or materials from subsequent theft by terrorist or criminal organizations.

the U.S. military is its ability to sustain operations in austere environments over long periods of time. Some allies—such as Great Britain—have demonstrated this ability in past operations (e.g., the Falklands War). Others do not have the same enormous, and enormously complex, set of capabilities. Neither China nor South Korea have had to sustain operations away from its nation's civil logistics infrastructure for long periods of time.¹⁰ Though both can surely build such capabilities, it would require significant investment in the equipment, forces structure, and troops needed for these tasks that would then not be available for other combat and WMD elimination activities.

WMD-E Assault Aviation Requirements

Army assault aviation assets must be available for the seize-and-secure phase of WMD-E operations to reach vulnerable, high-priority sites quickly. Figure 4.3 presents our estimates of the number of combat aviation brigade (CAB) equivalents that would be needed. The figure presents the number of CAB equivalents (in red) and the number of assault battalions (in green) as a function of the sites to be assaulted simultaneously. The chart also notes the number of AC CABs available at a 1:2 BOG:Dwell ratio, and the total number of CABs in the AC.

At the limit, an assault aviation package might be provided to each WMD-E TF and remain with that TF for the duration of the operation. The Army had 13 CABs in the AC as of early 2013.¹¹ However, each CAB generally has only one assault battalion; this limits the number of WMD sites that can be air assaulted within a short time period.

Figure 4.3 shows that the required number of assault battalions for five large WMD sites would be 6.7—slightly exceeding the number available at a 1:2 BOG:Dwell ratio. The number of assault battalions for ten sites would be just over 13—exceeding the number of assault battalions in AC CABs. An additional eight assault battalions could be made available from the Army National Guard—making it possible to simultaneously assault 20 sites if both AC and RC forces are deployed for the duration of the conflict with no rotation.¹²

¹⁰ The brief 1979 Chinese invasion of Vietnam, for example, lasted less than four weeks and much of the heavy operations took place relatively close to Chinese territory. RAND colleague Bruce Bennett notes that much of the logistics capability of the RoK resides in the civilian sector.

¹¹ U.S. Army, *Fiscal Year (FY) 2014 Budget Estimates, Volume 1: Operation and Maintenance, Army Justification Book*, April 2013. There are several variants of the active CAB, but each has four helicopter battalions consisting of a general support aviation battalion, an assault helicopter battalion with UH-60s, and either two AH-64 equipped attack/reconnaissance battalions (ARBs) or 1 ARB and 1 OH-58D equipped attack/reconnaissance squadron.

¹² The Army National Guard has an additional eight CABs, two of which are organized as Heavy CABs similar to those in the active Army, and six of which are organized as Expeditionary CABs. An Expeditionary CAB has only one attack battalion. U.S. Army National Guard, *Combat Aviation Brigades (CABs) Within the Army National Guard*, web page, undated.

Figure 4.3
Number of CABs Required for WMD-E Operations at 5 to 50 Large WMD Sites

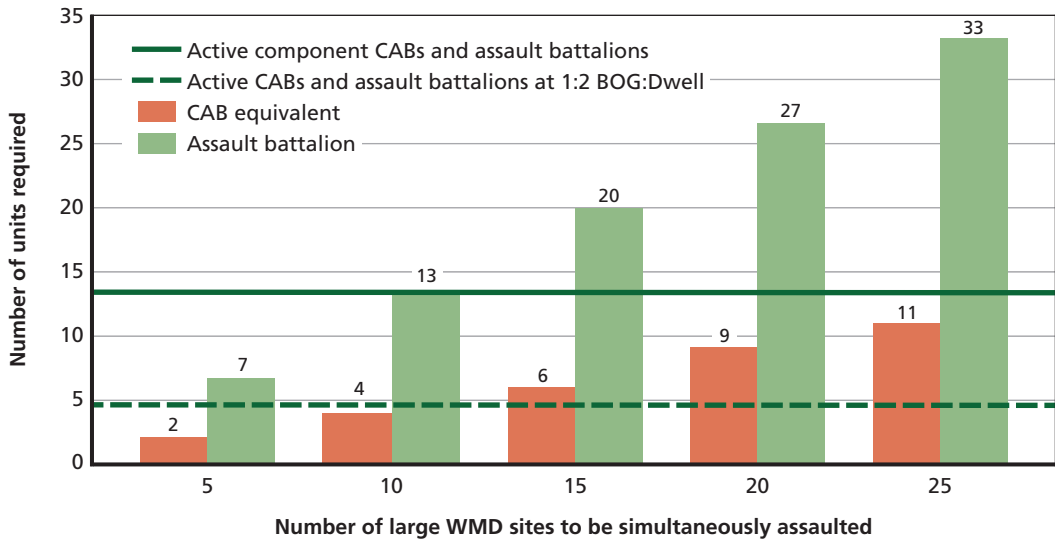

RAND RR541-4.3

Given these limits, it might be necessary for a smaller number of assault aviation packages to be assigned to the WMD-E mission, with these assets providing support for multiple assaults. For example, if one conceived of initial assault operations unfolding over several days, four assault aviation packages might be able to carry four WMD-E TFs to assault their targets on the first day and then reroll to support a second and third wave of four assaults over each of the next two days.¹³ As suggested by Figure 4.3, however, even four sites could stress the available number of AC assault battalions.¹⁴

WMD-E Chemical Unit Requirements

We also conducted a brief assessment of WMD-E TF requirements for chemical units, and their availability in the AC. Figure 4.4 illustrates the potential requirements for CBRN units associated with WMD-E operations at an increasing number of sites. The number of CBRN units required scales with the number of WMD sites to be exploited concurrently.

Figure 4.4 focuses on two classes of CBRN units in the AC's force structure: chemical companies (maneuver support) and chemical companies (technical escort). As of mid-2013, the Army's AC has 14 chemical companies (maneuver support), each

¹³ One could plan for four waves of three assaults, six waves of three assaults, and so on, but this would obviously reduce the degree of simultaneity in these operations.

¹⁴ It may be possible to augment the Army aviation assets with Marine Corps, SOF, Navy, Air Force, fixed-wing (for airborne) and allied aviation assets to extend these capabilities further.

Figure 4.4
CBRN Units Required to Conduct WMD-E Operations at 5 to 25 Large WMD Sites

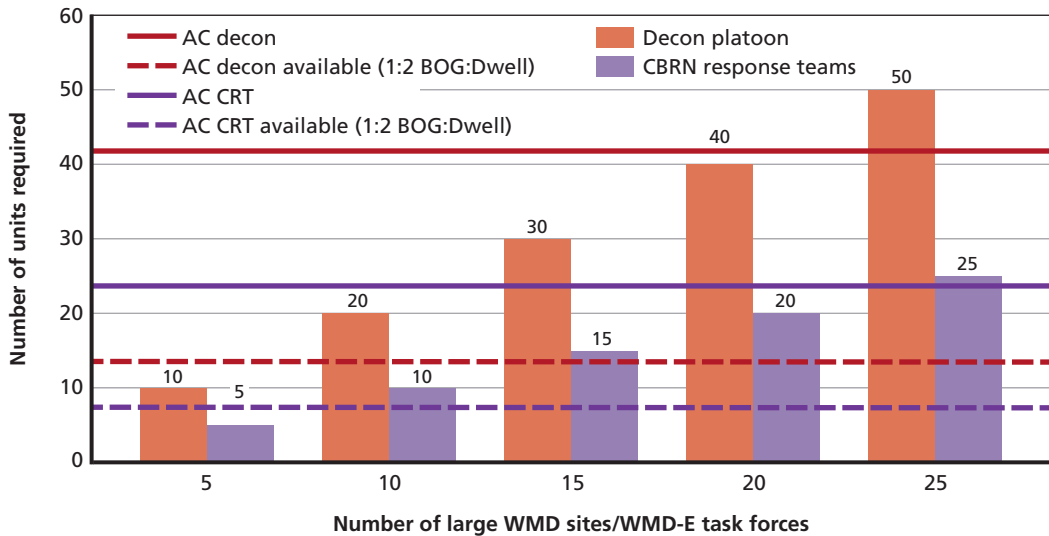

NOTE: Decon = CBRN decontamination platoon.

RAND RR541-4.4

of which consists of a headquarters element, one CBRN reconnaissance platoon, and three CBRN decontamination platoons, some of which can be internally reorganized as hazardous response teams.¹⁵ The Army also possesses six chemical companies (technical escort) in the AC, each of which has four CBRN response teams (CRTs).¹⁶ The U.S. Army thus has the ability to field 42 decontamination/hazardous response platoons and 24 CRTs from its current force structure, provided some units were retrained. Assuming a 1:2 BOG/Dwell cycle, 14 decontamination/hazardous response platoons and eight CRTs should be immediately available for deployment at any given time.¹⁷

In addition, significant CBRN decontamination capability resides in the U.S. Army’s RC. Army National Guard and Army Reserve chemical companies (area support) and chemical companies (maneuver support) have some 165 additional decontamination platoons. Given the RC’s BOG:Dwell ratio of 1:4, about 33.6 of these platoons could be available to support the AC.

As can be seen in Figure 4.4, ten large WMD sites require about 143 percent of the immediately available CBRN decontamination platoons in the AC and 42 percent

¹⁵ After the information cut-off date for this report, the Army began a process of restructuring its CBRN force. The data used here are current as of mid-2013.

¹⁶ There are no RC CRTs.

¹⁷ This is a simplification of actual readiness rates as two chemical companies (area support) and a chemical company (technical escort) are forward-deployed to Korea.

of the available total force units. CRTs are particularly scarce, and they do not exist in the RC. For ten large sites, 125 percent of the immediately available force is required. Depending upon other claims on these forces, this could represent a shortfall.

Case 1. State Loses Control Over Its Nuclear Weapons

Illustrative Scenario: The Democratic People's Republic of Korea (DPRK)

DPRK Nuclear, Chemical, Biological, and Missile Sites

Little reliable information exists on the DPRK's WMD program.¹⁸ For our illustrative analysis of WMD-E force requirements, we have used the NTI dataset of WMD facilities. The NTI draws upon multiple official, published, and press sources to provide an open source list of actual, potential, and rumored facilities.¹⁹ Though it may miss some real facilities and may include facilities not actually associated with a WMD program, it is a useful unclassified proxy for the DPRK's WMD programs. Importantly, it does not include tactical WMD storage facilities (e.g., for CWs), which could be numerous—depending on whether the DPRK forces prepare for war before the regime collapses. Finding, examining, and rendering safe WMD in these tactical sites would be a significant task involving large numbers of troops.²⁰ Table 4.1 presents the results of our analysis of data from the NTI on the DPRK's WMD and missile programs.²¹

As shown, we estimate that the DPRK's WMD and missile programs include approximately 141 sites (excluding tactical sites) identified as being of potential interest for WMD-E operations,²² 39 of which are associated with its nuclear program, 38 are

¹⁸ For instance, it is unclear how much of the DPRK's CW stockpile remains reliable. It is believed that the DPRK relies on unitary CW munitions, which may degrade over time. Recent economic problems and shortages may have led to a halt or reduction in CW agent production. NTI, *North Korea: Chemical*, web page, undated-c.

¹⁹ Please see Appendix B for a more detailed discussion of our analyses using the NTI data. Please note: No such list—especially one compiled from unclassified sources—will completely describe the WMD programs in a nation as secretive and closed as the DPRK. Our purpose here is to utilize these open-source estimates to set a floor on the potential demand for ground forces.

²⁰ In 2000, the Secretary of Defense estimated that North Korea possessed 12,000 artillery pieces with 8,000 of them garrisoned within 100 miles of the RoK. See Office of the Secretary of Defense, *Report to Congress: Military Situation on the Korean Peninsula*, September 12, 2000. As an example, if North Korea has 5,000–6,000 artillery pieces along the DMZ, that would comprise approximately 100 regiments (18 tubes/battalion, 3 battalions per regiment). To be conservative, if CWs were assigned at regimental level (versus battalion or battery levels), that would add 100 regimental garrisons to the list of sites that would need to be searched for these weapons. It could be that only some regiments are actually issued chemical munitions—but it may be impossible to determine which are and which are not before they are searched. A more recent study by the Office of the Secretary of Defense indicates that North Korea has 8,500 field artillery pieces and 5,100 multiple rocket launchers for 13,600 total. See Office of the Secretary of Defense, 2013, p. 12.

²¹ Our analysis of the NTI data on DPRK WMD and missile sites is described in detail in Appendix B.

²² Some aggregation of sites was undertaken for cases in which multiple facilities were co-located. For example, we have counted the 19 facilities identified by NTI as being located at the Yongbyon Nuclear Research Center as a

Table 4.1
Notional DPRK WMD Target Set

Site Category	Total Sites	Highest Priority Sites	Other Sites
Nuclear	39	9	30
Missile	49	9	40
Chemical	38	15	23
Biological	15	10	5
Total	141	45	96

SOURCE: NTI; RAND estimates.

related to its CW program, and 15 are related to its bioweapons (BW) program. An additional 49 sites are associated with the ballistic missiles that might launch WMD.

For WMD-E operations, we assess that the order of priority of these sites would be:²³

1. Nuclear fuel enriching and processing sites, and nuclear weapon manufacturing, testing, and storage sites
2. Missile garrisons holding missiles capable of carrying nuclear weapons
3. Research and development sites and nuclear-related universities
4. Other nuclear sites—including mines, low-grade ore processing
5. Biological weapons research and development, manufacturing, testing, and storage sites
6. CW research and development, manufacturing, testing, and storage sites.

Unclassified sources identify nine sites in the DPRK that fall into the first category: Yongbyon Nuclear Research Center, one nuclear test site, four additional undeclared nuclear enrichment sites, one suspected underground nuclear storage site, one undeclared underground enrichment and reprocessing site, and one site associated with nuclear weaponization.²⁴ These nine nuclear sites are shown in Figure 4.5.

single site, and we have combined some facilities that were listed under two categories (e.g., the Yongbyon Nuclear Research Center was listed under research and development as well as under fuel fabrication) or under two types (e.g., the Hamheung University of Chemical Industry was listed under both nuclear and chemical facilities). We arrived at the totals listed above after accounting for such dual entries. See NTI, undated-b. This accounting does not include potential tactical unit storage facilities, nor the many potential tactical-level sites to which WMD weapons could be dispersed as tensions rise.

²³ Caches containing complete nuclear weapons would be an even higher priority—but, as we will discuss, such caches would be more effectively secured with SOF and other quick-response forces. Here, we focus specifically on the missions that would be best assigned to WMD-E TFs.

²⁴ NTI, undated-b. While differing in their particulars, other sources provide comparably low numbers of key DPRK nuclear sites. GlobalSecurity.org reports that the DPRK has “as many as 22 nuclear sites at 18 locations,” while the International Institute for Strategic Studies identifies eight major nuclear program facilities and Interna-

We also have included nine missile sites as priority targets for WMD-E, interdiction, or attack operations in Figure 4.5 because they would be the sites most likely to launch nuclear weapons if and when such weapons are integrated with North Korean ballistic missiles. (They may also be a priority if they were likely to launch CWs.)

The figure also depicts a notional buffer line that might be established by Chinese forces—50 km in this example—in the event that China decides to establish a zone within North Korea to control the flow of refugees or otherwise manage further developments on the peninsula. An interesting feature of such a zone would be the number of priority WMD and missile sites remaining outside it. In this notional case, five nuclear and seven missile sites would remain on the U.S. side. We will discuss the implications of this number in the next section of this chapter.

A key operational decision—and one that will be greatly affected by the quality of available intelligence—will be whether and in what priority to seize and reduce each site. The combined commander/JFC would then develop a campaign plan to exploit these and any other sites found during the course of operations. One approach could be to seize and secure all of these sites soon into the campaign but to exploit them in priority order—so that lower-priority sites are exploited after the WMD-E TFs complete their operations at higher-priority sites.

Campaign Design

A WMD-E campaign would balance key objectives and missions; strategic, operational, and tactical risks; and the joint forces needed to interdict, attack, and/or eliminate nuclear forces and sites quickly enough to minimize the risks of proliferation or use.²⁵ The speed with which individual WMD-E TFs make their way to the highest-priority WMD sites will depend on several factors, including the ground scheme of maneuver chosen for the joint campaign. The WMD-E maneuver scheme could adopt one or a combination of the following approaches: (1) a northward movement of U.S. ground forces and RoK allies across the DMZ along one or more axes of advance; (2) the introduction of forces from the sea on one or both coasts to reduce the distances that ground forces need to advance to reach priority nuclear WMD sites; and/or (3) air maneuver operations involving airborne or air assault forces directly assaulting the highest-priority sites, with other ground forces maneuvering to meet up with these forces, and joint SOF, air, and naval forces supporting.²⁶ Generally speaking, maneu-

tional Crisis Group identifies three major DPRK nuclear warhead sites. Our parametric analysis of the number of sites ranges from five to 50. See GlobalSecurity.org, *Weapons of Mass Destruction*, web page, undated; International Crisis Group, *North Korea's Nuclear and Missile Programs*, Asia Report No. 67, June 18, 2009, p. 30; and International Institute for Strategic Studies, *North Korean Security Challenges: A Net Assessment*, July 2011, pp. 28–29.

²⁵ Please see Appendix C for a discussion of campaign design and the key factors likely to influence it.

²⁶ Aerial assaults could be conducted either using rotary-wing assets in assigned combat aviation brigades, as in the illustrative scenario we used, or by units like the 82nd Airborne Division or 101st Airborne (Air Assault) Division. The Marine Corps also has capabilities to directly insert forces using its organic aircraft.

Figure 4.5
Priority DPRK Nuclear and Missile Sites

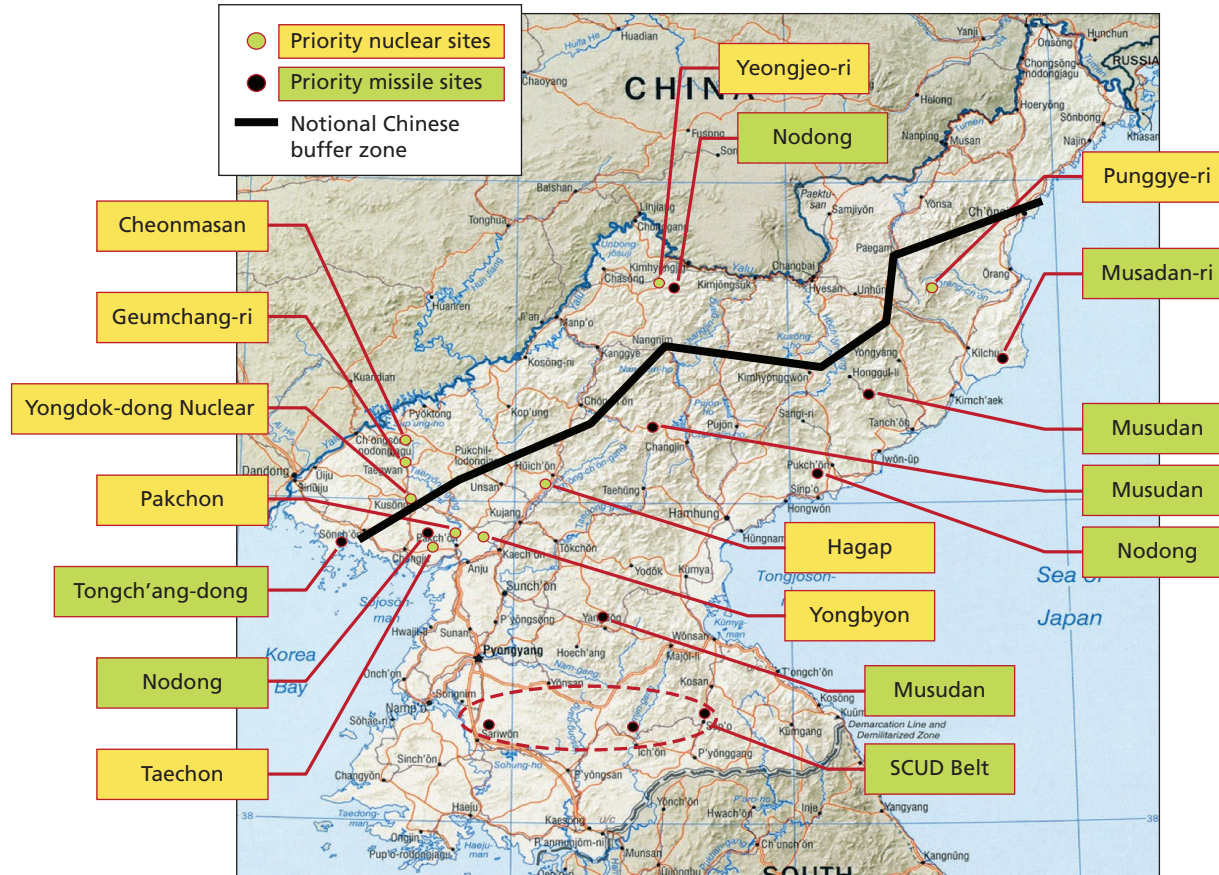

RAND RR541-4.5

ver forces from the larger joint force would provide security for the WMD-E TFs, help isolate target facilities, and create the necessary local security conditions for the TFs to carry out their missions.

Each of the three approaches listed above involves associated benefits and risks. For example, a northward advance would establish secure areas for elimination operations but could also be quite slow, and such an advance could well face the greatest concentration of opposing DPRK forces—hence, the highest casualties, especially if those DPRK forces had the ability and will to fight.²⁷ The approach based on operationally maneuvering from the sea could also face stiff opposition, and it would introduce some logistical challenges, but it would also shorten the distances—and potentially the time—that maneuver and WMD-E TFs have to advance to key DPRK nuclear and missile sites in the north. Finally, the air assault option might be the fastest way to seize DPRK nuclear sites until the WMD-E TFs arrive, but this approach could leave the assault forces exposed and isolated. Tradeoffs between risks and timelines also exist: Some risks might be mitigated, for example, by conducting heliborne assault operations against a site only when heavier ground maneuver forces are closing on that site so that assaulting forces can be quickly reinforced.

Another key tradeoff is between the amount of risk accepted and the number of DPRK nuclear sites to be targeted in the initial assault. As indicated by our parametric analyses, the greater the number of sites assaulted by WMD-E TFs, the lower the risk that nuclear weapons can be employed or that weapons, components, materials, technologies, or know-how can proliferate. However, the greater the number of sites assaulted, the greater the associated force requirements. In practice, it seems likely that the forces provided to the joint commander will reflect an effort to minimize the risk of proliferation at some acceptable level—subject, of course, to relevant force constraints.

The highest-priority targets will be those forces or facilities suspected of holding complete nuclear weapons and systems capable of employing them on short notice. These will almost certainly be assigned to special operations, airborne, and airmobile forces—along with appropriate technical teams—for interdiction or attack operations.²⁸ Next would be sites suspected of holding nuclear weapons but not ballistic missiles, aircraft, or long-range artillery capable of employing them. These would be priorities for immediate seizure by airborne and airmobile forces, when such seizures are

²⁷ This would also eliminate the artillery threat to the RoK and potentially secure much of the DPRK's weaponized CW arsenal. It would also neutralize the bulk of the DPRK's organized combat forces. A ground advance will need to occur in any case, unless there is a permissive environment or we have been invited in by an actor that controls much of the DPRK and its military.

²⁸ Counterproliferation of WMD is a core SOF mission. See DoD, *Special Operations*, Washington, D.C., JP 3-05, April 18, 2011a, and U.S. Special Operations Command, *Special Operations Doctrine*, MacDill Air Force Base, Fla., USSOCOM Publication 1, August 5, 2011. As early as the 1993 defense review known as the Bottom-Up Review, improvements in the ability of both general purpose and special operations forces to seize, disable, or destroy arsenals of nuclear, biological, and chemical weapons and their delivery systems were ordered.

consistent with acceptable military risk as described above. Depending on the potential opposition expected, forces seizing both categories of sites would be augmented with additional quick-response air and ground forces.

In addition, some key scientists and other personnel from the targeted WMD program may be in the process of attempting to proliferate weapons, materials, or documents when WMD-E operations begin. Intelligence, special operations, and other quick-response forces will be responsible for interdicting such proliferation attempts.

Ground-mobile WMD-E TFs, operating as part of a larger JTF, would be assigned to other high-priority but less time-sensitive elimination missions against DPRK nuclear facilities. Additional high-priority sites include weapons production, enrichment, reprocessing, testing, and other nuclear sites containing those components or materials posing the greatest proliferation or transfer risks.

After WMD-E TFs have completed their identification, search, seizure, and securing work at a site, they may turn over responsibilities for transportation and destruction of weapons, components, materials, and technologies to “follow-on” military or civilian forces, and move on to the next nearby high-priority site.²⁹ Additional follow-on military forces may be needed to continue securing the site. Although the technical and security requirements for follow-on operations could be considerable, we lack any basis for estimating the personnel that might be required for these operations, since it would depend on the specific characteristics of each site, the security situation at the time, and various other factors. To some degree, these forces might be drawn from the security and support forces included in our force calculations below.

We also assume that joint or coalition forces comprising part of the larger operation will encounter other facilities, caches, or cantonments as they advance. Sometimes these targets of opportunity will be a surprise; at other times, they will be sites already suspected of harboring WMD but assigned a lower priority for exploitation and reduction. When such sites are encountered, the JTF commander will need to determine whether to divert advancing WMD-E TFs to reconnoiter or exploit the target site or to seize and secure it with maneuver forces for elimination operations later.

Intelligence Requirements

The quality and reliability of U.S. intelligence will be critical in winnowing the number of sites to be initially assaulted, seized, and secured down to those that will best reduce the risk of WMD being leaked or employed. The accuracy of this intelligence will be a critical force-driver, since it will shape assumptions about how many sites need to be secured to achieve some minimal acceptable level of risk. For example, poor intelligence can result in forces being sent to seize and secure sites bereft of WMD, or lead

²⁹ RAND colleagues Bruce Bennett and Jim Quinlivan have developed the concept of “back-end” forces. These forces might be host-nation forces (e.g., RoK forces in the case of the DPRK scenario) that remain long after the initial operation has been completed in order to finish the task of destroying or removing weapons and materials that have been secured.

to them overlooking critical facilities, or cause them to arrive at facilities too late. Very good intelligence could, in theory, reduce the number of sites requiring coverage, support the efficient allocation of limited resources, and reduce risk. (In practice, however, North Korean efforts to hide weapons and disguise sites may significantly diminish the effectiveness of U.S. and allied intelligence.)

Two intelligence issues complicate planning for the WMD-E mission. First, intelligence gaps will likely mean that critical facilities rumored or reported to exist cannot be located. Such gaps could entail large efforts to find these reported but unlocated sites. This problem highlights the critical importance of intelligence in supporting both WMD-E operations and analysis of the threat in general, as well as the need to aggressively exploit human and other intelligence sources acquired after operations start.

Second, as previously noted, many weapons—particularly CWs—are likely to have been dispersed to numerous tactical operational sites that cannot be identified in advance and are not included in estimates of a country's WMD infrastructure. As a result, U.S. and allied forces are almost certain to encounter previously unknown sites at unexpected times. U.S. and RoK forces will not know if they have found all of them with any degree of certainty until the entire region is secure, operations reach an advanced stage, and personnel from these sites have been identified, interrogated, and debriefed. This implies a long-term effort, and it may take months or even years to fully account for weapons, components, and materials taken from the sites. This also means that U.S. forces may have to continue to assist in the search for a long time.

To a large extent, the problem of maneuver forces encountering weapons caches falls outside of the WMD-E TF paradigm as laid out in current doctrine. The prospect of coming upon previously unidentified sites during operations suggests a need to provide maneuver forces with some minimum capability to secure and monitor such sites until they can be handed off to other units for elimination or consolidation. Rather than assigning this task to WMD-E TFs, TTP need to be developed and promulgated throughout maneuver units and their support elements to guide them in how to locate, secure, and identify such caches. In addition, the likelihood of encountering unidentified WMD suggests the need to have a WMD-E TF capability in reserve, one that can deal with unanticipated but large and complex sites.

In fact, what constitutes a WMD-E TF is a critical element of operational design for the JTF commander. For the WMD-E mission in North Korea, even in a DPRK collapse scenario, forces searching for WMD will not know what type of resistance they might encounter. TFs should consist, therefore, of both WMD specialists and general-purpose forces that are adequate for the potential threat and tactical situation. This could be a significant consideration given the nature of North Korea's armed forces and the degree to which its population is armed and indoctrinated to fear and distrust U.S. and RoK forces.

Parametric Analyses of WMD-E Force Requirements

We estimated WMD-E forces under different scenario assumptions that varied the following parameters:³⁰

- the number and sizes of WMD sites for WMD-E operations
- force requirements dictated by the operational environment
- the ratio of supporting forces to mission forces.

The number and sizes of WMD sites for WMD-E operations. Ideally, a JFC would like to seize and secure every WMD-related site immediately. However, forces and other resources will always be constrained—thereby limiting the number of sites that can be simultaneously seized, secured, and exploited. As mentioned earlier, JFCs will need to prioritize these sites and apportion forces between WMD-E and other missions. Joint doctrine prescribes that, in coordination with the intelligence community, geographic combatant commanders will develop a WMD-E target list that is prioritized in some fashion (e.g., primary or secondary)³¹—for example, on the basis of the risk posed for leakage, proliferation, or use of weapons, components, or materials.³² For purposes of estimating the needed number of WMD-E TFs, we began with the highest-priority sites for the initial phase of WMD-E assault operations as described earlier. The highest-priority sites of all would be nuclear weapons deployed with aircraft or missiles. These would be the target of special operations and airborne or airmobile forces conducting WMD interdiction or WMD attack operations.

For WMD-E operations, we assess that the nuclear sites associated with fuel enriching and processing would be the next priorities, along with nuclear weapon manufacturing, testing, and storage sites. Any WMD-E campaign would seek to seize and search these sites first. Other nuclear, missile, and chemical or biological sites could be seized and secured but exploited later. We will demonstrate here that even this relatively small number of sites could require significant conventional ground forces.³³

For our base case, we selected 12 battalion TFs as the minimum force that a commander should be allocated to seize, secure, search, and eliminate the priority nuclear sites. We note that 12 WMD-E TFs is a planning factor only—conditions on

³⁰ See Appendix C for the scenario context involved in the case of the DPRK.

³¹ DoD, 2009, p. A-13.

³² U.S. Army, *Chemical, Biological, Radiological, Nuclear, and High Yield Explosives Operational Headquarters*, Washington, D.C., FMI 3-90.10, January 2008, p. 4-3 states: “Planning should provide a target/site list prioritization method weapons of mass destruction master site list (WMSL) for determining which sites should be exploited.” It also notes that sites on the target list are “planned targets,” while those inadvertently discovered in the course of operations are “opportunity targets.”

³³ The Nonproliferation Treaty does not permit RoK forces to acquire nuclear weapons, components, highly enriched uranium, or plutonium, so sites likely to contain these would need to be covered by U.S. or Chinese forces.

the ground may very well call for more or fewer. For example, if intelligence suggests that the highest-priority nuclear activities should be conducted at nine sites, as shown in Table 4.1, then a minimum of ten battalion-sized TFs should be assigned to these nine sites. This includes two for Yongbyon (given its great size) and one each for the remaining eight sites. Alternately, if the threat conditions did not permit access to 12 high-priority sites simultaneously, those not needed for these most critical sites would be used on less critical ones.³⁴

Two additional battalion TFs should be held in reserve to exploit high-priority “pop-up” targets—such as caches at missile basing sites or additional sites that might be discovered by intelligence or maneuver forces. As mentioned before, some of these TFs may need to be airmobile if they are to quickly reach sites suspected of containing nuclear weapons.

In the course of an operation, the U.S. commander might use these 12 WMD-E TFs differently. For example, recall that in Figure 4.1 four of the priority nuclear sites and two of the priority missile sites were located approximately 50 km from the Chinese border. In case the Chinese advance into North Korea to establish a buffer zone, the United States and China could reach an agreement that these sites would be secured and reduced by Chinese forces—leaving U.S. forces to reduce five of the priority nuclear sites and seven priority missile sites.

Operational environment and force requirements. We describe in greater detail the potential causes of a DPRK regime collapse and the resulting operational environment in terms of the four threat levels defined in Chapter Three:

- *WMD-E (Uncertain)*: This environment features a low threat level—consistent with the collapse of the DPRK regime and complete disintegration of the military. This might occur if a power struggle within the Kim regime resulted in open fighting that pushes an already dangerously unstable economy and society into chaos and collapse. Depending upon how fragile DPRK institutions are, this could result in an extended civil war. A more optimistic result might be for former regime officials to reach out to their South Korean counterparts to make some sort of deal—perhaps an offer to form a regime friendly to the South in exchange for immediate economic and security aid. The deal might include a resolution to eliminate the DPRK’s WMD programs, as well as an agreement to accept a combined effort by Chinese, South Korean, U.S., and international forces to accomplish this mission, stabilize the society, and provide humanitarian aid. Establishing such conditions on the ground would require substantial joint and coalition

³⁴ We argue that the United States should have at least 12 such TFs ready to exploit the highest-priority nuclear sites immediately if the threat situation on the ground allows such simultaneous exploitation. If, on the other hand, these sites can only be reached after a long, slow advance from the DMZ, then these TFs would be available to help search other potentially dangerous nuclear, missile, biological, and chemical sites until the nuclear sites could be secured. As a result, we will use 12 as the minimum number of WMD-E TFs in the following analysis.

forces inside North Korea. In this and all cases below, therefore, WMD-E TFs would have to rely on their organic maneuver battalions to protect themselves and secure the WMD and related facilities—with additional air and ground forces on call to respond to surprise attacks.

- *WMD-E (Uncertain/High Threat)*: This environment features a greater threat level—consistent with the collapse of the DPRK regime and the higher echelons of its military. As in the Uncertain case above, this environment might arise from a violent conflict within the DPRK’s leadership. In this case, however, some military units may remain coherent up to regiment (or brigade) level—perhaps to maintain a hold on supplies of food or other resources. Forces of this size and capability could wreak havoc against convoys or pose serious opposition at a WMD site. Therefore, any potential appeal by former regime officials for humanitarian and security aid in return for giving up their WMD programs carries higher levels of tactical risk. Substantial joint and coalition forces, which are not included in this estimate, will be needed to establish wide area security. We assigned the U.S. commander charged with WMD-E a CAB for every three battalion TFs in the command and a maneuver battalion for each of the ten battalion TFs assigned to a specific North Korean nuclear site. (Two battalion TFs reserved for pop-up targets would presumably be accompanied by other maneuver forces.) An MP company is also assigned to each battalion TF to provide security for LOC.
- *WMD-E (Hostile)*: This environment features the collapse of the DPRK regime and disintegration (or destruction) of its higher military echelons. This environment might result from an internal regime struggle and subsequent collapse, as before, or it might be the consequence of combat with South Korean and U.S. forces that leads to the destruction of North Korean C2, warfighting infrastructure, and major military units. Either way, the basis of the Hostile environment is that U.S. entry into North Korea would be met with hostility by former regime and military members and perhaps many in the general public. In the internal collapse case, entering North Korea might be predicated on relieving a massive humanitarian catastrophe and controlling refugee flows—with securing WMD being necessary to prevent their transfer, as well as a necessary condition to safeguard ongoing operations from attack. In the case involving combat, securing the DPRK’s WMD program might be a tactical and strategic imperative for ending the conflict. In both cases, substantial joint and coalition forces would be needed to establish wide area security and to defeat remaining regime forces. We assigned an additional maneuver battalion and MP company to each of the ten battalion TFs assigned to a nuclear site.
- *WMD-E (Hostile/High Threat)*: This environment features the collapse of the DPRK regime but with the military remaining intact to a large extent. This environment might result from an internal regime struggle and collapse as before—

but, in this case, the military manages to hold itself together. Although this situation would certainly be preferable to a North Korean attack on the South, it could pose a uniquely difficult set of problems, including widespread starvation among the North Korean population and refugee flows across both borders; violence by regime remnants against civilians—to wrest control of food and other resources and to repress riots; a breakdown in military authority, which could increase the chances of a bombardment by the artillery units holding Seoul and other South Korean population centers at risk; and theft of WMD, components, and equipment by former regime officials. In the midst of these challenges, U.S. entry into North Korea would be met with hostility by former regime and military members and perhaps many in the general public. Substantial joint and coalition forces would be needed to establish wide area security and to defeat attacks by significant, intact North Korean military units.³⁵ We assigned an entire maneuver BCT to each of the ten battalion TFs allocated to priority nuclear sites, as well as three additional BCTs for LOC security among sites and other coalition forces.

We used these four environment descriptions to calculate the forces required for the missions shown in Table 4.2. In each case, we assessed that a battalion-sized WMD-E TF was the minimum size needed to provide sufficient organic security at each site and that—at a minimum—12 such TFs would be provided (ten for priority nuclear sites, with two in reserve for pop-up targets).³⁶ Each would have a hazardous response and a decontamination platoon, a CBRN reconnaissance squad, and a CBRN response team. Ideally, each would also have a nuclear disablement team, although 12 such teams may not be available, which means that the WMD-E TFs will have to share these units across their operations.³⁷ The equivalent of four BCTs would be required to provide the maneuver, headquarters, and supporting elements of these TFs.

In each case, a follow-on force would need to relieve the WMD-E TF so it could proceed to its next objective, as discussed in Chapter Three. If these follow-on forces are provided by the U.S. Army, they would generate a requirement in addition to those articulated in the table above. For example, a WMD-E TF might hand each site over to a follow-on force built on a maneuver company or troop. If each nuclear and missile site needed a company to remain, a total of 76 company-sized units would be required

³⁵ We do not assess the forces needed to forcibly disarm an intact North Korean state, or to conduct WMD-E operations in the face of opposition by Chinese military forces. Both environments represent challenges outside the scope of this effort.

³⁶ As mentioned earlier, these WMD-E TFs might be precluded from quickly reaching their priority nuclear and missile sites in hostile and high-threat environments. In such cases, they might be employed to secure other dangerous nuclear, biological, chemical, or missile sites as coalition forces advance.

³⁷ These numbers are derived from doctrine used for the purpose of this analysis. In reality, the actual forces will be modified as needs change.

Table 4.2
Notional WMD-E Unit Force Requirements for Minimum Number of Highest-Priority Sites

Operating Environment	WMD-E TF	Assault Aviation	Seize and Secure Forces ^a	LOC Security	Total BCT-equiv Requirement
Uncertain	12 battalion TFs 12 hazardous response platoons 12 decontamination platoons 12 CBRN reconnaissance squads 12 CBRNE response teams Nuclear disablement teams	4 CAB	None	None	~4 ^b
Uncertain/ High Threat	12 battalion TFs 12 hazardous response platoons 12 decontamination platoons 12 CBRN reconnaissance squads 12 CBRNE response teams Nuclear disablement teams	4 CAB	2.5 BCTs	12 MP companies (combat support)	~7
Hostile	12 battalion TFs 12 hazardous response platoons 12 decontamination platoons 12 CBRN reconnaissance squads 12 CBRNE response teams Nuclear disablement teams	4 CAB	5 BCTs	12 MP companies (combat support)	~9
Hostile/ High Threat	12 battalion TFs 12 hazardous response platoons 12 decontamination platoons 12 CBRN reconnaissance squads 12 CBRNE response teams Nuclear disablement teams	4 CAB	10 BCTs	3 BCTs	~17

SOURCE: RAND analysis.

NOTE: Table reflects U.S. Army force structure and nomenclature as of mid-2013.

^a We assume that a BCT can provide four battalions by task organizing its three maneuver battalions and its reconnaissance squadron.

^b In addition to these forces, follow-on forces will be needed for this mission. How many and which nation will provide them will be situation dependent. See the following short discussion.

(88 total nuclear and missile sites from Table 4.1 minus the 12 sites being serviced by WMD-E TFs)—or, more than six additional BCTs.³⁸

Similarly, it is important to note that in higher-threat environments, WMD-E TFs will require quick reaction force (QRF) support from allied forces in the sectors in which they will be operating. This seems a reasonable assumption, as WMD-E will not be the only mission being conducted—massive humanitarian assistance missions, stabilization missions, and perhaps combat and other missions will be going on simultaneously. QRFs to support all forces operating in theater are assumed to be in place and not included in the troop counts above.

³⁸ As a minimum, planners would need to assume that each site suspected of nuclear weapons material, personnel, or documentation had a U.S. follow-on unit, due to the requirements of the Nonproliferation Treaty.

We also summarize the assault aviation and security force requirement in terms of CABs, BCTs, and security company equivalents. Each operational environment would require four CABs to provide assault aviation,³⁹ while zero, two and a half, five, or ten BCTs were required to assist in seizing and securing WMD sites.

Finally, 12 MP companies were assigned to provide LOC security in the intermediate-threat cases, while three full BCTs of maneuver forces were utilized for LOC security in the Hostile/High threat case.

Ratio of supporting forces to mission forces. Echelon-above-brigade (EAB) support forces include everything other than the BCTs that the Army would deploy in support of a joint operation. Thus they include combat forces such as fires brigades, combat support forces such as battlefield surveillance brigades and MP units, and combat service support units such as truck companies, hospitals, and supply units.

Based upon recent historical experience, we posit three different ratios of EAB support forces to mission forces (i.e., the “tail-to-tooth ratio”). These ratios are calculated based upon U.S. Army experience in OIF and Operation Enduring Freedom (OEF) and include a significant amount of contractor support. However, for operations in the DPRK, such support would most likely be provided by military units:

- 1.5:1: This represents the lower-end bound of OIF and OEF support for Army operations.
- 2.5:1: We use this ratio for our baseline. It represents the midlevel support ratios experienced in OIF and OEF.
- 3.5:1: This represents the high-end bound of OIF and OEF support.⁴⁰

We chose the 2.5:1 support ratio for our baseline estimate to support WMD-E operations in the DPRK, and show the parametric variants of ratios higher or lower than this number.

Sensitivity of Force Requirements to Operational Environments and Support Ratios

Ground force requirements for WMD-E operations in our illustrative DPRK case are presented in Figure 4.6. The ground force requirements are presented as a function of the operating environment (Uncertain or Hostile, and level of threat) and the assumed support ratio (low, midlevel, or high), broken out by the different elements of the WMD-E mission force.

As shown in this figure, estimated forces needed for WMD-E operations could be:

³⁹ The assault aviation units would be required to ensure that QRFs would be available to defeat opposition to the WMD TFs or the follow-on forces relieving them. If the tactical situation permits, they may also be used to conduct air assaults against priority nuclear or missile sites.

⁴⁰ Appendix D provides a review of available estimates of support ratios in Iraq, and illustrates the consequences of different support ratios in calculations of the required forces in the DPRK and Syria.

Figure 4.6
WMD-E Land Force Requirements for Minimum Number of Highest-Priority DPRK Sites

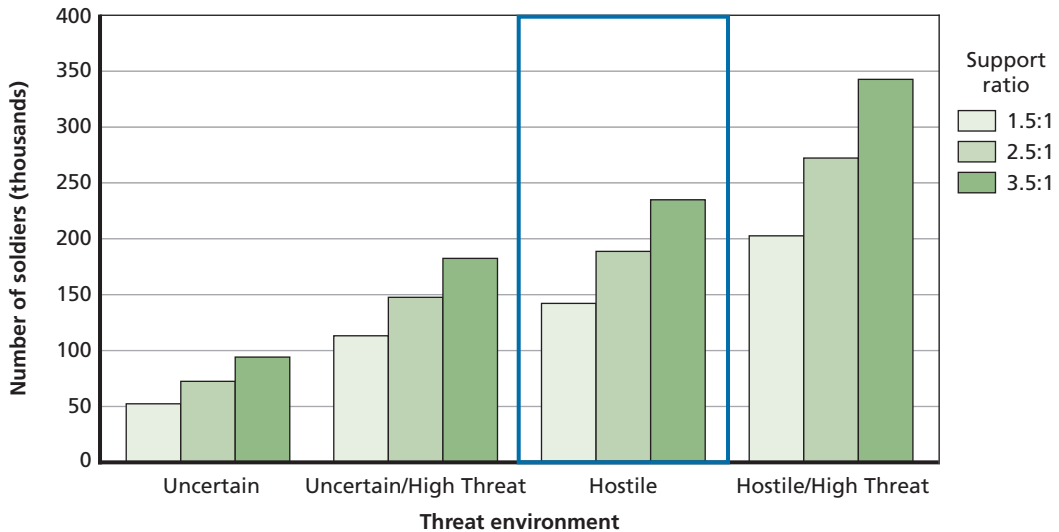

RAND RR541-4.6

- 73,000 troops for an Uncertain environment—with a lower bound of 52,000 if significant contractor logistics support can be employed and an upper bound of 94,000 if all support must be provided by the U.S. military
- 148,000 for an Uncertain/High Threat environment—with a lower bound of 113,000 with more contractor logistics support and an upper bound of 182,000 with all U.S. military support
- 188,000 for a Hostile environment (inside the box in Figure 4.6, signifying that we believe this to be the most plausible case)—with a lower bound of 142,000 if more contractor logistics support is involved and an upper bound of 235,000 if only U.S. military provides support
- 273,000 for a Hostile/High Threat environment—with a lower bound of 202,000 for more contractor logistics support and 343,000 for all U.S. military support.⁴¹

Since we think that the environment is likely to be Hostile and that the intermediate level of support will be needed in the DPRK, our best estimate is a requirement for 188,000 U.S. ground troops. That estimate could decrease to 148,000 if the risk of attack from DPRK military remnants decreases, or it could increase to 273,000 if

⁴¹ Please note that the support forces include logistics units and every form of combat support and combat service support needed in field operations. These include combat engineers, aviation, headquarter functions, communications, intelligence, etc. In addition, Appendixes E and F—not available to the general public because they contain analysis based on information with restricted distribution—break out estimated personnel numbers by TF element.

the environment worsens to become High Threat. It is also useful to recall that these estimates are for the WMD-E mission only—they do not include force requirements for other missions, such as humanitarian assistance and disaster relief or an operational reserve that might be required if combat were to break out with DPRK regime remnants (or if tensions erupted with Chinese forces operating in close proximity).

Finally, it should be noted that these different security levels pertain to the disposition of the DPRK security forces and any insurgent forces that might rise up. In the case of a Chinese intervention on the side of the DPRK, this would no longer be a WMD-E mission and a different analysis would be needed to articulate force requirements for such a conflict.

Observations on the DPRK Case Study

As described in this case study, WMD-E operations in the wake of a collapse of the DPRK could be one of the most stressing cases that U.S. forces might encounter. That said, our analysis suggests that force requirement estimates are highly sensitive to a range of assumptions. Among the key assumptions driving results are the following:

- the number and sizes of the WMD sites that are to be searched, the time needed to clear each site, and the priority and urgency of clearing them
- the degree to which non-U.S. forces could or would be relied upon to service nuclear and nonnuclear sites
- the ratio of support to mission troops
- the degree of hostility in the operational environment, as well as the military threats WMD-E forces may face.

The WMD-E requirement is a nontraditional mission that creates a need for forces in addition to those required for joint operations, the force requirements of which might already be quite large. Historically speaking, this task has not been accounted for in either operational or force structure planning. Potentially significant additional forces could be required for other counter-WMD operations (e.g., WMD interdiction, active and passive defense, or consequence management), not to mention the larger joint operation in which WMD-E operations are embedded (e.g., combat or stability operations). To maintain our focus in this report on the force requirements associated with WMD-E operations, we have not examined any of these other force requirements at an equivalent level of detail.

Our results suggest that even in cases where relatively favorable assumptions are made, the estimated U.S. forces required can still be quite substantial: For example, in our DPRK base case, our estimate for the Uncertain environment—a relatively favorable environment for conducting WMD-E operations—required an estimated 73,000 troops, while a more hostile operating environment or more expansive missions required significantly more troops: *If our lower bound estimates, which are based*

on reasonably optimistic assumptions, produce large troop numbers, actual WMD-E operations are likely to be far more challenging. We would expect that the force numbers actually required would be still higher.

Case 2. State Use or Loss of Control Over CWs: Illustrative Scenario: Syria

We also established a notional scenario for parametric analyses of the potential force requirements associated with WMD-E operations against a relatively small number of chemical WMD sites in Syria.⁴²

Syria is among a small set of nations—which the intelligence community believes to include Iran and North Korea—that has (until very recently) possessed an active CW program.⁴³ The presence of CWs in Syria was confirmed when they were used in an attack that killed 1,400 civilians in August of 2013.⁴⁴ The Assad regime denied responsibility for the attack—claiming that rebel forces were to blame. However, these chemical rounds were employed by specialized artillery units—making it highly likely that the Syrian Army fired these rounds, whether authorized by Assad or not. The growing Syrian civil war, moreover, gave rise to concerns that these weapons might be lost from state control, lending additional urgency to DoD efforts to build the capabilities needed to eliminate such loose WMD.

The widespread media coverage of this chemical attack and its effects on civilians—including women and children—shocked the world and led to calls for military action to punish or remove the Assad regime. Subsequent negotiations among the United Nations, Russia, Syria, and the United States resulted in an agreement by which Syria would identify and destroy its CWs, materials, and related industrial processes under the supervision of the Organization for the Prohibition of Chemical Weapons.⁴⁵

The agreement framework specified that Syria would declare all sites containing CWs or production equipment. In addition, the framework laid out an ambitious schedule for the elimination of Syrian CWs and related materials, including:

⁴² This analysis reflects developments on the ground in Syria, and some longer-term challenges and risk analyses that will endure beyond immediate events. The information cut-off date for this scenario was February 21, 2014.

⁴³ See ODNI, *Unclassified Report to Congress on the Acquisition of Technology Relating to Weapons of Mass Destruction and Advanced Conventional Munitions, Covering 1 January to 31 December 2011*, Washington, D.C., February 2012.

⁴⁴ See Joby Warrick, “More Than 1,400 Killed in Syrian Chemical Weapons Attack, U.S. Says,” *Washington Post*, August 30, 2013.

⁴⁵ See U.S. Department of State, “Framework for Elimination of Syrian Chemical Weapons,” September 14, 2013; United Nations, *U.N. Security Resolution 2118*, September 27, 2013; and OPCW, “Decision: Destruction of Syrian Chemical Weapons,” September 27, 2013a.

- completion of initial OPCW on-site inspections of declared sites by November 2013
- destruction of production and mixing/filling equipment by November 2013
- complete elimination of all CW material and equipment in the first half of 2014.⁴⁶

These have proven to be challenging timelines to meet—particularly the third one.⁴⁷ Even with the staunch support of the United Nations, United States, and Russia, and the extraordinary actions of the OPCW, several factors could have made this timeline unachievable.

First, Syria might have decided to omit some weapons locations from its disclosures—or even to move or hide some weapons; instead, the OPCW and the United States have judged that the Syrian regime provided what appears to be a surprisingly complete declaration.⁴⁸ (The Ghadaffi regime in Libya failed to disclose all of its chemical weapons stockpile when it agreed to eliminate its chemical weapons program under OPCW supervision. After the fall of the Ghadaffi regime, several hundred weapons were subsequently found hidden in previously undisclosed sites.)⁴⁹

Second was the estimated geographic scope, which was, before the Syrian declaration, assumed to involve approximately 50 sites located around Syria.⁵⁰

Third was the rather inhospitable operating environment. While Iraq and Libya also featured several large sites at various locations, CW elimination operations were conducted when these nations were under tight regime control—that is, in the absence of hostile factions with the ability to interfere in WMD-E operations. OPCW opera-

⁴⁶ U.S. Department of State, 2013.

⁴⁷ For example, Syria missed a December 31, 2013, deadline to export the most dangerous chemicals, and by early February 2014 only about 4 percent of the total was said to have been removed from Syria. See Rick Gladstone, “Russia Says Syria Will Export Chemicals by March 1,” *New York Times*, February 4, 2014. By mid-February, an estimated 11 percent of Syria’s CW stockpile had been removed from the country, but this was only a tiny percentage of what should have been removed by February 5, 2014. See Salma Abdelaziz and Jim Sciutto, “OPCW: Only 11% of Chemical Weapons Removed from Syria,” CNN, February 13, 2014.

⁴⁸ As of November 2013, OPCW inspectors had verified 22 of the 23 declared CW sites. According to an OPCW update, as of October 28, 2013, in total, the Syrian Arab Republic had submitted information on 41 facilities at 23 sites (18 CW production facilities, including filling facilities, 12 CW storage facilities, eight mobile filling units, and three CW-related facilities), approximately 1,000 metric tons of Category 1 CWs (largely binary CW precursors), approximately 290 metric tons of Category 2 CWs, and approximately 1,230 unfilled chemical munitions. OPCW, “Note by the Director-General: Progress in the Elimination of the Syrian Chemical Weapons, Programme,” November 26, 2013b.

⁴⁹ “In November 2011 and February 2012, the new Libyan government declared a ‘previously undeclared chemical weapons stockpile’, consisting of several hundred munitions loaded with sulfur mustard.” OPCW, Libya: Facts and Figures, web page, undated.

⁵⁰ For example, while the Syrians declared a total of 23 CW-related sites, the United States had earlier identified 45 potential sites, and suggested that about half of them had “exploitable quantities of chemical weapons.” See Michael R. Gordon and Nick Coming-Bruce, “Syria Meets First Test of Accord on Weapons,” *New York Times*, September 20, 2013.

tions in Syria were conducted while a civil war was under way. Security was provided by the Syrian Army—but they may have been unable to secure some sites from attack or unwilling to commit sufficient forces to this mission rather than fighting the rebel forces. The security task was magnified by the plan to transport chemical munitions out of Syria for destruction—making convoys vulnerable to attack and theft.

Fourth, the effort to destroy CWs in Syria was always expected to be large in scale, and potentially time-consuming as well. Past experience indicated that destruction of all weapons, chemical agents, and industrial components could take up to a year or more to complete.⁵¹ During this time, the security of WMD-E operations might have deteriorated to the point that they were suspended, the Syrian regime could have lost control of important sites, or the Assad regime could have collapsed entirely.

Finally, the Syrian government could have chosen to end its cooperation with the OPCW and abrogate its agreement. After the attack, President Barack Obama asked Congress for the authority to use military force, and UN diplomatic sources threatened to refer Syria to the UN Security Council for action if Syria reneged. Even though Russia had been unwilling to approve military action against Syria, the Obama administration had strongly implied that Syrian use of CWs could provoke a U.S. military response.⁵² The United States also might have responded with military force if Syrian rebels—especially extreme Islamist factions—managed to capture one or more CW caches, or if the Syrian military suddenly collapsed, rendering all CWs vulnerable to rebel capture.

Each of these factors—and especially the potential of the Syrian government to lose control of some CWs or sites before they could be destroyed—argues strongly for the relevance of the Syrian case to any assessment of the scale of WMD-E capabilities that might be needed across a range of scenarios.

Syrian Chemical, Biological, Nuclear, and Missile Sites

As we mentioned in the last section, Syria has provided an inventory of their CW program as part of the framework agreed to with the UN, Russia, and the United States. However, that framework has not been made public—and does not include the bio-

⁵¹ In the Syria case, destruction of the materials will be conducted on a U.S. ship. As a practical matter, once the materials are out of Syria, Syria will have effectively been demilitarized of its chemical capabilities.

⁵² Recent reporting suggests that President Obama's "red line" comment was an unscripted remark that departed from agreed U.S. policy at the time. See Peter Baker, Mark Landler, David E. Sanger, and Anne Barnard, "Off-the-Cuff Obama Line Put U.S. in Bind on Syria," *New York Times*, May 4, 2013, and Andrew Rosenthal, "Government by Random Comment," *New York Times*, May 6, 2013. Nonetheless, on June 13, 2013, it was reported that "[the] intelligence community assesses that the Assad regime has used chemical weapons on a small scale against the opposition multiple times in the last year," and it was announced that the United States would begin providing arms to the rebels. See Mark Mazzetti, Michael R. Gordon, and Mark Landler, "Syria Has Used Chemical Arms on Rebels, U.S. and Allies Find," *New York Times*, June 13, 2013, and Mark Mazzetti, Michael R. Rogdon, and Mark Landler, "U.S. Is Said to Plan to Send Weapons to Syrian Rebels," *New York Times*, June 13, 2013.

logical or nuclear programs that Syria had been suspected of supporting. In the absence of Syria's detailed report, we used the NTI assessment and other public sources to estimate Syria's total WMD programs as shown in Table 4.3.⁵³

As described in Table 4.3, our analysis of the NTI data suggests that as of summer 2013, the Syrian WMD and missile programs included approximately 45 sites of potential interest for WMD-E operations.⁵⁴ Twelve of these sites were believed to be involved with Syria's CW program (seven of which we judge to be high-priority sites), one was associated with biological warfare research, and 23 were believed to be associated with Syria's nuclear research program. Other open-source information suggested that some seven high-priority Syrian facilities might have been directly involved in the production and storage of CWs.⁵⁵

In addition, according to the ODNI, Syria could have delivered its CW agents by aerial bombs, ballistic missiles, and artillery rockets;⁵⁶ NTI estimated that an additional nine sites were associated with the production and deployment of long-range missiles,

Table 4.3
Notional Syrian WMD Target Set

Site Category	Total Sites	Highest-Priority Sites	Other Sites
Chemical	12	7	5
Biological	1	0	1
Nuclear	23	0	23
Missile	9		9
Subtotal	45	7	38
Rocket/Aircraft Caches	20	20	0
Total	65	27	38

SOURCE: NTI; RAND estimates.

⁵³ Our analysis of the NTI data on Syria's WMD and missile sites is described in detail in Appendix B.

⁵⁴ The total number of sites associated with Syria's chemical program, including weapon storage sites associated with operational units, has been estimated to be as high as 50. See Barbara Starr, "Military: Thousands of Troops Needed to Secure Syrian Chemical Sites," CNN, February 22, 2012.

⁵⁵ See NTI data on Syrian WMD facilities. NTI identifies an additional four potential dual-use facilities, primarily oil refineries and fertilizer plants, and a research and development facility in Damascus. NTI, *Facilities Displayed with Google Maps*, web page, undated-a.

⁵⁶ James R. Clapper, *Statement for the Record: World Wide Threat Assessment of the U.S. Intelligence Community*, Senate Select Committee on Intelligence, March 12, 2013, p. 8. Syria is not believed to be able to produce all of the precursor chemicals required for CW and needs to import them from foreign sources. ODNI, 2012, p. 7.

with another 20 CW caches associated with rocket and aircraft delivery systems. We depict a dozen of the more notable chemical sites and aircraft bases in Figure 4.7.

For the purposes of assessing WMD-E TF requirements, however, we began with a smaller set of targets for the initial phase of a WMD-E operation: Out of 23 CW-related sites divulged by Syria to the OPCW,⁵⁷ we assumed that as these facilities were closed and their capabilities neutralized, Syrian CW stocks and precursors might have been consolidated into fewer sites.⁵⁸ Accordingly, we assumed in our scenario that

Figure 4.7
Exemplar Syrian Chemical and Airfield Sites, Summer 2013

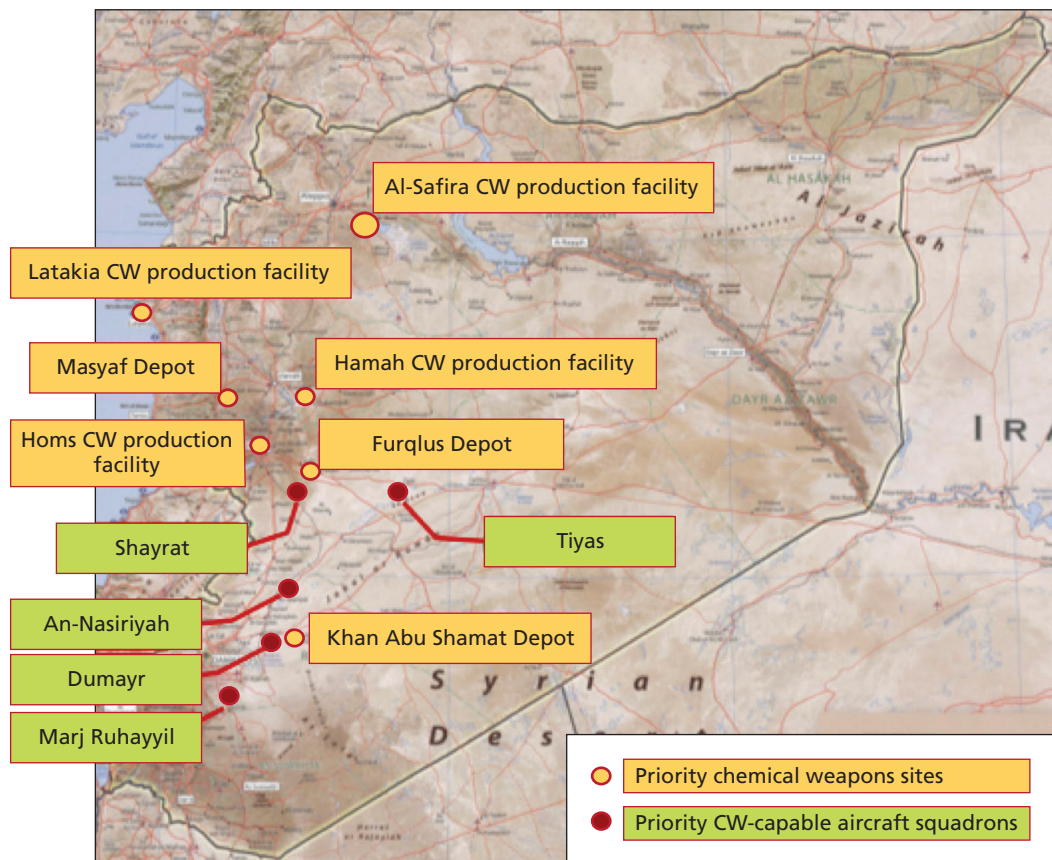

RAND RR541-4.7

⁵⁷ As a detailed listing of sites in the OPCW accounting is unavailable, it is impossible to reconcile differences between the NTI's and OPCW's numbers of sites.

⁵⁸ We did not consider Syrian nuclear or biological sites as high-priority targets because the policy focus has been on CWs. Moreover, the Syrians appear not to have had a particularly active nuclear weapons program since the reported destruction of an undeclared and unfinished nuclear reactor by the Israeli military in September 2007, or perhaps due to other military or technical issues. See ODNI, 2012.

the operational focus for a notional future military intervention would be a few such high-priority sites. For reasons of force protection and risk mitigation, we assumed that a brigade-sized force would be the smallest military unit that the United States would introduce into even a relatively benign, post-civil war Syria. A brigade-sized force would yield four battalion-sized WMD-E TFs—enough to secure four highest-priority CW sites. Once these sites were addressed, the WMD-E TFs could move on to other chemical sites.

Missions, Objectives, and Campaign Design

It is plausible that in the case of Syria, a JFC might have used one or a combination of avenues of advance for his forces to reach Syrian chemical WMD targets. These could include ground or air movements from Turkey or Jordan, and/or amphibious or air assault operations from the Mediterranean. U.S. forces also could operate in concert with Turkish, Jordanian, or other partners.⁵⁹ As needed, maneuver forces from the larger joint force would escort the WMD-E TFs and isolate their target facilities, creating the necessary local security conditions for the WMD-E TFs to carry out their missions.

Parametric WMD Elimination Force Requirements Analysis

To analyze conventional ground force requirements for WMD-E operations, we use the same parameters that were used for the DPRK case: the number and sizes of WMD sites to be assaulted concurrently; the operational environment (Uncertain, Uncertain/High Threat, and Hostile); and the ratio of support forces to mission forces (1.5, 2.5, or 3.5).

The number of ground forces required depends on the specific operational environment those forces will face:

- *WMD-E (Uncertain)*: As described earlier, this environment would feature a low risk to U.S. operations, comprising irregular forces operating independently and occasionally attacking when they seek some direct benefit.⁶⁰ WMD-E TFs would have been able to enter Syrian WMD sites without a combat assault, and operate with acceptable risk relying upon their organic maneuver units. This environment is not unlike what U.S. forces faced in Iraq in 2007. In this case, the threat to U.S. WMD-E efforts could include irregular forces with local organization, as well as regional terror groups capable of conducting larger-scale attacks—like the one that struck the Tiguentourine gas plant in Algeria in January of 2013.

⁵⁹ The United States has, for example, been training Jordanian military forces to assist in WMD-E operations. See Ernesto Londoño, “U.S. Military Team in Jordan Planning Ways to Deal with Syria’s Chemical Weapons,” *Washington Post*, June 18, 2013.

⁶⁰ The reader will recall that JP 1-02 defines an “uncertain” environment as an “[o]perational environment in which host government forces, whether opposed to or receptive to operations that a unit intends to conduct, do not have totally effective control of the territory and population in the intended operational area.”

Such conditions on the ground would require that WMD-E TFs have enough organic combat capability to protect themselves and the WMD and related facilities being secured—with additional air and ground forces on call to respond to surprise attacks.

- *WMD-E (Uncertain/High Threat)*: A more dangerous course for the Syrian civil war would be for Syria to devolve into a patchwork of rival autonomous regions, resulting in a somewhat higher threat to U.S. forces. This threat environment might feature irregular forces, including *salafi-jihadi* groups that would oppose a western intervention, as well as Assad loyalists and Hezbollah and Iranian Revolutionary Guards supporting the Assad regime—and possibly some Syrian regular forces—capable of conducting frequent, coordinated attacks against U.S. and coalition forces. In this environment, WMD-E units would need to conduct air assaults on sites and clear them of irregular forces, and would need additional maneuver units assigned to them for force protection. Accordingly, in this scenario, we add two combat aviation brigades, as well as a maneuver brigade, and four MP companies to the overall WMD-E JTF to provide for site perimeter and LOC security.
- *WMD-E (Hostile)*: U.S. forces entering Syria prior to the dismantlement of its CW program would have needed to be prepared for a Hostile environment featuring a significant threat of organized opposition from surviving Syrian conventional units up to brigade strength in some cases. The JTF commander would have to assign maneuver units to provide wide area security, secure LOC, and operate with WMD-E TFs in seizing and securing WMD sites. To respond to potential threats, three additional BCTs (one armored BCT and two Stryker BCTs) and four additional MP companies would be deployed to shield the WMD-E TFs from attack by Syrian Army maneuver forces (in cases where they remain) or larger formations of hostile irregular forces.⁶¹
- We dropped the Hostile/High Threat environment because it seemed implausible that the United States would forcibly disarm Syria.

Table 4.4 summarizes the major elements of WMD-E TFs that are required in each of the notional operational environments just described. We note, again, that these estimates do not include any additional joint forces needed to deter or defeat opposition by Syrian Army remnants, to conduct stability or humanitarian assistance operations, or to defeat air or ballistic missile attacks or mitigate the effects of WMD attacks.

For our illustrative analysis, we begin with a WMD-E TF organized around four battalion-sized WMD-E TFs and various supporting technical units, creating a force package that is suitable for four large CW sites in an Uncertain environment. The TFs could eventually revisit all declared and suspected Syrian WMD and associated missile

⁶¹ This case most resembles the reported Joint Staff estimate of 75,000 troops for a WMD-E mission in Syria.

Table 4.4
Notional Syria Unit Force Requirements for Four Priority Sites

Operating Environment	WMD-E TF	Assault Aviation	Additional Security	LOC Security	Total BCT Requirement
Uncertain	4 battalion TFs 4 hazardous response platoons 4 decontamination platoons 4 CBRN reconnaissance squads 4 CBRNE response teams	None	None	None	~1
Uncertain/High Threat	4 battalion TFs 4 hazardous response platoons 4 decontamination platoons 4 CBRN reconnaissance squads 4 CBRNE response teams	2 CAB	1 BCT	4 MP company (combat support)	~2
Hostile	4 battalion TFs 4 hazardous response platoons 4 decontamination platoons 4 CBRN reconnaissance squads 4 CBRNE response teams	2 CAB	4 BCTs	8 MP company (combat support)	~5

SOURCE: RAND analysis.

NOTE: Table reflects U.S. Army force structure and nomenclature as of mid-2013.

and aircraft sites in battalion strength. Moreover, if security conditions improve, or if additional maneuver units are assigned to provide security, it may be possible to deploy all CBRN squads or other technical units simultaneously to reconnoiter more sites. As described above, two combat aviation brigades, a BCT, and four MP companies are added for the Uncertain/High Threat environment, and three more BCTs and four additional MP companies are added for the Hostile environment.

Figure 4.8 summarizes the WMD-E force requirements for Syria under base case assumptions about the target set and mix of TFs required to execute the mission. As shown in the figure, estimated ground force requirements for WMD-E operations range between 15,000 and 138,000 depending on the specific assumptions made:

- Estimated ground force requirements for an Uncertain environment are about 21,000 troops at a 2.5:1 support ratio, but could be 28,000 troops at the 3.5:1 support ratio, or fall to 15,000 troops at a 1.5:1 support ratio.⁶² Once again, a force this small would only be appropriate if U.S. forces faced rather minimal organized resistance to WMD-E operations.
- Estimated ground force requirements for an Uncertain/High Threat environment are nearly 58,000 at a 2.5:1 support ratio, with 42,000 at a 1.5:1 ratio, and nearly 74,000 at a 3.5:1 support ratio. More troops would be required in this environment to address the increased risk of organized, irregular resistance to U.S. operations.

⁶² We believe that a support ratio of 2.5:1 is the most realistic one for the Syria case.

Figure 4.8
WMD-E Land Force Requirements for Notional Syrian Site List

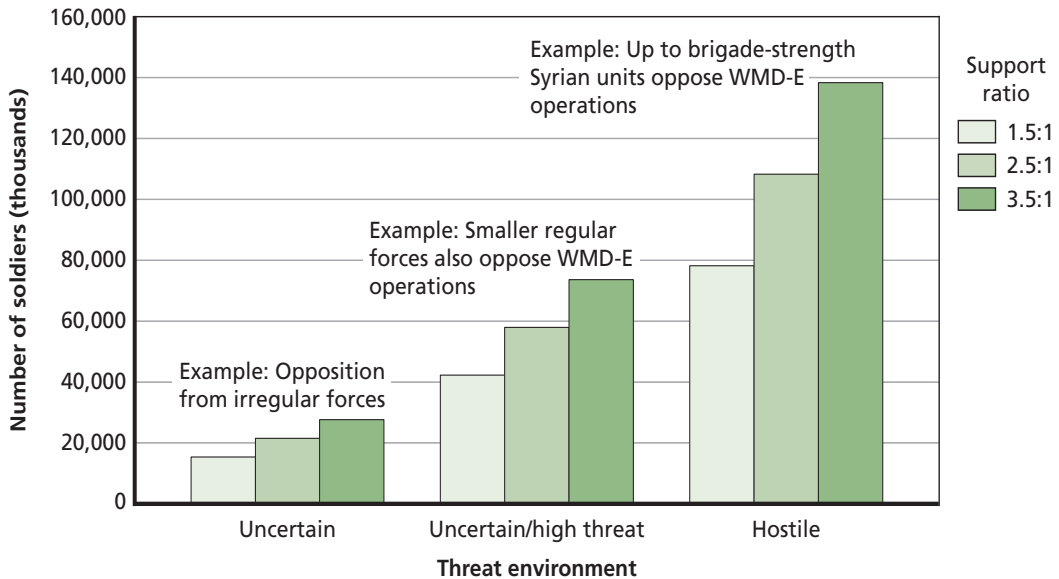

SOURCE: RAND analysis.

RAND RR541-4.8

- Estimated ground forces required for the Hostile environment are 108,000 soldiers at a 2.5:1 support ratio (the case we judge to be most plausible), with 78,000 at a 1.5:1 ratio and 138,000 troops at a 3.5:1 support ratio.⁶³ More troops are required for this environment due to the significant risk of organized, regular, and irregular resistance to U.S. operations.

If a WMD-E mission had been conducted in Syria prior to the recent dismantlement of its CW program,⁶⁴ we believe that it would most likely have been conducted in a threat environment most similar to the Hostile environment we describe.⁶⁵ Therefore, troop numbers in the range of approximately 78,000 to 138,000 would be needed to clear the suspected Syrian WMD sites and provide adequate force protection to

⁶³ Appendixes E and F— not available to the general public because they contain analysis based on information with restricted distribution—break out the personnel numbers by the elements of each TF.

⁶⁴ As of February 2014.

⁶⁵ Chairman of the Joint Chiefs of Staff GEN Martin Dempsey made the following assessment of a potential intervention in Syria: “If we had to go in there, it would be nonpermissible. If it was a hostile environment, it would be a significant intervention.” Karen DeYoung, “Pentagon Sending Additional Troops to Jordan,” *Washington Post*, April 17, 2013. It is our judgment that an intervention in the DPRK would carry even greater risks.

WMD-E forces. To the extent that contracted logistics support is unlikely to be available in the midst of a civil war, our best estimate is the midrange of 108,000 soldiers.

Observations on the Syrian Case Study

Although the ground force requirements of WMD-E operations in a WMD-capable Syria do not appear nearly as significant as in the DPRK case, the Syrian case study reveals that the ground force requirements associated with WMD-E operations conducted in the midst of a civil war can be quite substantial. Again, these force estimates do not include the maneuver forces that would be needed if the WMD-elimination operations were opposed by significant elements of the Syrian Army; nor the forces associated with stability, humanitarian, or other operations that might be assigned to the joint or coalition force.⁶⁶

Summary

To better understand the potential ground force requirements associated with WMD-E operations, this chapter assessed potential counter-WMD operations in the DPRK and in a counterfactual case in Syria that might be conducted as part of a larger joint or combined campaign. Analysis of WMD-E requirements for our notional DPRK and Syria cases included results of the parametric analyses we conducted of potential WMD-E force requirements, which varied the level of threat in the operational environment, an assumed ratio of supporting to mission-specific troops, and the number of WMD sites to be secured simultaneously.

These analyses point to a convergent finding: The potential ground force requirements associated with WMD-E are substantial; they could consume most or all of the Army's ground maneuver and assault aviation forces. There are two key implications of this finding. First, it is crucial for JFCs—not just WMD specialists—to understand WMD-E operations and consider carefully, in their contingency and operational planning for such locales as the DPRK and Syria, the potentially large force requirements associated with these operations. Second, the potential claim of WMD-E operations on available Army force structure is sufficiently high that DoD resource policy decisions involving Army force structure should include consideration of the conventional ground force requirements of WMD-E operations.

In addition to the sorts of WMD-E TFs considered in this chapter, there is a range of cases—for example, acquisition of a nuclear weapon by a terrorist group or rebel military faction—that involve smaller, more discrete, and possibly more time-sensitive threats that probably require strike, special operations, and airborne assets for

⁶⁶ We thus find highly plausible press reports of estimates that the total force for operations in Syria could total 75,000 personnel or more—especially when these collateral missions are considered.

WMD interdiction, offensive operations, or active defense operations. We also note that there may be other, larger cases—e.g., Iran—the success of which could hinge more on the successful employment of military force in a coercive role than the conduct of WMD-E operations. In the end, however, our central point is that it is crucial to develop a better understanding of the force requirements associated with WMD-E operations across a wider range of scenarios than we have examined here.

A final point: When considering joint campaigns that include WMD-E operations, U.S. commanders, Defense secretaries, and Presidents will be faced with the decision of whether to go in small—assuming a permissive or uncertain, nonhostile case—or big—in case the situation (though it may seem relatively permissive) turns hostile. The danger of going in small is obvious: No leaders will want WMD-E forces to become easy targets for the large and still-capable combat forces among which they would be operating. Enemy attacks could constrain further WMD-E operations until larger forces arrive; since these additional forces (not part of the original plan) arrive much later, weapon sites would remain unguarded and unsecured. A wiser alternative might be to go in big—with a larger, more capable force that can help to minimize the risk of WMD proliferation or use. As conditions become more favorable and WMD are secured, commanders can taper their deployment of additional combat forces.

Concluding Observations

As established at the beginning of this report and reiterated throughout, the past two administrations have consistently proclaimed countering WMDs—particularly nuclear weapons—to be the highest priority objective of national security and military strategy. The grave and urgent priority of these strategic *ends* are not in dispute. In addition, this report has shown that DoD has made important progress in developing some of the *ways* of countering WMD—in particular, it has developed relevant doctrine, CONOPS, and organizational templates for counter-WMD missions.

There is little comparable evidence, however, that DoD has adequately considered the *means* that may be required to address these missions and, perhaps especially, the WMD-E mission area and its ground force requirements. The analyses presented in this report indicate that ground force requirements associated with WMD-E, as well as with other counter-WMD missions, could be quite substantial indeed—potentially rivaling more traditional scenarios used as the basis for sizing military capacity and determining the military capabilities required.

To close this national strategy–resource policy gap, the report concludes by suggesting that DoD should:

- promote countering WMD in general and WMD-E in particular to the status of missions that drive resourcing priorities—in terms of both military capacity (force size) and military capabilities (force structure)
- assess the force requirements for counter-WMD and WMD-E missions across a wide range of scenarios and in both contingency and operational campaign planning
- perform a capabilities gap analysis of counter-WMD and WMD-E operations within the Joint Capabilities Integration Development System.

Furthermore, DoD should evaluate counter-WMD and WMD-E force requirements in current and future defense reviews, paying particular attention to the risks associated with WMD-E operations in view of the simultaneous missions that need to be performed. To this end, DoD should also assess the number of large WMD-E TFs needed for simultaneous WMD-E operations within a single large counter-WMD

scenario. Finally, this report suggests that the size, complexity, joint nature, and strategic importance of WMD-E operations will require that DoD assign a JTF-capable headquarters to oversee these operations. As the JTF would combine WMD specialists with a large number of combat and support forces, this could not be a strictly specialized formation. Because a WMD-E mission could happen on short notice, these headquarters would need to be prepared to execute it with little preparation. And, as JTF-capable headquarters are few, it could not be the only mission for such an outfit.

The Army should consider preparing each of its three corps for this mission. Since I and III Corps have geographically focused missions, they would be the logical choice to act as JTF-Elimination in the Pacific Command and Central Command theaters, respectively, while the XVIII Airborne Corps could be available worldwide. Each would need to train for this mission, and with the specialized units and other capabilities that are not part of a corps' normal battle rhythm. It should also assess mobility requirements for counter-WMD and WMD-E operations, including options to reduce the time required to deploy capabilities into theater and the desirability of prepositioning WMD-E TF units, as well as early deployment of long-dwell ISR assets or unmanned combat air vehicles.

In addition, the Army needs to develop alternative concepts of operations for conducting WMD-E operations within a joint campaign. Furthermore, it should assess the number of simultaneous WMD-E TFs that could be supported by existing and planned technical units. Finally, the Army should decide upon roles, missions, component mixes, and training requirements for countering WMD—to ensure that a sufficient number of trained and ready TFs are available to perform this important national strategic mission.

Although the strategy-policy gap in countering WMD has only recently become apparent, the consequences of continued unpreparedness in the various mission areas involved—in particular, WMD-E—are potentially grave. Urgent action is needed to better assess and close this gap. To this end, this report's key findings, summarized below, aim to prompt such action:

- Countering the proliferation of WMD—especially nuclear weapons—to violent extremists is a top national priority and should be resourced like one.
- The missions involved are of such size and complexity that they require the full scope and scale of joint forces—not just specialized technical capabilities.
- However, counter-WMD missions have not been given priority for defense resources; hence, the United States may lack both the capabilities and the capacity required to conduct WMD-E operations in a collapsed state.
- Policymakers need to answer a key question: What is the number and size of WMD sites the United States should be prepared to assault, secure, and neutralize simultaneously?

The Army cannot redress gaps in countering WMD on its own or by itself—the need for joint, even combined, forces is paramount and clear—but neither can these national strategy–resource policy gaps be closed sufficiently, much less fully, without the Army, whose force capacity and capabilities—properly resourced—are essential to the task.

A final thought: In the worst cases (e.g., Hostile/High Threat with a large number of targeted sites), the numbers of troops required for WMD-E would be so large as to exceed current—or even significantly increased—Army force structure limits, consuming more than the 32–33 BCTs currently planned for the AC. Such high numbers begin to make countering WMD with WMD-E operations sound like “mission impossible,” even with a larger force structure. Why bother, one might ask? Because, we submit, there is at least one countervailing argument and it is this: in the end, relatively few (nuclear) sites contain the priority targets that really need to be eliminated—in which case the mission becomes more *doable*, not less urgent. As a result, it is not necessarily a hopeless task to plan on performing WMD-E missions and increasing force structure to make such planning possible. The worst case is not the only case—perhaps not even the most likely one—and prudent planning, which should draw upon parametric analyses like those presented in this report, takes into account the need to set priorities and accept risk.

Selected National Security Documents and Joint and Service Doctrine

In 2002, the White House issued both its first *National Security Strategy* and the *National Strategy to Combat Weapons of Mass Destruction*. The 2002 *National Security Strategy* states that:

The gravest danger to freedom lies at the crossroads of radicalism and technology. When the spread of chemical and biological and nuclear weapons, along with ballistic missile technology—when that occurs, even weak states and small groups could attain a catastrophic power to strike great nations. Our enemies have declared this very intention, and have been caught seeking these terrible weapons. They want the capability to blackmail us, or to harm us, or to harm our friends—and we will oppose them with all our power.¹

The *National Strategy to Combat Weapons of Mass Destruction* further states that:

Weapons of mass destruction (WMD)—nuclear, biological, and chemical—in the possession of hostile states and terrorists represent one of the greatest security challenges facing the United States. We must pursue a comprehensive strategy to counter this threat in all of its dimensions . . .

Weapons of mass destruction could enable adversaries to inflict massive harm on the United States, our military forces at home and abroad, and our friends and allies. Some states, including several that have supported and continue to support terrorism, already possess WMD and are seeking even greater capabilities, as tools of coercion and intimidation. For them, these are not weapons of last resort, but militarily useful weapons of choice intended to overcome our nation's advantages in conventional forces and to deter us from responding to aggression against our friends and allies in regions of vital interest.

¹ The White House, 2002a.

In addition, terrorist groups are seeking to acquire WMD with the stated purpose of killing large numbers of our people and those of friends and allies—without compunction and without warning . . .

We must accord the highest priority to the protection of the United States, our forces, and our friends and allies from the existing and growing WMD threat . . .²

It is therefore critical that the U.S. military and appropriate civilian agencies be prepared to deter and defend against the full range of possible WMD employment scenarios. We will ensure that all needed capabilities to combat WMD are fully integrated into the emerging defense transformation plan and into our homeland security posture. Counterproliferation will also be fully integrated into the basic doctrine, training, and equipping of all forces, in order to ensure that they can sustain operations to decisively defeat WMD-armed adversaries.³

The 2010 *National Security Strategy* builds upon the threat posed by WMD, and especially nuclear weapons, stating that:⁴

This Administration has no greater responsibility than the safety and security of the American people. And there is no greater threat to the American people than weapons of mass destruction, particularly the danger posed by the pursuit of nuclear weapons by violent extremists and their proliferation to additional states.

And:

The American people face no greater or more urgent danger than a terrorist attack with a nuclear weapon. And international peace and security is threatened by proliferation that could lead to a nuclear exchange. Indeed, since the end of the Cold War, the risk of a nuclear attack has increased. Excessive Cold War stockpiles remain. More nations have acquired nuclear weapons. Testing has continued. Black markets trade in nuclear secrets and materials. Terrorists are determined to buy, build, or steal a nuclear weapon. Our efforts to contain these dangers are centered in a global nonproliferation regime that has frayed as more people and nations break the rules.

The February 2010 QDR stated:

The proliferation of weapons of mass destruction (WMD) continues to undermine global security, further complicating efforts to sustain peace and prevent harmful arms races. The instability or collapse of a WMD-armed state is among our

² The White House, 2002b.

³ The White House, 2002b, p. 2.

⁴ The White House, 2010, pp. 4, 23.

most troubling concerns. Such an occurrence could lead to a rapid proliferation of WMD material, weapons, and technology, and could quickly become a global crisis posing a direct physical threat to the United States and all other nations . . .

The potential spread of weapons of mass destruction poses a grave threat. . . .

Preventing the proliferation and use of such weapons is therefore a top national priority for which many federal agencies have important responsibilities.⁵

Official statements have even suggested that the countering WMD mission set has eclipsed the traditional nuclear deterrence and warfighting mission. For example, the April 2010 NPRR placed the prevention of nuclear terrorism and proliferation at the top of the U.S. policy agenda,⁶ and in testimony in January 2012, General Kehler, commander of U.S. Strategic Command, testified that “the threat posed by WMD in the hands of violent extremists transcends all of USSTRATCOM’s priorities and encompasses every geographic area of responsibility (AOR).”⁷

The January 2012 DSG adds that:

The proliferation of nuclear, biological, and chemical weapons technology has the potential to magnify the threats posed by regional state actors, giving them more freedom of action to challenge U.S. interests. Terrorist access to even simple nuclear devices poses the prospect of devastating consequences for the United States. Accordingly, *the Department of Defense will continue to enhance its capabilities, acting with an array of domestic and foreign partners, to conduct effective operations to counter the proliferation of WMD.* (Emphasis in original)⁸

Together, the *National Strategy to Combat WMD* and the *National Military Strategy to Combat WMD* describe three “pillars,” eight military “mission areas,” the strategic goal, and nine end states for combating WMD as shown in Figure 2.1. Among the pillars, counterproliferation comprises “the full range of operational capabilities to counter the threat and use of WMD by states and terrorists.”⁹ Five of the mission areas feature military forces in a leading role, including:

- *WMD Offensive Operations* comprises the “detection, identification, disruption, and/or destruction of an adversary’s WMD assets, means of delivery, associated

⁵ DoD, 2010a, pp. iv, 23.

⁶ DoD, 2010b, p. i.

⁷ Kehler, 2012.

⁸ DoD, 2012b, p. 3.

⁹ The White House, 2002b, p. 2.

facilities, and other high-value targets.”¹⁰ This includes raids, strikes, and other actions to prevent, pre-empt, or defeat the employment of WMD.

- *WMD-Elimination* includes operations to “systematically locate, characterize, secure, disable, and/or destroy a State or non-State actor’s WMD programs and related capabilities in hostile or uncertain environments.” Notably, the strategy states that DoD “must develop, institutionalize, and exercise a joint capability to eliminate WMD in uncertain environments,” including integrating this mission into doctrine, organization, and training and that commanders should be “prepared to conduct elimination activities from the initiation of operations” until they can be transferred to another agency.
- *WMD Interdiction Operations* comprise tracking, intercepting, searching for, and seizing WMD and related components in transit. This includes terrorist, criminal, and covert movements of WMD, materials, components, and technical experts.
- *WMD Active and Passive Defense* includes active measures to defeat an attack and passive measures to mitigate the effects of a successful attack. Active defenses include air and missile defense and defenses against unconventionally delivered WMD. Passive defenses seek to minimize or negate vulnerability and the effects of WMD use.

The overarching strategic goal is to ensure that states and nonstate actors cannot coerce or attack the United States, its forces, or its allies, partners, and interests with WMD. The degree to which this goal has been attained would, in principle, be measured by a set of end-states and standards. We discuss these measures in Chapter Three.

The February 2010 QDR makes it clear that the scenario combinations that were used to assess the planned force’s capability to execute the strategy at moderate risk did not include a counter-WMD scenario involving WMD-E operations as part of a larger joint campaign that included unified land operations.¹¹ Without such campaign-level assessments, it will be difficult to understand the joint force requirements of such missions, or the timelines that may be required to effectively secure and prevent the proliferation or use of WMD.¹²

The January 2012 DSG identifies ten primary missions of the U.S. military, highlighting the following four as those that drive requirements for the development of military capacity:

1. counterterrorism and irregular warfare
2. deter and defeat aggression

¹⁰ Chairman, Joint Chiefs of Staff, 2006, p. 8.

¹¹ The scenario combinations that were tested are detailed on pp. 42–43 of the 2010 QDR. DoD provides a rich illustration of the ways that WMD missions might be integrated into different types of campaigns. See DoD, 2009, Chapters IV and V.

¹² Indeed, it is quite plausible that the time-sensitivity and urgency of counter-WMD operations is much higher than that for many missions that are currently being used to estimate force requirements.

3. maintain a safe, secure, and effective nuclear deterrent
4. defend the homeland and provide support to civil authorities.

Missions shaping the future joint force, but not driving capacity requirements include:

5. project power despite anti-access/area denial challenges
6. counter-WMD
7. operate effectively in cyberspace and space
8. provide a stabilizing presence
9. conduct stability and counterinsurgency operations
10. conduct humanitarian, disaster relief, and other operations.

Thus, although the DSG includes countering WMD among the ten primary missions of the U.S. military, it does not include this mission among those that drive military capacity—meaning that it is not accorded a priority that is sufficiently high to require the services to enhance capacity and force structure for its successful accomplishment.

For its part, DoD's *Defense Budget Priorities and Choices Fiscal Year 2014* includes a single mention of WMD as it relates to SOFs' counterproliferation mission set,¹³ but does not call out the counter-WMD mission area as a priority for budget resources or capability enhancement.

DoD has promoted a number of initiatives that are aimed at enhancing capabilities for combating WMD. The February 2010 QDR, for example, identified six initiatives to prevent proliferation and counter weapons of mass destruction:

1. Establish a standing Joint TF Elimination Headquarters.
2. Research countermeasures and defenses to nontraditional agents.
3. Enhance nuclear forensics.
4. Secure vulnerable nuclear materials.
5. Expand the biological threat reduction program.
6. Develop new verification technologies.¹⁴

Of these, the creation of a standing joint force headquarters for elimination operations is arguably the most consequential from an operational and force structure perspective.

The May 2011 biennial report of the Counterproliferation Program Review Committee (CPRC) provided an assessment of progress in meeting the goals associated with

¹³ DoD, 2013a, p. 29.

¹⁴ DoD, 2010a, pp. 35–37.

nine Areas for Capability Enhancement (ACEs),¹⁵ including two that arguably involve the strongest potential for the employment of ground forces: Offensive Operations and Elimination Operations:

- *Offensive Operations* are kinetic (both conventional and nuclear) and/or nonkinetic options to deter, neutralize, or defeat a WMD threat or subsequent use of WMD. None of the ongoing efforts detailed had much relevance to potential force structure requirements associated with WMD offensive operations.
- *Elimination Operations* are operations to systematically locate, characterize, secure, disable, and/or destroy a state or nonstate actor's WMD programs and related capabilities in uncertain or hostile environments. Among the notable accomplishments detailed were: "Creation of the Standing Joint Force Headquarters-Elimination," and "Expansion of 20th Support Command (CBRNE) capabilities for C2 for WMD elimination missions. Unit reached Full Operational Capability (FOC) in October 2009." The remaining four accomplishments had little or no relevance to force structure requirements for the WMD elimination mission.

In both cases, however, the CPRC report recommended additional action "[w]ithin the DoD [Joint Capabilities Integration Development System] process, [to] develop solutions for WMD [elimination, offensive operations] gaps/shortfalls."

Moreover, as described in the CPRC's report, one of the goals is to "[p]rovide operational constructs, *force structure*, and WMD render-safe skills and capabilities, to include reachback" [emphasis added]. However, little or nothing was actually said about the potential force structure requirements associated with WMD-E and offensive operations, and no capabilities-based assessment of the potential gaps related to ground force capabilities for WMD elimination and offensive operations appears to have been done.

DoD's most recent strategic management and performance assessment report restates DoD's commitment to enhancing capabilities for counterproliferation and describes the range of activities as follows:¹⁶

DoD conducts a range of activities in partnership with other elements of the U.S. Government and international allies and partners aimed at preventing the proliferation and use of nuclear, biological, and chemical weapons. These activities include strengthening non-proliferation regimes, building partner capacity to counter

¹⁵ The nine ACEs identified in the CPRC report were (1) interdiction, (2) elimination, (3) threat reduction cooperation, (4) passive defense, (5) security cooperation and partner activities, (6) offensive operations, (7) active defense, (8) WMD consequence management, and (9) intelligence.

¹⁶ The report states: "Accordingly, DoD will continue to enhance its capabilities and to conduct effective operations to counter the proliferation of weapons of mass destruction (WMD), acting with an array of domestic and foreign partners." See DoD, 2013a, p. 2-2.

WMD, Cooperative Threat Reduction (CTR) initiatives, and planning and operations to locate, monitor, track, intercept, interdict, secure, and dispose of WMD and WMD-related components and the means to make them. They also include participation in an active whole-of-government effort to frustrate the ambitions of nations and non-state actors bent on possessing WMD. DoD will continue to invest in capabilities to predict, detect, protect against, and respond to WMD proliferation and use, should preventive measures fail. Key enhancements associated with this mission area include: maintaining the Chemical Biological Incident Response Force (CBIRF); continuing efforts to expand the geographic reach of the CTR program; and providing additional funds for ground-based prompt nuclear forensics diagnostics systems.¹⁷

The performance assessment framework includes a strategic goal of “Prepare to Defeat Adversaries and Succeed in a Wide Range of Contingencies” that accounts for nine (13 percent) of DoD’s fiscal year 2012 performance results. The strategic goal is further broken into five strategic objectives, as follows:

- 3.1-1F2A: Maintain a safe, secure, and effective nuclear arsenal to deter attack on the U.S. and on our allies and partners.
- 3.2-1F2B: Improve the responsiveness and flexibility of consequence management response forces.
- 3.3-1F2C: Enhance capacity to locate, secure, or neutralize weapons of mass destruction, key materials, and related facilities.
- 3.4-1X1: Expand capacity to succeed against adversary states armed with anti-access capabilities and/or nuclear weapons and improve capabilities to conduct effective operations in cyberspace and space.
- 3.5-2D: Maintain a strong technical foundation within the Department’s Science and Technology (S&T) program.

Of these, the strategic objective most relevant to the WMD-E operations that ground forces might need to conduct is 3.3-1F2C, which has the following two performance measures:

- 3.2.1-1F2C: Cumulative percent of treaty-declared category 1 CWs destroyed
- 3.2.2-1F2C: Cumulative number of labs working with dangerous pathogens at risk for exploitation.¹⁸

Thus, the report highlights the elimination of U.S. CW stocks and the enhancement of DoD laboratories for BW research as DoD’s principal WMD-E capacity

¹⁷ See DoD, 2013a, p. 2-4.

¹⁸ DoD, 2013a, pp. 8-19 and 8-21.

enhancement activity over the preceding year.¹⁹ While no doubt important,²⁰ such activities are not as relevant as they might be to the challenges of WMD-E in an operational environment such as disarming a nuclear- and chemical-armed DPRK or a chemical-armed Syria: They do not directly enhance the WMD-E capabilities or capacity of forces that would be conducting the maneuver-isolate-seize-eliminate tasks of WMD-E missions as the core element of a large joint or combined operation.

Counter-WMD Doctrine

The counter-WMD mission is broad—comprising a “range of activities aimed at preventing the proliferation and use of nuclear, biological, and chemical weapons”—and including the Cooperative Threat Reduction Program, and the Proliferation Security Initiative launched in 2003 as a global effort to locate, monitor, track, interdict, and secure WMD and related components.²¹ Also included are “an active whole-of-government effort to frustrate the ambitions of nations bent on developing WMD,” including Iran.²²

Although not accorded the status of driving force structure capacity, the U.S. government, including DoD, have engaged in significant efforts to elaborate the ways by which WMD will be countered. As described in Chapter One, there are a number of strategies, doctrines, TTP, and other documents that guide U.S. government in planning and capability development efforts for combating WMD (see Table A.1), and we will discuss several of the most important of these documents in this section.

Most of the doctrinal documents in Table A.1 were written since OIF I (operations in Iraq in 2003) and reflect (to varying degrees) lessons learned from the WMD-E operations conducted in Iraq in the spring and summer of 2003; the intent of most of these documents was to fill the various doctrinal gaps that existed at that time.

Before describing what is included in current counter-WMD doctrinal texts, and what remains to be developed, it is important to establish in the reader’s mind the purposes of military doctrine. As defined in DoD’s *Dictionary of Military and Associated Terms*, doctrine consists of “[f]undamental principles by which the military forces or elements thereof guide their actions in support of national objectives. It is authoritative but requires judgment in application.” Thus, doctrine provides concepts, principles, and guidance for more detailed planning for specific operations, but is not, and cannot be, a substitute for detailed campaign planning.

¹⁹ Strategic Objective 3.2.1F2C, in DoD, 2013a, pp. 8–21.

²⁰ For example, such activities offer some value in enhancing the capabilities of civilian technical personnel in CW destruction, and the analysis of biothreats.

²¹ The Proliferation Security Initiative aims to “establish a more coordinated and effective basis through which to impede and stop shipments of WMD, delivery systems, and related materials flowing to and from states and non-state actors of proliferation concern.” The White House, 2003.

²² DoD, 2012b, p. 5.

Table A.1
Strategy, Doctrine, and Other Counter-WMD Related Guidance

STRATEGY DOCUMENTS
<i>National Security Strategy (NSS)</i> , White House, 2010
<i>National Defense Strategy (NDS)</i> , DoD, June 2008
<i>National Military Strategy (NMS)</i> , Chairman, Joint Chiefs of Staff, Washington, D.C., February 8, 2011
<i>National Strategy to Combat WMD (NScounter-WMD)</i> , White House, 2002b
<i>National Military Strategy for Combating WMD (NMScounter-WMD)</i> , Chairman, Joint Chiefs of Staff, 2006
<i>Quadrennial Defense Review (QDR)</i> , DoD, 2010a
<i>Defense Strategic Guidance (DSG)</i> , DoD, 2012b
<i>Defense Budget Priorities and Choices Fiscal Year 2014</i> , DoD, 2013a
DoD Strategic Management and Performance Assessment Report, DoD, 2013a
JOINT OPERATIONAL CONCEPT/CAPABILITY DEVELOPMENT
<i>Joint Integrating Concept for Combating Weapons of Mass Destruction (JIC)</i> , DoD, Washington, D.C. December 2007
<i>The United States Army Concept Capability Plan for Combating Weapons of Mass Destruction for the Modular Force 2015-2024</i> , U.S. Army, Version 1.0, TRADOC Pamphlet 525-7-19, March 2009
JOINT DOCTRINE
<i>Operations (JP 3-0)</i> DoD, 2011c
<i>Combating Weapons of Mass Destruction (JP 3-40)</i> , DoD, 2009
ARMY/MULTISERVICE DOCTRINE
<i>Chemical, Biological, Radiological, Nuclear, and High Yield Explosives Operational Headquarters</i> , U.S. Army, Washington, D.C., FMI 3-90.10, January 2008
<i>Site Exploitation Operations</i> , U.S. Army, Washington, D.C., ATTP 3-90.15 (FM 3-90.15), July 2010b
<i>Multi-Service Tactics, Techniques, and Procedures for Weapons of Mass Destruction Elimination Operations</i> , U.S. Army, ATTP 3-11.23, December 2010d
<i>Multi-Service Tactics, Techniques, and Procedures for Chemical, Biological, Radiological, and Nuclear Aspects of Command and Control</i> , U.S. Army, ATTP 3-11.36, 2010a
<i>Multi-Service Doctrine for Chemical, Biological, Radiological, and Nuclear Operations</i> , U.S. Army, Washington, D.C., FM 3-11, July 2011b
<i>Multi-Service Tactics, Techniques, and Procedures for Chemical, Biological, Radiological, and Nuclear Reconnaissance and Surveillance</i> , U.S. Army, Washington, D.C., ATTP 3-11.37, December 2010c

The doctrinal documents listed in Table A.1 detail many of the general themes needed to inform campaign planners about WMD-E and other counter-WMD operations. What they do not provide are detailed campaign plans for how a JTF might locate, identify, seize, secure, and render safe WMD in a specific operational scenario: that is the responsibility of the JFC and his campaign planners: Campaign plans must be specifically developed with a given mission, enemy, terrain, and other operational factors in mind—with branches and sequels to cope with remaining uncertainties. Doctrine cannot anticipate or foresee the innumerable details that need to be considered in campaign planning, but it provides the guidelines and principles for considering these details.

To begin our analysis of relevant doctrine, JP 3-0 is the joint community's key-stone operational doctrinal publication and is intended to provide guidance for joint activities across the range of military operations. It is the core of joint warfighting doctrine and establishes the framework for the ability of U.S. forces to operate as a joint team.²³ JP 3-0 identifies combating WMD as a military operation for which joint forces can be designed, organized, equipped, and trained to execute.²⁴ JP 3-0 focuses on higher-level C2 concepts, and broader principles of campaign design, and not on the details of conducting specific classes of military operations. Instead, it points the reader to the appropriate doctrine regarding each type of military operation;²⁵ JP 3-0 identifies JP 3-40 as the source for joint doctrinal guidance on combating WMD operations.

JP 3-40 provides the fundamental principles and guidance for joint counter-WMD operations. This includes prescribing joint doctrine for counter-WMD operations and guidance for the exercise of authority by combatant and other JFCs as well as military guidance for the Armed Forces in preparing appropriate plans.²⁶

Within the military, the Chairman of the Joint Chiefs of Staff is the principal military advisor to the President, the National Security Council, and the Secretary of Defense regarding counter-WMD operations, and is responsible for apportioning counter-WMD resources for the planning and execution of the counter-WMD mission. The Chairman is also responsible for assisting with interagency support for counter-WMD operations, assisting in the planning and exercising of counter-WMD activities within the interagency process, and coordinating and providing intelligence support to the CCDRs for target identification and prioritization.²⁷

The geographic combatant commanders have the task of planning and executing counter-WMD operations within their respective AORs. They are to develop regional counter-WMD plans and incorporate counter-WMD operations into their other plans. CCDRs' counter-WMD planning responsibilities includes preparing strategic estimates, priorities, and joint operations plans. This includes coordinating with the Office of the Secretary of Defense and Joint Staff planning for the transition of counter-WMD operations to or from the U.S. military from or to other multinational forces

²³ DoD, 2011c.

²⁴ The other missions specifically identified are stability operations, civil support, foreign humanitarian assistance, recovery, noncombatant evacuation, peace operations, CBRN consequence management, foreign internal defense, counterdrug operations, combating terrorism, counterinsurgency, and homeland defense. DoD, 2011c, p. I-15.

²⁵ See, for example, Joint Chiefs of Staff, *Counterinsurgency*, JP 3-24, November 2013, regarding joint doctrine for counterinsurgency operations.

²⁶ DoD, 2009, p. i.

²⁷ DoD, 2009, p. III-1.

or nation-states.²⁸ The geographic combatant commanders plan and execute counter-WMD operations in accordance with their responsibilities and as directed by the Secretary of Defense. JP 3-40 notes that during large-scale contingency operations, it may be necessary to establish a functional JTF for counter-WMD operations. Such JTFs could focus on executing a single counter-WMD mission, such as WMD elimination, or it could consolidate several counter-WMD operations or functions into a single JTF.²⁹ Currently, the 20th Support Command is tasked with providing the nucleus for such a counter-WMD JTF.³⁰

Joint counter-WMD actions and activities can occur in permissive, uncertain, and hostile environments, and are neither planned nor executed in isolation: They need to be integrated into all types of operations across the range of military operations.³¹ They can be executed either with counter-WMD-specific forces or through the unique application of conventional forces. The JFC thus leverages necessary capabilities from all six joint warfighting functions during a campaign to achieve the desired counter-WMD effects and objectives³² (see Figure A.1).

JP 3-40 is a detailed description of a concept of operation for WMD-E operations conducted under a JTF-E that might command and control WMD-E forces as part of a larger joint operation.³³ It remains, however, the responsibility of the geographic combatant commander to plan and, if necessary, execute WMD-E operations. This includes coordinating development of a WMD-E target list with the intelligence community and providing security and logistics support to forces conducting WMD-E operations.³⁴

WMD-E operations consist of four principal operational-level tasks: isolation, exploitation, destruction, and monitoring and redirection. WMD-E operations may be conducted as part of any operation type (e.g., major combat, stability, humanitarian assistance) and during any phase of a campaign, or as an independent operation. That is, the four steps of WMD-E discussed later may be performed simultaneously at various geographically separate sites. JTF-E activities will require logistics and security to be drawn from resources possibly allocated to ongoing operations. Most non-DoD agencies require a secure environment to support WMD-E missions. JTF planners

²⁸ DoD, 2009, pp. III-1to III-2.

²⁹ DoD, 2009, pp. III-6 to III-10.

³⁰ See U.S. Army, 2011a.

³¹ DoD, 2009, pp. IV-4 to IV-5.

³² DoD, 2009, p. IV-6.

³³ DoD, 2009, Appendix A.

³⁴ DoD, 2009, pp. A-13 to A-14.

Figure A.1
Integration of Combating WMD in Joint Operations

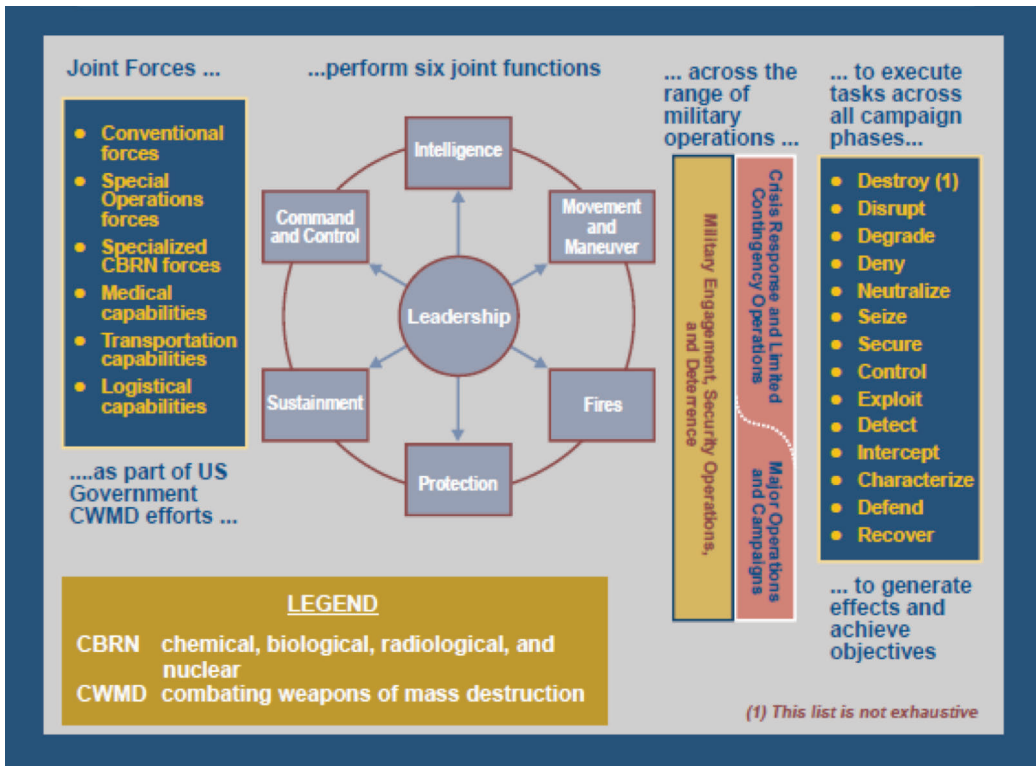

SOURCE: DoD, 2009, p. IV-7.

RAND RR541-A.1

should consider the requirements for additional security forces when considering site security for these non-DoD elements.³⁵

Figure A.2 illustrates the joint concept of operation for the WMD-E mission from JP 3-40 and lists some of the specialized joint capabilities required to support the JFC operational concept. As shown in the figure, the overall operation is conducted under a supported JFC, who commands the overall joint operation, while WMD-E operations, including survey and reconnaissance, exploitation, security, disablement, and WMD sample and material technical escort operations, are conducted under a JTF-E headquarters that is subordinate to the JFC. Please note that the JTF-E will include some maneuver forces to seize and secure sites.

Though these maneuver forces are not specifically listed in the “Joint Capabilities,” they are depicted as tanks in Figure A.2, as “Maneuver Units” in Figure A.3, and included in WMD-E TFs described in Chapter Four.)

³⁵ DoD, 2009, p. A-1.

Figure A.2
WMD-E Concept of Operations

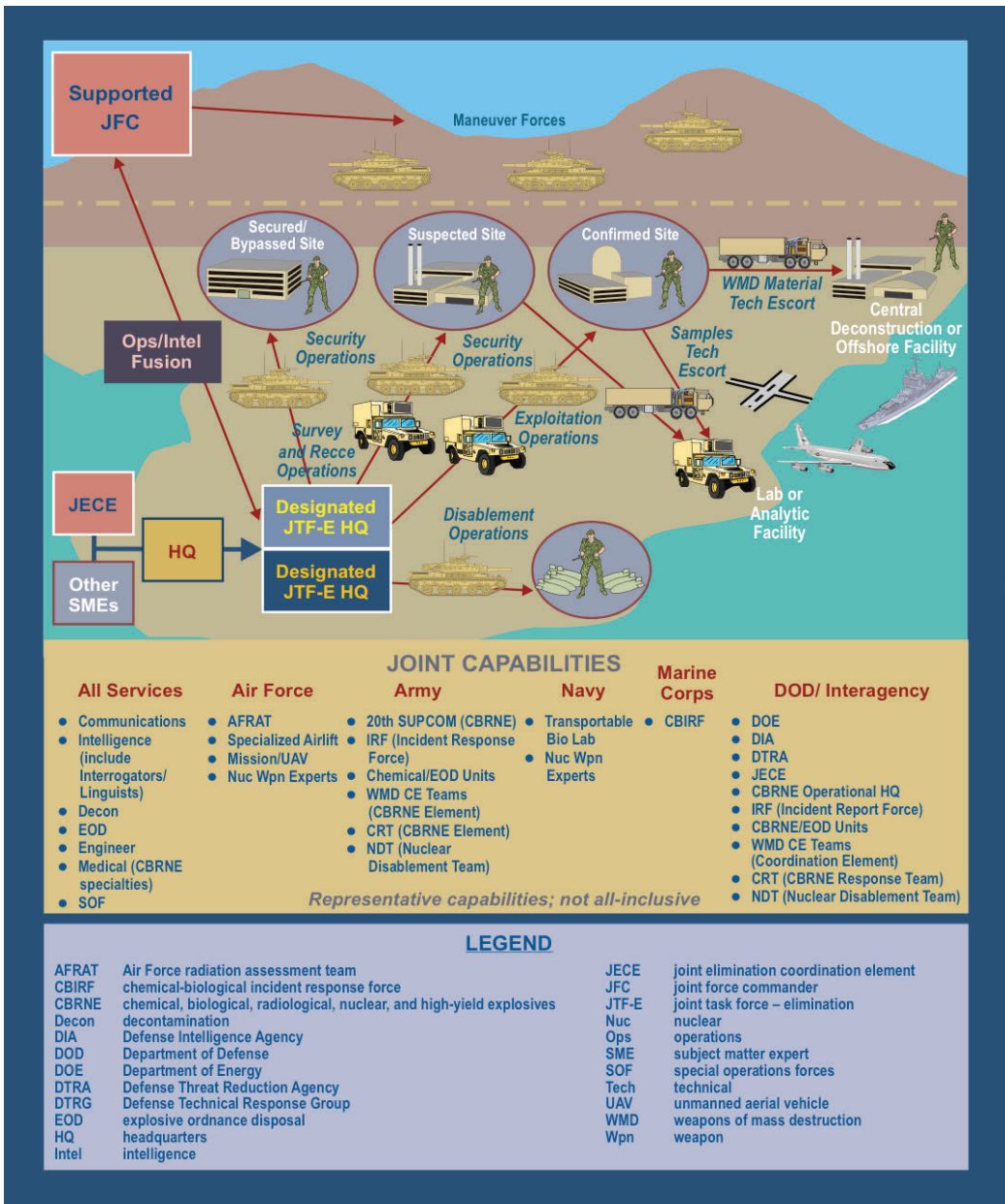

SOURCE: DoD, 2009, p. A-3.

RAND RR541-A.2

Figure A.3
WMD-E Campaign Construct

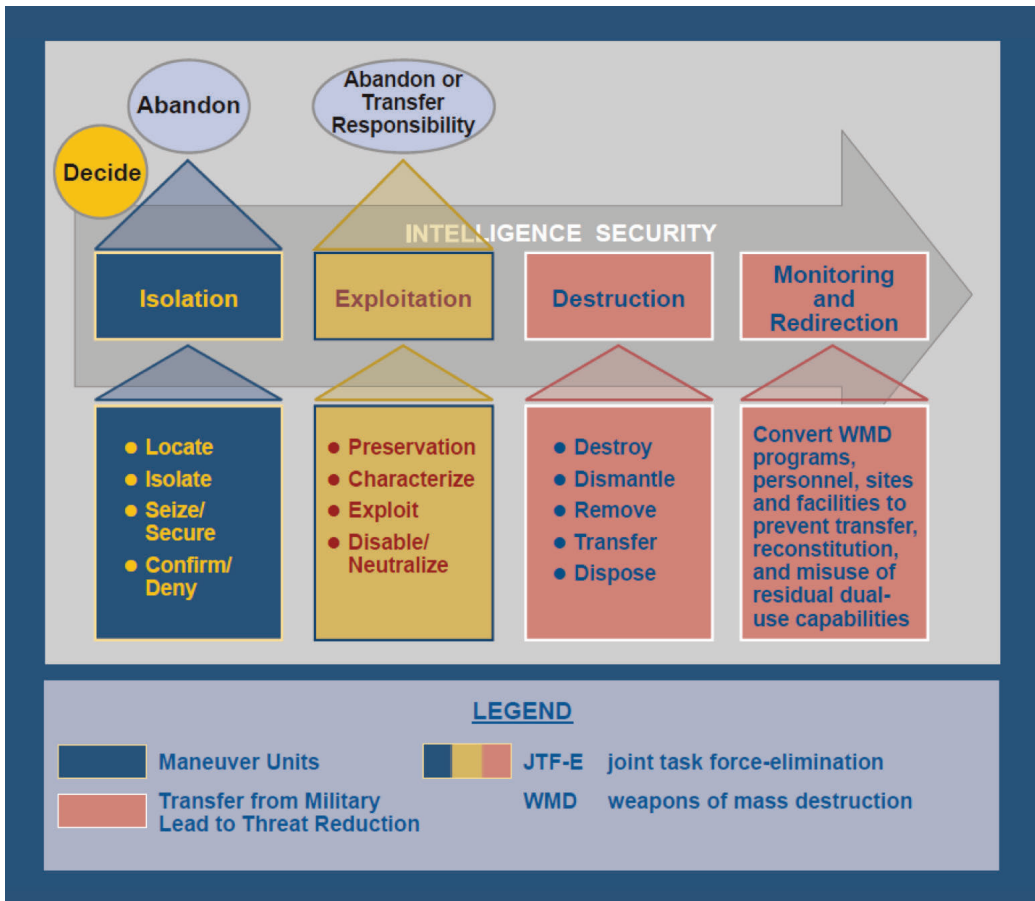

SOURCE: DoD, 2009, p. A-2.

RAND RR541-A.3

As noted earlier, JP 3-40 provides an operational construct for WMD-E operations consisting of four principal tasks: isolation, exploitation, destruction, and monitoring and redirection. This construct is intended to provide an operational approach and guidance to JFCs and operational planners in leveraging capabilities from the six warfighting functions across the range of military operations and campaign phases. The joint operational concept for WMD-E operations is illustrated in Figure A.3.

The first two phases of this construct are the most relevant for military planners because they most directly involve maneuver and specialized military forces; ideally, after the exploitation task is completed, primary responsibility for the WMD-E mission will be transferred to civilian or other technical agencies.

The *isolation* task focuses on physically securing suspected WMD sites, equipment, and material to prevent possible proliferation, pilfering, or destruction of evi-

dence; to detain personnel; and to prevent the dispersion, contamination or collateral effects of released WMD material or agents. It consists of four principal subtasks: locate, isolate, seize or secure, and confirm or deny.³⁶

- The *locate* subtask includes continuously collecting actionable intelligence about the adversary's WMD program from the strategic to tactical level. As new intelligence is acquired, it expands, redirects, and reprioritizes intelligence collection activities. During the conduct of joint military operations, maneuver and support units act upon this intelligence to physically locate WMD sites, material, and personnel, or they may encounter them inadvertently. Planning for WMD-E operations should provide a methodology for prioritizing targets or sites for exploitation. All-source ISR is critical for the execution of this subtask and to counter adversary camouflage, concealment, and deception efforts.³⁷
- The *isolate* subtask consists of actions taken to physically isolate a located, known, or suspected WMD site. Isolation is accomplished by maneuver forces. During planning, consideration needs to be given to having additional security forces available, in case unanticipated sites or facilities are encountered by maneuver units.³⁸
- The *seize or secure* subtask focuses on the possibility that lethal or nonlethal offensive operations may be required to reduce or neutralize a site's potential active and passive security measures. WMD-E operations planning thus needs to address how to detect, assess, and defeat site defenses; establish and maintain secure control of WMD sites until the absence of CBRN material is confirmed, or such material has been removed, eliminated, or neutralized; and the transfer responsibility of the facility and its security to another agency can be executed. Depending on the extent of the site's defenses and its size or type, it may be necessary to coordinate for additional assets to help seize or secure the facility. WMD-E planning must also take into account the effects of the need to provide security to a large number of sites and the transition of the security mission to follow-on forces or organizations.³⁹
- The *confirm or deny* subtask focuses on identifying the presence of absence of WMD at the site by using the seizing unit's organic equipment and predeployment training. If the presence of WMD cannot be confirmed, additional low-density specialized CBRN survey and reconnaissance assets may need to be deployed.⁴⁰

³⁶ DoD, 2009, p. A-1.

³⁷ DoD, 2009, p. A-3.

³⁸ DoD, 2009, pp. A-3 to A-4.

³⁹ DoD, 2009, p. A-4.

⁴⁰ DoD, 2009, p. A-4.

The *exploitation* task focuses on gaining an understanding of the adversary's WMD program and capabilities and possible connections to proliferation networks, identifying future targets, and providing information to support force protection from potential immediate WMD threats. Exploitation generally requires specialized CBRN, intelligence, and technical augmentation forces capable of conducting sensitive site exploitation operations, which are generally found in the services' combat support agencies or in other government agencies, such as the Department of Energy or the Department of State. In order to operate, these specialized forces may require the establishment and maintenance of a locally permissive environment. The exploitation task has four subtasks: preserve, characterize, exploit, and disable/neutralize.⁴¹

- The *preserve* subtask focuses on providing tactical security at a site and safeguarding known or suspected WMD materials until specialized forces can be deployed. These long-term security requirements can be quite large, and WMD-E planning should include additional security forces to be assigned to the WMD-E mission. The number of these additional security forces will depend on the number and size of the sites a unit is to locate and exploit.⁴²
- The *characterize* subtask involves the exploitation of the site by the specialized technical forces in accordance with the JFC's critical information requirements. It involves detailed assessments of weapons, materials, agents, equipment, and infrastructure that may require hours or days to complete.⁴³
- The *exploit* subtask involves the initial intelligence exploitation of program experts, documents, other media, weapons, materials, agents, delivery systems, and related processes and facilities located at the site. This process can lead to the prioritization of sites or the identification of additional sites or experts for exploitation. This task requires the combined efforts of multiple DoD and other government agencies, as well as the use of technical WMD and specialized intelligence analysts.⁴⁴
- The *disable/neutralize* subtask involves the exploitation forces rendering harmless or destroying weapons and other materials that pose an immediate danger to U.S. forces or civilian populations. It is a force protection measure, rather than a systemic destruction effort.⁴⁵

The *destruction* task focuses on the destruction, dismantling, removal, transfer, or other methods of eliminating an adversary's WMD materials, weapons, equipment, and infrastructure. While it is preferable that this task be conducted in a permissive

⁴¹ DoD, 2009, p. A-4.

⁴² DoD, 2009, pp. A-4 to A-5.

⁴³ DoD, 2009, p. A-5.

⁴⁴ DoD, 2009, p. A-5.

⁴⁵ DoD, 2009, p. A-5.

environment, the JFC must plan for and be prepared to conduct such operations in a hostile or uncertain environment until conditions permit the transfer of the task to another agency.⁴⁶ The *monitoring and redirection* task is generally conducted by inter-agency or intergovernmental organizations and focuses on continuously monitoring the former WMD program to ensure that it is not reconstituted, as well as converting dual-use material, equipment, and personnel to peaceful purposes.⁴⁷ It should be noted that during WMD-E operations, the above four tasks and their related subtasks may be conducted sequentially or simultaneously, or they may be omitted, depending upon the specific details and requirements of the operations.

The Army field manual titled *Chemical, Biological, Radiological, Nuclear and High Yield Explosives Operational Headquarters* provides additional details on WMD-E operations, and provides doctrinal guidance for the Army's CBRN operational headquarters, which has the mission of deploying and conducting operations in support of CCDRs or other government agencies engaged in WMD-E operations.⁴⁸ Additional operational- and tactical-level doctrine regarding WMD-E operations can be found in the restricted distribution multiservice document titled *Multi-Service Tactics, Techniques, and Procedures for Weapons of Mass Destruction Elimination Operations*.⁴⁹ That document describes the use of augmented combat forces (battalions and companies) to conduct the first two WMD-E tasks in a WMD-E operation.

Campaign planning for WMD-E operations is discussed in Army FMI 3-90.10, *Chemical, Biological, Radiological, Nuclear, and High Yield Explosives Operational Headquarters*, which states that successful WMD-E operations are the result of detailed planning, and that CCDRs should integrate WMD-E missions and WMD-E operations considerations into all phases of the joint planning process, from Phase 0 to Phase V.⁵⁰

To address specific counter-WMD missions, Army FMI 3-90.10 defines the mission of the CBRNE operational headquarters as supporting the commander of a larger, probably joint, operation:

The mission of the CBRNE operational headquarters is to deploy and conduct operations in support of combatant commanders (CCDRs) or other government agencies (OGAs) to counter CBRNE and WMD threats in support of national combating WMD objectives. Its core focus is on tactical, operational, and strategic exploitation and elimination operations. When directed . . . the CBRNE operational headquarters will provide the core elements, augmented with joint and

⁴⁶ DoD, 2009, pp. A-5 to A-6.

⁴⁷ DoD, 2009, pp. A-6 to A-7.

⁴⁸ U.S. Army, 2008.

⁴⁹ U.S. Army, 2010d.

⁵⁰ U.S. Army, 2008, pp. 1–9.

interagency enablers under a joint manning document, to form a joint task force headquarters for WMD elimination (JTF-E).

By design, this headquarters executes, tracks, and manages the response as well as provides C2 for Army and/or joint specialized CBRNE forces; executes WMD-E missions; and provides technical capabilities and CBRNE subject matter expertise to joint and Army commanders. Elements of this headquarters are designed to deploy and provide the core elements of a JTF headquarters in support of WMD-E or other similar missions. The inclusion of a Joint Elimination Coordination Element [predecessor of the SJFHQ-E] provided by USSTRATCOM is an essential element of such a JTF-headquarters.⁵¹

FMI 3-90.10 envisions that a CBRNE operational headquarters, or elements of the headquarters, would be attached to a higher-echelon organization (e.g., division, corps, joint force component command, JTF, JFC). Put another way, the operational- and tactical-level planning, integration of WMD-E capabilities with conventional or special operations forces engaged in WMD elimination and security missions, and the command and control of these hybrid forces are generally assumed to take place above the echelon of the CBRNE operational headquarters in a JTF or comparable operational-level C2 element.⁵²

Finally, *Multi-Service Tactics, Techniques, and Procedures for Weapons of Mass Destruction Elimination Operations* (ATTP 3-11.23) provides tactical-level guidance to forces conducting WMD-E operations, including detailed discussions of how to systematically locate, characterize, secure, control, disable, and transport WMD to a safe location. It also discusses conduct of WMD-E activities in uncertain and hostile environments, and provides a template for tailoring battalion- and company-sized combat forces into WMD-E TFs capable of seizing, securing, and exploiting potential WMD facilities. ATTP 3-11.23 also provides guidance on planning for “opportunity targets;” i.e., conducting WMD-E operations at sites that had not been previously known, and for which no planning had occurred.⁵³

In summary, joint and Army doctrine provides a joint commander with operational concepts that can help him plan and execute WMD-E operations as part of a larger joint campaign plan. It highlights the broader operational tasks required for WMD-E operations, as well as providing some of the necessary tactical and technical details. The WMD-E doctrine as it is currently structured, however, focuses on a country’s WMD program, and as a result tends to be somewhat installation-centric

⁵¹ U.S. Army, 2008, pp. viii, 2-1.

⁵² It is worth noting, however, that one of the missions of the CBRNE headquarters is to provide the core elements of a standalone JTF. See U.S. Army, 2011a, p. 2-2.

⁵³ See U.S. Army, *Multi-Service Tactics, Techniques, and Procedures for Weapons of Mass Destruction Elimination Operations*, Washington, D.C., ATTP 3-11.23, December 2010a. Not available to the general public.

while not directly addressing more tactical-oriented problems, such as how to handle CWs that may be encountered in operational caches on the battlefield. This problem is not readily handled by the WMD-E TF paradigm, and requires a careful integration of WMD-E tasks with the joint commander's plan for handling captured enemy ammunition as well as integration into the commander's broader campaign plans. In addition, combined-arms doctrine needs to more thoroughly explore how maneuver and supporting forces will be trained and organized to identify, consolidate, and/or eliminate captured WMD munitions. More generally, a complete discussion is needed of the intense WMD-E-oriented military intelligence tasks that will need to be conducted prior to and during the joint operation to increase the joint commander's ability to focus limited WMD-E assets on the highest-payoff facilities. Finally, doctrine also could be strengthened by more detailed discussion of transitions from WMD-E TFs to follow-on security and technical forces.

To conclude, we judge that, as with other joint and Army doctrine, existing doctrine for WMD-E provides the necessary intellectual framework for campaign design and planning, but as with all doctrine, existing doctrine will not provide answers to all of the problems that commanders may encounter; rather, it provides principles for arriving at solutions.

DPRK and Syrian WMD Sites

DPRK WMD Sites

It is difficult to determine the exact number of sites in North Korea that could require securing by a WMD-E TF due to the lack of reliable information on DPRK WMD programs.¹ For our illustrative analysis of WMD-E force requirements, we have used the NTI's dataset of WMD facilities because it draws upon multiple official, published, and press sources to provide what appears to be the most comprehensive and transparent open source list of actual, potential, and rumored facilities. As such, it undoubtedly misses some real facilities and includes facilities that in reality may not exist, or are not meaningfully associated with a WMD program. Table B.1 presents the results of our analysis of data from the NTI on DPRK WMD programs.²

As shown in Table B.2, we estimate that DPRK WMD and missile programs include approximately 141 sites identified as being of potential interest for WMD-E operations,³ of which 39 are associated with its nuclear program, 49 are associated with the ballistic missile program, 38 are related to its CW program, and 15 are related to its BW program.

Two issues complicate planning for the WMD-E mission. First, intelligence gaps will likely mean that there are critical facilities that remain unidentified or unlocated. Second, many weapons, particularly CWs, are likely to have been dispersed to numer-

¹ For instance, it is unclear how much of the DPRK's CW stockpile remains reliable. The DPRK relies on the importation of important precursors for some of its CW agents and recent economic problems and severe power and raw material shortages may have led to a halt or reduction in CW agent production. It is believed that the DPRK relies on unitary CW munitions that have a relative short shelf-life. NTI, undated-c.

² Our analysis of the NTI data on DPRK WMD and missile sites is described in detail in Appendix A.

³ Some aggregation of sites was done in cases where multiple facilities were co-located. For example, we have counted the 19 facilities identified by NTI as being located at the Yongbyon Nuclear Research Center as a single site, and we combined some facilities that were listed under two categories (for example, the Yongbyon Nuclear Research Center was listed under research and development and under fuel fabrication) or under two types (the Hamheung University of Chemical Industry was listed under both nuclear and chemical facilities). We arrived at the totals listed above after accounting for such dual entries. See NTI, undated-b. The accounting does not include potential tactical unit storage facilities, or the many potential tactical-level sites to which WMD weapons could be dispersed as tensions rise.

Table B.1
NTI Nuclear Facilities in North Korea

Critical Sites	Secondary Sites
Yongbyon Nuclear Research Center (1) <ul style="list-style-type: none"> 19 of NTI's nuclear facilities are located in the Yongbyon Nuclear Research Center 	Nuclear Research and Development (5) <ul style="list-style-type: none"> Kim Chaek University of Technology (Pyongyang) Kim Il Sung University (Pyongyang) Korea National Defense College (Kanggye) Laser Research Institute (Pyongyang) MGC-20 Cyclotron (Pyongyang)
Nuclear Enrichment Facilities (5) <ul style="list-style-type: none"> Taecheon Underground Suspected Nuclear Facility (Enrichment & Reprocessing) Bakcheon Underground Nuclear Facility Suspected Cheonmasan Uranium Enrichment Facility Hagap Underground Suspected Nuclear Facility Yeongjeo-ri Suspected Uranium Enrichment Facility 	Nuclear Education and Training (2) <ul style="list-style-type: none"> P'yŏngsŏng College of Science Hamheung University of Chemical Industry
Nuclear Storage Sites (1) <ul style="list-style-type: none"> Geumchang-ri Underground Facility 	Unfinished Nuclear Power Reactors (2) <ul style="list-style-type: none"> Geumho-Jigu Light Water Reactor Site (never built) Taecheon 200MWe Nuclear Reactor (never finished)
Nuclear Test Site (1) <ul style="list-style-type: none"> Punggye-ri Nuclear Test Facility 	<ul style="list-style-type: none"> •
Nuclear Weaponization Facilities (1) <ul style="list-style-type: none"> Yongdeok-dong High-Explosive Test Site 	<p>Facilities Associated with Uranium Mining and Processing</p>
	Nuclear Milling (5) <ul style="list-style-type: none"> Bakcheon Uranium Milling Facility Cheonmasan Uranium Milling Facility Korea International Chemical Joint Venture Company Kusong Uranium Milling Facility P'yŏngsan Uranium Milling Facility
	Nuclear Mines(16) <ul style="list-style-type: none"> Ch'ŏlsan Uranium Mine Haegumgang Uranium Deposit Hamhung Uranium Deposit Hwangsan January Industrial Mine Hyesan Uranium Mine Hungnam Uranium Mine Kujang Uranium Mine Kumchon Uranium Mine Musan Uranium Mine Najin Uranium Mine P'yŏngsan Uranium Mine Pakch'ŏn Uranium Mine Shinp'o Uranium Mine Sunch'ŏn Uranium Mine Sŏnbong Uranium Mine Wiwŏn Uranium Deposit

SOURCE: NTI, *North Korea Facilities: Nuclear*, web page, undated-c.

NOTE: Primary and secondary sites are drawn from NTI. Estimated weapons depots are based on RAND analysis.

ous tactical operational sites that are unlikely to be identified in advance, and that are not included in most estimates of a country's WMD infrastructure. As a result, U.S. and allied forces are almost certain to encounter previously unknown sites.

The existence of unlocated critical sites complicates planning because it could entail the need to be on the lookout for unlocated sites and to search multiple potential sites before the actual site is found. This could result in the deployment of more WMD-E TFs than would be required if perfect information about these sites was

Table B.2
Notional Potential DPRK WMD Target Set

Site Category	Total Sites	Highest-Priority Sites	Other Sites
Nuclear	39	9	30
Chemical	38	15	23
Biological	15	10	5
Missile	49	12	37
Total	141	45	96

SOURCE: NTI; RAND estimates.

available. This problem highlights the critical importance of intelligence in supporting WMD-E operations, and the need to carefully plan to aggressively exploit human and other intelligence sources acquired after the start of operations. The potential to come upon previously unidentified sites during operations also suggests the need to ensure that all maneuver forces are familiar with the WMD-E mission and have some minimum capability to secure and monitor such sites until they can be handed off to other units for elimination and other related missions. In addition, it suggests the need to have a reserve WMD-E TF capability to handle unanticipated missions, and to have forces designed to go to military headquarters and perform the debriefing and document exploitation likely required to locate sites.⁴

The problem of maneuver forces encountering weapons caches is more difficult, and to a large extent falls outside of the WMD-E TF paradigm as laid out in current doctrine (and this is one shortfall of that doctrine). In a country such as North Korea, such sites may be too numerous—or uncertain as to size or location—to be allocated only or mainly to WMD-E TFs. To fill in for the potential absence of WMD-E TFs likely to be overtasked elsewhere, the Army needs to develop TTP for maneuver units and their support elements to locate, identify, and such caches for later exploitation and reduction.⁵ Alternately, WMD-E capabilities will need to be task organized with maneuver forces to ensure broad coverage.

DPRK Nuclear Sites

Securing the DPRK's potential nuclear arsenal and facilities would be perhaps the most critical U.S. task, as nuclear weapons have the greatest potential to cause signifi-

⁴ DPRK military headquarters of various types will likely know the location of some previously identified sites, because they have responsibility for such sites and/or because they provide security to those sites.

⁵ This might parallel the inclusion of WMD-sensitive site teams with the 3rd Infantry Division in the initial phase of OIF. Their purpose was to conduct reconnaissance of sites that the 3rd Infantry Division might encounter while executing its maneuver tasks. These teams would have been too small to exploit any sites that may have been found.

cant immediate damage to U.S. and South Korean populations, and because of their potential proliferation risk.

As of early 2013, this potential arsenal remains relatively modest in number. The Institute for Science and International Security (ISIS) estimates that the DPRK probably has between 34 and 36 kilograms of separated plutonium, enough to make 6–18 weapons.⁶ ISIS also assesses North Korea as having the capability to produce weapon-grade uranium, but the extent of this program is highly uncertain. Given the uncertainties involved, ISIS has estimated that by late 2011, North Korea could have produced anywhere between zero and 332 kilograms of weapon-grade uranium, enough for up to 17 nuclear weapons. Altogether, estimates suggest that North Korea's nuclear arsenal could range from ten to 35 weapons (with a central estimate of 12–23 weapons).

NTI's list of North Korean nuclear sites identifies a total of 57 facilities that are potentially linked to the DPRK's program.⁷ Nineteen of these, however, are located within the confines of the Yongbyon Nuclear Research Center and are treated as a single facility in Table B.1. Of the remaining 38 facilities, we judge that another eight should be considered among the highest-priority nuclear facilities. Of the remainder, 21 are identified or suspected uranium mines, uranium deposits, and uranium processing facilities, two are incomplete or never-built nuclear reactor sites, and seven are associated with nuclear research and development or educational training.

Since the notional list does not classify these 21 sites as holding weapons or components, we did not include them among the primary sites to be exploited by the WMD-E TFs. However, the JTF might be ordered to search these sites anyway because there may be scientists and documents present that the United States would need to collect to prevent proliferation. Also, some of these sites are relatively close to the RoK border, and it may be that U.S. forces would have time to search these facilities while other JTF maneuver forces are advancing toward—or seizing and securing—higher-priority sites. If they are not searched by a WMD-E TF, these sites may require a survey by reconnaissance teams trained and equipped to identify weapons and components, and intelligence personnel capable of interrogating personnel encountered there. If they contain dangerous materials, these sites would need to be guarded until appropriate organizations could be sent in to deal with them.

Other sources provide different estimates of the number of nuclear WMD facilities in North Korea. The IAEA has a smaller list of DPRK nuclear facilities it is remotely monitoring that includes 11 declared and undeclared facilities, nearly all of which are

⁶ ISIS narrows this range to between 12 and 23 nuclear weapons by the end of 2011, weapon-grade uranium for additional weapons could have since been produced. ISIS modeling of weapon-grade uranium production includes the possibility of a secret separate enrichment facility operating since 2005. David Albright and Christina Walrond, *North Korea's Estimated Stocks of Plutonium and Weapon-Grade Uranium*, Institute for Science and International Security, August 2012.

⁷ This figure has been derived by adjusting NTI's list of 59 facilities to remove two facilities that were listed twice.

located in Yongbyon.⁸ At the other end of the spectrum, the South Korean Ministry of Defense has asserted that there are “about 100 sites related” to the DPRK’s nuclear program.⁹ For our notional campaign analysis, we chose as our starting point those facilities that would almost certainly be a priority for an exhaustive search. The JTF—comprising the WMD-E TFs and other maneuver and supporting forces—would have to be prepared to exploit additional sites as they are discovered (either by intelligence or by running into them) or added to the list by U.S. authorities.

We began with nine potentially critical nuclear related sites: the Yongbyon Nuclear Research Center, one nuclear test site, four additional undeclared nuclear enrichment sites, one suspected underground nuclear storage site, one undeclared underground enrichment and reprocessing site, and one site associated with nuclear weaponization.¹⁰

As we discuss in the main text, we envision that each site will be searched and exploited by battalion-sized WMD-E TFs, including maneuver forces and specialty WMD reconnaissance, disablement, and mitigation personnel. However, additional BCTs, combat aviation, and support elements will be required to safeguard LOC and defend against DPRK remnants and irregular forces.

High-Priority Nuclear Sites: Given the criticality of securing the DPRK’s nuclear weapons, fissile material, components, scientists, other knowledgeable workers, and documentation, our initial estimate assumes that U.S. operations would focus on the DPRK’s nuclear sites, while U.S. coalition partners would take responsibility for chemical and biological WMD sites. At the low end, we estimated the need for at least 12 large WMD-E TFs for the first wave of assaults against what we judged to be nine of the highest-priority DPRK nuclear sites: two WMD-E TFs to be deployed to Yongbyon Nuclear Research Center;¹¹ eight to be deployed to eight other nuclear-related facilities; including the enrichment, underground storage, test, and weaponization sites identified by NTI; and two additional WMD-E TFs held in reserve to exploit pop-up targets, weapon caches deployed with ballistic missiles, or previously unidentified sites.

⁸ The IAEA is currently unable to inspect DPRK nuclear facilities, but it is monitoring DPRK activity by satellite. There are two undeclared facilities in Yongbyon, a light water reactor currently under construction and a uranium enrichment plant, also being monitored by the IAEA. Unlike the NTI list, the IAEA list does not include suspected or rumored covert facilities, but the number of such facilities is likely to be quite small. IAEA, *Application of Safeguards in the Democratic People’s Republic of Korea*, GOV/2012-36-GC(56)/11, August 30, 2012.

⁹ “Seoul Suspects About 100 Sites in N.K. Related to Nuclear Program,” *The Korea Herald*, March 30, 2010.

¹⁰ NTI, undated-b. While differing in their particulars, other sources provide comparably low numbers of key DPRK nuclear sites: GlobalSecurity.org reports that the DPRK has “as many as 22 nuclear sites at 18 locations,” while the International Institute for Strategic Studies identifies eight major nuclear program facilities and International Crisis Group identifies three major DPRK nuclear warhead sites. Our parametric analysis of the number of sites ranges from five to 50. See GlobalSecurity.org, undated; International Crisis Group, 2009, p. 30.

¹¹ The Yongbyon site comprises 23 of the nuclear facilities listed by NTI; we combined these facilities into a single, very large site, and assigned two WMD-E battalion TFs to the exploitation task.

DPRK CW Sites

The U.S. intelligence community believes that the DPRK has a longstanding CW program with the ability to produce bulk quantities of nerve, blister, choking, and blood agents.¹² In 2009, the RoK government estimated that between 2,500 and 5,000 metric tons of CW agents have been stockpiled by the DPRK and that this size of this stockpile has remained stable.¹³ NTI identifies some 38 potential sites associated with the production and storage of this arsenal. This figure includes six storage facilities (three associated the DPRK's II, III, and IV corps), five CW production facilities, 15 dual-use facilities, and 12 other CW associated facilities and organizations. A more detailed assessment of North Korea's CW program by the International Crisis Group estimates the number of critical facilities includes six storage facilities, three CW production plants, five dual-use plants, and one production and research and development facility.¹⁴ Notably, both of these estimates exclude potential CW sites associated with North Korean Army artillery and missile formations. As mentioned in the main body of the text, it is highly likely that U.S. and RoK maneuver forces will encounter CW caches located with forward-deployed DPRK artillery units.

High-Priority Chemical Sites. In regard to CW facilities, as shown in Table B.2, NTI estimates a total of 38 CW sites, of which we judge 15 to be high-priority sites. By comparison, sources close to the RoK government identified some 28 facilities in 2006: four military bases equipped with CWs, 11 facilities where CWs are produced and stored, and 13 locations involved in CW research and development work.¹⁵ Earlier official RoK government numbers had identified 17–19 CW-related facilities.¹⁶ In 2004, Harris reported that press accounts and journal articles had collectively reported that more than three-dozen locations and specific facilities have been associated with the DPRK's CW program between 1984 and 2004, very close to NTI's current estimate.¹⁷

¹² Director of Central Intelligence (DCI), *Unclassified Report to Congress on the Acquisition of Technology Relating to Weapons of Mass Destruction and Advance Conventional Weapons, Covering 1 January to 31 December 2007*, 2008, p. 5. More recent DCI reports have simply stated that “we judge Pyongyang possesses a stockpile of agents.” DCI, *Unclassified Report to Congress on the Acquisition of Technology Relating to Weapons of Mass Destruction and Advance Conventional Weapons, Covering 1 January to 31 December 2011, 2012*, p. 5

¹³ International Crisis Group, 2009, p. 7. A stockpile in this range would be sufficient for between 560,000 and 1,100,000 152mm shells filled with liquid mustard gas or between 380,000 and 760,000 122mm rockets filled with 6 liters of sarin.

¹⁴ International Crisis Group, 2009.

¹⁵ NTI, undated-c, citing Korea Research Institute of Chemical Technology report.

¹⁶ According to Elisa Harris, South Korea's 1996–1997 Defense White Paper located on a map, but did not identify, 17 CW facilities: eight production, six storage, and three research sites. By the 2001 Defense White Paper, this figure had increased to eight production, seven storage, and four research sites. Elisa D. Harris, “Threat Reduction and North Korea's CBW Programs,” *The Nonproliferation Review*, Fall–Winter 2004, p. 88.

¹⁷ Harris, 2004, p. 89.

If the forces provided are at the lower end of requirements, we assume that these sites will be secured and exploited by RoK forces. However, the U.S. JTF commander should have contingency plans in place to exploit these sites if ordered to do so. It may be impossible for the JTF commander to know ahead of time how large a unit would be needed to appropriately exploit each site (and, at any rate, it is impossible for us to assess the size of these sites based upon the unclassified sources available for this analysis). Therefore, in our analysis we simply assume that the JTF commander would send a battalion-sized WMD-E TF to each site he is assigned to search; along with the appropriately sized maneuver force to seize and secure the sites and LOC to them.

DPRK Bioweapons Sites

NTI has identified 15 facilities potentially associated with a DPRK BW program, including one potential weaponization facility, three production facilities, and 11 potential research and design facilities and organizations.

Other estimates also are available. For example, the International Crisis Group has identified a more limited number of potential BW facilities, including three possible BW production facilities and seven BW or BW-related research centers.¹⁸ Few details are available about these institutions and we assume that they are, for the most part, small laboratories. In 2001, South Korea stated that North Korea had nine BW facilities: six research facilities and three production facilities.¹⁹ However, by 2006, Korean and other sources had identified more than 24 facilities potentially associated with North Korea's BW program.²⁰ At the high end of the scale, Bennett and Lind assumed that North Korea had approximately 100 sites associated with its CW and BW programs combined.²¹

For its part, the U.S. intelligence community believes that the DPRK has a biotechnology infrastructure that "could" support the production of BW agents, as well as the weapon production infrastructure to weaponize them.²² In the recent past, however, this infrastructure has been categorized as "rudimentary."²³ In addition,

¹⁸ International Crisis Group, 2009, p. 11.

¹⁹ Harris, 2004, p. 89.

²⁰ Harris, 2004, p. 89.

²¹ "In 2009, South Korea's defense minister testified that there were about 100 sites in North Korea related to its nuclear program. We assume roughly the same number of facilities for its chemical and biological weapons programs (i.e., a total number of WMD facilities of perhaps 200)." The authors do not provide additional detail on the basis for their estimate of 100 CBW sites. Bruce W. Bennett and Jennifer Lind, "The Collapse of North Korea: Military Missions and Requirements," *International Security*, Vol. 36, No. 2, Fall 2011, p. 101.

²² DCI, 2012, p. 5

²³ DCI, 2008, p. 5

according to the International Crisis Group, both the South Korean government and the U.S. military believe that the DPRK has thus far failed to weaponize BW agents.²⁴

High-Priority BW Sites. Based on the International Crisis Group numbers, we posit that there might be ten very small, high-priority, BW-related installations. For the low-end case, we have assumed that U.S. forces will not be tasked to exploit BW sites. However, similar to our assessment of the CW sites, the U.S. JTF commander should have contingency plans in place to exploit these sites if ordered to do so. For the purposes of our parametric analysis, we assume that the JTF commander would send a battalion-sized WMD-E TF to each site he is assigned to search, along with the appropriately sized maneuver force to seize and secure the sites and LOC to them.

DPRK Ballistic Missile Sites

NTI identifies 49 sites potentially associated with North Korea's ballistic missile program: 25 "missile bases," 22 missile production facilities, and two research and design facilities. Ballistic missiles, however, are not WMD and most of the facilities associated with them are better suited for exploitation by technical intelligence teams rather than WMD-E TFs.²⁵ A critical exception to this would be warhead storage facilities associated with North Korea's ballistic missile brigades and battalions, as they could contain either nuclear or chemical warheads. North Korea's long-range missile forces are generally believed to consist of three brigades, each with three battalions having six to nine TELs/mobile erector launchers.²⁶ Assuming one warhead storage facility per battalion, there are nine potential WMD-E sites associated with North Korea's Scud,

²⁴ International Crisis Group, 2009, p. 23. However, RAND colleague Bruce Bennett cites Lester C. Caudle, who reports a contrary view:

During the 1990s, hostilities have mounted in North Korea over allegations that evidence of nuclear weapons activities is being hidden from international inspectors. This is the kind of future conflict that could involve the United States. In 1993, the Russian Foreign Intelligence Service, successor to the Soviet Union's KGB, released a statement that said, in part, that

North Korea is performing applied military-biological research in a whole number of universities, medical institutes, and specialized research institutes. Work is being performed in these research centers with inducers of malignant anthrax, cholera, bubonic plague and smallpox. Biological weapons are being tested on the island territories belonging to the DPRK.

Mr. Gordon Oehler, director of the CIA's Non-Proliferation Center, confirmed this Russian report.

Lester C. Caudle, III, "The Biological Warfare Threat," in Brigadier General Russ Zajtchuk and Ronald F. Bellamy, eds., *Medical Aspects of Chemical and Biological Warfare*, Washington, D.C., Office of the Surgeon General, 1997.

²⁵ The exploitation of missile facilities could require some CBRN capabilities because the fuel associated with many ballistic missiles is highly toxic.

²⁶ Joseph Bermudez, "Behind the Lines—North Korea's Ballistic Missile Units," *Jane's Intelligence Review*, June 2011.

Nodong, and Musudan missiles.²⁷ To this figure we add one additional site associated with North Korea's suspected road-mobile intercontinental ballistic missile. Finally, although rarely used, North Korea's two ballistic missile test facilities could potentially store WMD and thus can also be considered potential candidates for a WMD-E TF. Thus, we estimate a total of 12 DPRK missile sites might be suitable targets for WMD-E TFs.

High-Priority Missile Sites. For the purpose of allocating WMD-E TFs, we consider all of the missile facilities to be large.²⁸ At the low end of potential force sizes, the two unassigned battalion-sized WMD-E TFs could be assigned to target missile sites—along with biological or chemical sites.

Syrian WMD Sites

Syrian CW Sites

To remind the reader, in August 2014, the United States reported that the Syrian CW program had been destroyed, although certain unspecified “omissions and discrepancies” in the Syrians' disclosure also were noted. For purpose of our analysis, we accordingly used the Syrian case as a counterfactual scenario to estimate the forces that might have been required had the Syrian regime not agreed to inspections and dismantlement of its CW program, and had U.S. military forces been ordered to undertake WMD-E operations.²⁹

²⁷ The brigade headquarters associated with each missile brigade would be a critical intelligence target, but would not require a WMD-E TF.

²⁸ A missile battalion cantonment could be physically quite large, but its warhead storage facilities are likely to be well secured and limited in size. Still, each Scud battalion is likely to have 200 or so Scud warheads, which will primarily contain CWs or likely 50 to 100 tons of CWs. Storage for these weapons will likely be done underground and compartmentalized in large and/or multiple underground facilities to reduce the risks of accidental explosions that lead to sympathetic spread of the explosions. Similarly, while the two launch facilities physically take up a large area, the portion needing to be secure may be relatively modest and consist primarily of underground facilities potentially on the site.

²⁹ A brief history of the Syrian chemical destruction effort follows. By the fall of 2012, in the face of growing pressure from the international community, Syria reportedly had dispersed its chemical weapons to about 50 sites (see Karin Laub, “Few Good Options to Secure Syria Chemical Arsenal,” Yahoo.com, October 13, 2012). By January 2013, there were news reports that “Some consolidation of the Syrian arsenal has already occurred on Assad's orders, and the bulk of it is now at fewer than a dozen sites, according to a U.S. official familiar with intelligence estimates.” (R. Jeffrey Smith, “U.S. Seeks to Outsource Handling of Syrian Chemical Weapons,” The Center for Public Integrity, January 17, 2013.) In September 2013, Syrian President Assad agreed to a deal to destroy Syria's chemical weapons. OPCW efforts to remove the chemicals from Syria actually began in January 2014 and, on August 18, the United States declared that the OPCW effort to destroy Syria's chemical weapons had been completed, although Secretary of State Kerry also noted at the time unspecified “discrepancies and omissions” in Syria's original chemical weapons declaration that still needed to be resolved (see Rapoport, 2014). On August 28, 2014, the OPCW declared that 100 percent of Syria's Category 1 chemicals had been destroyed (see OPCW, “OPCW: All Category 1 Chemicals Declared by Syria Now Destroyed,” August 28, 2014).

Table B.3 lists Syrian chemical production, bulk storage, weapons depots, and secondary sites, and Table B.4 reports NTI's estimates of the numbers of potential Syrian CW facilities and missile sites that might have been in the target set for U.S. WMD-E operations; both tables are snapshots of the Syrian CW program as it appeared prior to the recently completed OPCW operations to eliminate the program.

Syrian Missile Sites

The U.S. intelligence community believes that Syria possesses a large ballistic missile force, consisting primarily of Scud missile variants, but also including SS-21 short-range ballistic missiles (SRBMs).³⁰ NTI identifies nine sites potentially associated with Syria's SRBM program: five potential missile production and basing facilities, two research and development facilities, one educational facility, and one regulatory facility.³¹ Other sources indicate that Al Safir is where Syria's SRBMs are garrisoned.

High-Priority Missile Sites. For the purpose of allocating WMD-E TFs, we assume that all of Syria's missile-related sites are small. With the exception of Al Safir, none of these sites are critical enough to require the deployment of a WMD-E TF. Al Safir is the critical Syrian missile-related facility, but as this site is co-located with Syria's primary CW production and storage facility, it does not require a separate WMD-E TF.

Table B.3
Chemical Facilities in Syria

Primary Sites	Weapons Depots	Secondary Sites
Production (4) <ul style="list-style-type: none"> • Al-Safira CW Production Facility • Homs Refinery (Alleged), Homs • Hama CW Facility (Alleged), Salamiyah • Latakia CW Facility, Latakia 	Weapons Storage (20) <ul style="list-style-type: none"> • An Nasiriya AB • Dumayr AB • Shayrat AB • Tiyas AB • Marj Ruhayyil AB • 15 x BM-21 MRL Battalion Ammunition Storage Sites	Dual Use Production Facilities (4) <ul style="list-style-type: none"> • Banias Oil Refinery • Homs General Fertilizer Company • Homs Oil Refinery • Setma Unlimited, Damascus Research and Development (1) <ul style="list-style-type: none"> • Centre D'Etude et Recherche Scientifique (CERS)
Bulk Storage (3) <ul style="list-style-type: none"> • Furqlus Depot • Khan Abu Shamat Depot • Masyaf Facility 		

³⁰ DCI, 2012, p. 6.

³¹ NTI, undated-f.

Table B.4
Notional Syrian WMD Target Set

Site Category	Total Sites	Highest-Priority Sites	Other Sites
Chemical	12	7	5
Biological	1	0	1
Nuclear	23	0	23
Missile	9		9
Subtotal	45	7	38
Rocket/Aircraft Caches	20	20	0
Total	65	27	38

SOURCE: NTI; RAND estimates.

Scenario Context for DPRK Case Study

Scenario Context

Potential Scenarios and Objectives

One of the greatest challenges for U.S. WMD-E operations would be that posed by a WMD-E mission in North Korea, which is believed to possess nuclear and chemical weapons, and numerous facilities (including BW facilities) and capabilities to research, manufacture, store, and employ WMD. A WMD-E mission in North Korea could start one of several ways, including:

- a war between North and South Korea—in which the North Koreans threaten or use WMD and the United States, the RoK, and allies respond with massive conventional force to destroy the DPRK regime and its WMD and conventional warfighting capabilities
- a conventional war between North and South Korea—ending in a defeat of the North Korean armed forces and the collapse of the DPRK regime started by a North Korean invasion of South Korea; or precipitated from a cycle of DPRK provocations that lead to a general war
- a collapse of the DPRK regime precipitated by worsening economic, social, and political conditions.

A typical invasion scenario might begin with a bombardment of South Korea by DPRK artillery overlooking the DMZ. CWs may or may not be included in this bombardment. It would be followed by North Korean armored and infantry forces attacking across the DMZ. South Korean civilian casualties would likely be very high, and South Korea would have to evacuate Seoul and large portions of its territory close to the DMZ. Ultimately, South Korean, U.S., and allied forces would halt this invasion and decimate the attacking units, follow-on forces, and military targets throughout the DPRK. South Korea would almost certainly then begin a counteroffensive with the objectives of destroying the DPRK artillery positions in range of South Korea and DPRK CWs if they were used. It may be likely—depending upon the determination of the South Korean nation—that they would seek an end to the DPRK regime.

War could also begin with a deadly provocation by the DPRK—similar to its shelling of Yeonpyeong Island that resulted in the deaths of both military personnel and civilians. A future provocation is likely to spark a much stronger South Korean response—including strikes against DPRK military targets.¹ An escalation spiral might result—leading to a continuing, general bombardment by each side and the possible use of CWs by the DPRK. As in the invasion scenario discussed previously, South Korea is likely to suffer massive civilian casualties necessitating a retreat from Seoul and other areas within range of the DPRK artillery. Unwilling to allow this violence and dislocation to persist indefinitely, South Korea would likely feel compelled to conduct a ground and air campaign across the DMZ with the minimum objective of seizing these sites and creating a buffer zone far enough north to prevent future such attacks. This campaign would be resisted by dug-in DPRK ground forces—who, in this scenario, have not been severely damaged attacking the RoK. Furthermore, if the DPRK used CWs, South Korean forces would need to essentially take all of North Korea to preclude the future use of ballistic missiles.

Finally, it might not be a war at all; the DPRK could simply collapse, exposing its already weakened population to starvation and violence from military remnants and leaving its nuclear program open to theft and proliferation and transfer to terrorists. South Korea, the United States, China, and other nations would eventually feel compelled to respond in some fashion. One possibility would be an international effort to deliver humanitarian assistance and return some stability to the nation. South Korea would almost certainly wish to coax the artillery forces within range of Seoul and other areas out of their positions—and then permanently close them. South Korea might also wish to secure DPRK air and missile forces and their WMD program—but a campaign to do so might be quite deliberate. The United States would almost certainly wish to secure the DPRK nuclear program as swiftly as possible—but would have to proceed in the presence of a large DPRK military force that might remain largely intact.

In some sense, each of these scenarios ends in the collapse of the DPRK government and military—though due to very different causes. In the main body of this report, we simply consider various states of DPRK collapse, without really considering the causes of this collapse.

Campaign Design

In developing a campaign plan for the scenarios above, the three biggest questions may boil down to:

1. How far will U.S. and allied forces push?
2. How fast will they plan to advance?

¹ See Chico Harlan, “Yeonpyeong Attack Raised South Korea’s Resolve,” *Washington Post*, April 16, 2013.

3. Where and under what terms do they plan to meet Chinese forces?

In the cases of the first two scenarios above, South Korea will have a strong incentive to take control of virtually the whole of North Korea. Returning to the prewar boundaries would invite a return of North Korean forces to their original positions and the prospect of future attack. Establishing some more northern boundary—out of artillery range of South Korea—would require the South Korean forces to remain deployed in this new place and vulnerable to continuing attack. And both these forces and South Korean cities would remain vulnerable to TBM attack with conventional or chemical weapons. The degree to which North Korea inflicts damage on the South in initial attacks or resistance to a subsequent counteroffensive may determine how far South Korea is determined to go out of prudence—if not retribution.

In a collapse scenario, the United States could have an even greater incentive to secure nuclear facilities before they were completely looted. How far South Korea would push is much less clear. A limited ambition would be to clear areas within artillery range of South Korea as before—and to use that space to create areas within North Korea to provide humanitarian assistance. There would be some interest in securing TBMs and WMD—but efforts to do so could be very deliberate from a South Korean perspective.

How fast the various campaigns would proceed also varies. In the first two cases, the advance on WMD facilities would have to wait for the destruction of the forward-deployed DPRK forces and positions. Once eliminated, combined RoK-U.S. forces could swiftly move north—though their subsequent objectives may differ. The United States would almost certainly focus on nuclear and related missile sites—perhaps leaving South Korean forces to mop up remaining DPRK military forces and suspected CW sites. Meanwhile, South Korea might focus on securing Pyongyang and other political objectives, and perhaps those chemical and missile sites still threatening to South Korea.

Once again, the collapse scenario is much less clear. It may take months before South Korea and the United States decide to cross into North Korea to render aid and secure WMD. Once in the north, the United States would need to decide whether to first assist RoK forces in securing and closing artillery sites overlooking Seoul, or to immediately push on toward DPRK nuclear facilities. If the decision is to advance immediately to the nuclear facilities, a subsequent decision is whether to secure and inspect chemical or biological facilities along the way or to focus exclusively on nuclear facilities.

Establishing where and on what terms RoK and U.S. forces will meet the Chinese is one of the most important questions. Due to its proximity, absence of significant military barriers, existence of more rail lines and roads into China than into South Korea, and the sheer size of its military, China can essentially penetrate as far into North Korea as it chooses. How much of North Korea it chooses to control, and how

many responsibilities it wishes to accept in that area, are some of the choices that China has the capacity to make on its own. It would benefit South Korea and the United States to reach some agreement with China on how diligently it will seek, identify, and secure nuclear sites in the areas that it ultimately occupies. Also, South Korea, the United States, and China should work out how to deconflict their operations and forces—including how they will approach one another and operate in proximity without inadvertent hostilities.

WMD Sites and Force Planning

As describe above, NTI estimates that a total of 141 WMD sites may exist in North Korea, although our analysis suggests that only about a third of these (45) might be sufficiently important to warrant WMD-E TFs. Many more hidden sites—both prepared and ad hoc—are likely to be discovered during an actual operation. Ultimately, the U.S. commander will almost certainly be ordered to ensure that every site under the control of U.S. or South Korean forces has been thoroughly inspected.

For this purpose, multiservice doctrine specifies WMD-E TFs able to secure, search, identify, render safe, and remove weapons and collateral materials. These TFs would be task-organized and sized for a given mission, with a combined-arms battalion, company, or platoon at their core. The combined-arms unit provides the inner cordon, armed search teams (they may encounter opposition in any given building or bunker), and security elements. Their size is based on the area to be searched and the level of self-protection needed to operate in a hostile environment.

To estimate the size of the ground force needed to secure, search, and remove weapons from North Korean WMD sites, we made the following assumptions:

- The force would be sized for the nuclear sites—chemical and biological sites would be secured from looting with search and removal operations to be conducted after the nuclear sites, or would be searched by South Korean forces if they reached them first.
- The most important nuclear sites—those separating materials, manufacturing weapons, or holding finished weapons—will be relatively large due to the complexity of their functions, and well protected due to their importance to the regime.
- These sites would be prioritized based upon a combination of factors, including their prospects of holding complete weapons and how quickly U.S. forces can reach them.
- The ground force would include units with several distinct missions:
 - maneuver forces to provide area and LOC security, deter or defeat attack by irregular forces or complete units, and provide the outer cordon for sensitive site exploitation efforts

- WMD-E TFs to accomplish the inner cordon, search, seize, render safe, and remove functions
- “follow-on” forces to continue operations at sites that have been cleared of nuclear materials, but which still contain dangerous CWs or materials, or other dangerous military stocks.²

Given these assumptions, we judge that the WMD-E TFs assigned to the highest-priority sites will be based on combined-arms battalions to provide the search capacity and self-protection capabilities needed. Large sites will require more than one. Each WMD-E TF will require about 30 days to move to a given site, complete the full exploitation mission, hand off to “follow-on” forces that will provide continuing site security, and prepare for movement to a new site.³ We can then parametrically estimate the overall length of the campaign based upon the number of WMD-E TFs provided.

Several factors might enable U.S. forces to shorten this campaign length:

- Some sites may turn out to be smaller than expected.
- Some sites may be clearly abandoned—making searches shorter.
- Time to pack up and move between sites may be shorter than estimated.
- The Chinese or allied forces may take responsibility for exploiting some sites.
- Of course, several factors may lengthen the campaign:
- Sites are larger than expected—with underground bunkers or complexes.
- Sites are defended by internal security forces, or access is hampered by booby traps or debris.
- Collection, removal, and shipment of nuclear materials takes longer than expected—or movement between sites is hampered.
- Chinese or allied forces request U.S. forces to assist in exploiting sites under their control.
- New sites are discovered.

² Concept developed by RAND colleagues Bruce Bennett and Jim Quinlivan.

³ See Appendix E, not available to the general public because it contains analysis based on information with restricted distribution.

Review of Available Estimates on Support Ratio in Iraq

In this Appendix, we provide a review of available estimates of the ratio of supporting troops to mission troops in Iraq.

In addition to the direct mission forces, the number of EAB support forces required to support these forces is calculated for each of the mission areas. EAB support includes all units and personnel above the BCT level deployed in support of a BCT during an operation. This can include division-level fires brigades, combat aviation brigades, battlefield surveillance brigade, maneuver enhancement brigades, and sustainment brigades. The various functional combat support and combat service support brigades deployed to support division- and higher-level echelons are also part of the EAB support calculation.

Higher-echelon headquarters units are included in the EAB support forces. These forces are estimated based upon the assumed ratio of support personnel to mission personnel (“support ratio”). The “support ratio” is varied based on assumptions as to how much EAB support might be required in a given operational environment. Since not all mission force types may require identical levels of EAB support, the support ratio can be applied fractionally to a given force type (the “support fraction”). We discuss these concepts in more detail.

Finally, contractors provided the bulk of logistical support operations in OEF, OIF, and Operation New Dawn (OND). We utilized data from the Contractor Census to assess overall support ratios when contractor logistics was included as well as uniformed support.¹ Contractors included U.S. citizens, Host Nation Support, and non-U.S., non-host nation contractors. Support provided by U.S. government civilians from DoD or other government agencies was not included.

There is a range of available unclassified estimates of EAB support requirements for BCT operations in OEF, OIF, and OND that range from 0.84 to 3.71 support personnel per mission troop (see Table D.1).

¹ Contractor Census data from the third quarter of fiscal year 2008 to the second quarter of fiscal year 2013. Office of the Under Secretary of Defense (Acquisition, Technology, and Logistics), *Quarterly Contractor Census Reports*, web page, undated.

Table D.1
Alternate Estimates of Support: Troop Ratios in OEF/OIF/OND

Description	Ratio of Support: Mission Troops	Source
ESTIMATES OF TOTAL SUPPORT (INCLUDING CONTRACTORS)		
OEF/OIF (October 2008)	249,358 : 76,469 (3.3)	Contractor Census Data ^a
OIF Brigade Slice (2008)	9,500 : 4,500 (2.1:1)	Cancian (2008)
OEF/OIF (October 2009)	248,266 : 73,626 (3.4)	Contractor Census Data
OEF/OIF (August 2010)	203,222 : 62,955 (3.2)	Contractor Census Data
EAB Slice for std. modular brigade	6,682 : 3,735 (1.8:1)	McGrath (2006)
Pre-OIF Estimate (Low)	9,750 : 4,500 (2.2:1)	Cancian (2008)
Pre-OIF Estimate (High)	10,500 : 4,500 (2.3:1)	Cancian (2008)
SUPPORT ESTIMATES (NOT INCLUDING CONTRACTORS)		
OEF/OIF (October 2008)	64,000 : 76,469 (0.8)	Army Global Employment Briefing
OIF Brigade Slice (2008)	4,000 : 4,500 (0.9:1)	Cancian (2008)
OEF/OND (October 2009)	74,000 : 73,626 : (1.0)	Army Global Employment Briefing
OEF/OIF (August 2010)	70,500 : 62,955 (1.1)	Army Global Employment Briefing

SOURCES: Mark Cancian, "Contractors: The New Element of the Military Force Structure," *Parameters*, Vol. XXXVIII, Autumn 2008, p. 69; and John J. McGrath, *The Other End of the Spear: The Tooth-to-Tail Ratio (T3R) in Modern Military Operations*, Fort Leavenworth, Kan.: Combat Studies Institute Press, The Long War Series Occasional Paper 23, 2007; and U.S. Army Global Employment briefings.

NOTES: We assume that 80 percent of the DoD-hired contractors are dedicated to supporting the Army. This is consistent with the relative share of the forces on the ground provided by the Army.

^a Contractor Census data from the third quarter of fiscal year 2008 to the second quarter of fiscal year 2013. Office of the Under Secretary of Defense (Acquisition, Technology, and Logistics), undated.

Based upon a review of these estimates, and in recognition of the considerable uncertainty about "average" or "best estimate" values, we used three (low, medium, high) "support ratios" for our EAB support ratio estimates:

- a low estimate that we use to represent the support required in low-intensity counterinsurgency operations, or a ratio of 1.5:1 support troops to mission troops.²
- a middle estimate, based on the highest prewar estimate of OIF support troop requirements, is assumed to be the requirement for support in high-intensity combat operations where contractors will be less readily available, or a ratio of 2.5:1 support troops to mission troops. We believe that a ratio of 2.5:1 is the most realistic one for the DPRK and Syria scenarios.
- an estimate of 3.5:1 to bound the range of observed ratios on the high end.

² We use 0.89 rather than 0.84 because the security force brigades generally deployed with fewer personnel than BCTs.

For WMD-E units and most other simple cases, the estimated number of support personnel is calculated as the product of mission personnel times the various assumed ratios of support to mission forces (1.5:1, 2.5:1, 3.5:1). For example, if there were 16,885 personnel in the WMD-E mission force, our estimate of support forces would be 25,328 troops (low estimate, 1.5:1 ratio), 42,213 troops (nominal, 2.5:1 ratio), or 59,098 troops (high estimate, 3.5:1 ratio).

Bibliography

32nd AAMDC—See 32nd Army Air and Missile Defense Command.

32nd Army Air and Missile Defense Command, *Operation Iraqi Freedom Theater Air and Missile Defense History*, Fort Bliss, Texas, September 2003.

Abdelaziz, Salma, and Jim Sciutto, “OPCW: Only 11% of Chemical Weapons Removed from Syria,” CNN, February 13, 2014. As of February 2014:
http://edition.cnn.com/2014/02/12/world/meast/syria-civil-war/?hpt=hp_t1

Albright, David, and Christina Walrond, *North Korea’s Estimated Stocks of Plutonium and Weapon-Grade Uranium*, Institute for Science and International Security, August 2012.

“Army Heads into Joint Winter War Game Mulling Smaller, More Agile Force,” *Inside the Army*, February 11, 2013.

“Army TRADOC Pushes for More Expeditionary Force in Capstone Concept,” *Inside Defense Defense Alert*, December 20, 2012.

Baker, Peter, Mark Landler, David E. Sanger, and Anne Barnard, “Off-the-Cuff Obama Line Put U.S. in Bind on Syria,” *New York Times*, May 4, 2013.

Baldor, Lolita C., “U.S. Troops Could Help Secure Syrian Weapons,” Associated Press, January 10, 2013.

Bermudez, Joseph, “Behind the Lines—North Korea’s Ballistic Missile Units,” *Jane’s Intelligence Review*, June 2011.

Bennett, Bruce W., and Jennifer Lind, “The Collapse of North Korea: Military Missions and Requirements,” *International Security*, Vol. 36, No. 2, Fall 2011, pp. 84–119.

Cancian, Mark, “Contractors: The New Element of the Military Force Structure,” *Parameters*, Vol. XXXVIII, Autumn 2008.

Caudle, Lester C., III, “The Biological Warfare Threat,” in Brigadier General Russ Zajtchuk and Ronald F. Bellamy, eds., *Medical Aspects of Chemical and Biological Warfare*, Washington, D.C., Office of the Surgeon General, 1997. As of December 23, 2013:
https://ke.army.mil/bordeninstitute/published_volumes/chemBio/Ch21.pdf

Chairman, Joint Chiefs of Staff, *National Military Strategy to Combat Weapons of Mass Destruction*, Washington, D.C., February 2006.

———, *National Military Strategy: 2011, Redefining America’s Military Leadership*, Washington, D.C., February 8, 2011.

———, “Joint Capabilities Integration and Development System,” CJCSI 3170.01H, January 10, 2012.

CIA—See U.S. Central Intelligence Agency.

Clapper, James R., *Statement for the Record: World Wide Threat Assessment of the U.S. Intelligence Community, Senate Select Committee on Intelligence*, March 12, 2013.

Commission on the Prevention of Weapons of Mass Destruction Proliferation and Terrorism, *World at Risk: The Report of the Commission on the Prevention of WMD Proliferation and Terrorism*, New York: Vintage Books, December 2008.

“Could Countering the Spread of WMD Be the Army’s Next Big Thing?” *Inside the Army*, June 11, 2012.

Counterproliferation Program Review Committee, *Report on Activities and Programs for Countering Proliferation and NBC Terrorism*, Volume I, Executive Summary, May 2011.

“Counter-WMD Mission Again Mentioned as Yardstick in Army Force-Sizing,” *Inside the Army*, November 12, 2012.

DCI—See Director of Central Intelligence.

Defense Manpower Data Center, Contingency Tracking System Deployment File, July 31, 2011.

Defense Threat Reduction Agency and U.S. Strategic Command Center for Combating Weapons of Mass Destruction, “DTRA, SCC-WMD and SJFHQ-E,” Fact Sheet, May 2012.

DeYoung, Karen, “Pentagon Sending Additional Troops to Jordan,” *Washington Post*, April 17, 2013.

Director of Central Intelligence, *Unclassified Report to Congress on the Acquisition of Technology Relating to Weapons of Mass Destruction and Advance Conventional Weapons, Covering 1 January to 31 December 2007*, 2008.

———, *Unclassified Report to Congress on the Acquisition of Technology Relating to Weapons of Mass Destruction and Advance Conventional Weapons, Covering 1 January to 31 December 2011*, 2012.

DoD—See U.S. Department of Defense.

Eun-jung, Kim, “N. Korea’s Nuclear Device Yield Estimated at 6–7 Kilotons: Seoul,” *Yonhap*, February 12, 2013. As of March 2013:

<http://english.yonhapnews.co.kr/national/2013/01/30/66/0301000000AEN20130130008254315F.HTML>

Fontenot, COL Gregory, U.S. Army, Retired; LTC E.J. Degen, U.S. Army; and LTC Dave Tohn, U.S. Army, *On Point—The United States Army in Operation Iraqi Freedom*, Operation Iraqi Freedom Study Group, Office of the Chief of Staff, U.S. Army, Washington, D.C., 2004.

GAO—See U.S. Government Accountability Office.

Gellman, Barton, “Frustrated, U.S. Arms Team to Leave Iraq,” *Washington Post*, May 11, 2003.

Gladstone, Rick, “Russia Says Syria Will Export Chemicals by March 1,” *New York Times*, February 4, 2014.

GlobalSecurity.org, *Weapons of Mass Destruction*, web page, undated. As of June 2013: http://www.globalsecurity.org/wmd/world/dprk/other_nuke.htm

Gordon, Michael R., and Nick Coming-Bruce, “Syria Meets First Test of Accord on Weapons,” *New York Times*, September 20, 2013.

Harlan, Chico, “Yeonpyeong Attack Raised South Korea’s Resolve,” *Washington Post*, April 16, 2013.

Harris, Elisa D., “Threat Reduction and North Korea’s CBW Programs,” *The Nonproliferation Review*, Fall–Winter 2004.

Hersman, Rebecca K. C., *Eliminating Adversary Weapons of Mass Destruction: What’s at Stake*, Center for the Study of Weapons of Mass Destruction, National Defense University Press, Washington, D.C., December 2004.

IAEA—See International Atomic Energy Agency.

International Atomic Energy Agency, *Application of Safeguards in the Democratic People's Republic of Korea*, GOV/2012-36-GC(56)/11, August 30, 2012.

International Crisis Group, *North Korea's Nuclear and Missile Programs*, Asia Report No. 167, June 18, 2009.

International Institute for Strategic Studies, *North Korean Security Challenges: A Net Assessment*, July 2011, pp. 28–29.

Iraq Study Group, *The Iraq Study Group Report*, New York: Vintage Books, 2006.

Iraq Survey Group, *Interim Progress Report*, Washington, D.C., October 6, 2004. As of February 2013:

http://www.ontheissues.org/Iraq_Survey_Group.htm

Joint Chiefs of Staff, *Counterinsurgency*, JP 3-24, November 2013.

Katzman, Kenneth, *Iraq: Weapons Threat, Compliance, Sanctions, and U.S. Policy*, Congressional Research Service, IB92117, updated November 19, 2002.

Kay, David, “Statement by David Kay on the Interim Progress Report on the Activities of the Iraq Survey Group (ISG) Before the House Permanent Select Committee on Intelligence, the House Committee on Appropriations, Subcommittee on Defense, and the Senate Select Committee on Intelligence,” October 2, 2003. As of May 29, 2013:

https://www.cia.gov/news-information/speeches-testimony/2003/david_kay_10022003.html

Kehler, General C. R., “Statement of General C. R. Kehler, Commander, United States Strategic Command, Before the House Committee on Armed Services, Subcommittee on Strategic Forces,” April 17, 2012.

Larrabee, F. Stephen, Stuart E. Johnson, John Gordon IV, Peter A. Wilson, Caroline Baxter, Deborah Lai, and Calin Trenkov-Wermuth, *NATO and the Challenges of Austerity*, Santa Monica, Calif.: RAND Corporation, MG-1196-OSD, 2012.

Laub, Karin, “Few Good Options to Secure Syria Chemical Arsenal,” Yahoo.com, October 13, 2012.

Londoño, Ernesto, “U.S. Military Team in Jordan Planning Ways to Deal with Syria's Chemical Weapons,” *Washington Post*, June 18, 2013. As of September 2013:

http://articles.washingtonpost.com/2013-06-18/world/40047284_1_chemical-weapons-syrian-government-stockpiles

Mazzetti, Mark, Michael R. Gordon, and Mark Landler, “Syria Has Used Chemical Arms on Rebels, U.S. and Allies Find,” *New York Times*, June 13, 2013. As of June 2013:

http://www.nytimes.com/2013/06/14/world/middleeast/white-house-pushes-back-on-bill-clintons-syria-remarks.html?_r=0

———, “U.S. Is Said to Plan to Send Weapons to Syrian Rebels,” *New York Times*, June 13, 2013. As of June 2013:

http://www.nytimes.com/2013/06/14/world/middleeast/syria-chemical-weapons.html?pagewanted=all&_r=0

McGrath, John J., *The Other End of the Spear: The Tooth-to-Tail Ratio (T3R) in Modern Military Operations*, Fort Leavenworth, Kan.: Combat Studies Institute Press, The Long War Series Occasional Paper 23, 2007.

McMenamin, Brigadier General Joseph J., Commander, Iraq Survey Group, *Statement for the Record*, October 2004. As of February 2013:

http://www.au.af.mil/au/awc/awcgate/congress/mcmenamin_6oct04.pdf

Medalia, Jonathan, *North Korea's 2009 Nuclear Test: Containment, Monitoring, Implications*, Congressional Research Service, November 24, 2010.

Miles, Donna, "New Standing Headquarters Focuses on WMD Elimination," American Forces Press Service, June 19, 2013.

Miller, Judith, "After the War: Unconventional Arms; A Chronicle of Confusion in the U.S. Hunt for Hussein's Chemical and Germ Weapons," *New York Times*, July 20, 2003.

Mosely, T. Michael, Lieutenant General, USAF, Commander, U.S. Central Air Forces and Combined Forces Air Component Commander, *Operation Iraqi Freedom—By the Numbers*, Assessment and Analysis Division, April 30, 2003.

Myers, Kenneth A. III, *Statement of Mr. Kenneth A. Myers III on Countering Weapons of Mass Destruction Programs and Activities before the Senate Armed Services Committee, Subcommittee on Emerging Threats and Capabilities*, April 24, 2012.

National Academies and U.S. Department of Homeland Security, "News & Terrorism: Communicating in a Crisis," fact sheet, 2005. As of November 14, 2013:
http://www.dhs.gov/xlibrary/assets/prep_nuclear_fact_sheet.pdf

"NBC Capabilities—Chemical, Syria: Key Facts," *Jane's Nuclear, Biological and Chemical Defense*, July 24, 2012.

Nikitin, Mary Beth, Andrew Feickert, and Paul K. Kerr, *Syria's Chemical Weapons: Issues for Congress*, Washington, D.C.: Congressional Research Service, R42848, December 5, 2012.

Noland, Marcus, Sherman Robinson, and Tao Wang, *Famine in North Korea: Causes and Cures*, Washington, D.C.: Institute for International Economics, 1999.

NTI—See Nuclear Threat Initiative.

Nuclear Threat Initiative, *Facilities Displayed with Google Maps*, web page, undated-a. As of April 10, 2013:

<http://www.nti.org/gmap/?country=syria&layers=biological,chemical,missile,nuclear>

———, *North Korea*, web page, undated-b. As of June 2013:

<http://www.nti.org/country-profiles/north-korea/>

———, *North Korea: Chemical*, web page, undated-c. As of July 17, 2013:

<http://www.nti.org/country-profiles/north-korea/chemical/>

———, *North Korea, Facilities: Nuclear*, web page, undated-d. As of July 2013:

<http://www.nti.org/country-profiles/north-korea/facilities/>

———, *Syria*, web page, undated-e. As of July 2013:

<http://www.nti.org/country-profiles/syria/>

———, *Syria: Facilities*, web page, undated-f. As of July 2013:

<http://www.nti.org/country-profiles/syria/facilities/>

"Odierno: Army's New Counter-WMD Mission Being Worked with SOCOM," *Inside the Army*, June 25, 2012.

Odierno, Ray, U.S. Army Chief of Staff, "CSA Press Conference on Army Force Structure Reductions," press conference transcript, June 24, 2013. As of November 2013:

http://www.army.mil/article/106355/June_25__2013____CSA_Press_Conference_on_Army_Force_Structure_Reductions__As_Prepared_/

ODNI—See Office of the Director of National Intelligence.

Office of the Director of National Intelligence, *Unclassified Report to Congress on the Acquisition of Technology Relating to Weapons of Mass Destruction and Advanced Conventional Munitions, Covering 1 January to 31 December 2011*, Washington, D.C., February 2012. As of February 2013:
<http://www.fas.org/irp/threat/wmd-acq2011.pdf>

———, “Statement by the Office of the Director of National Intelligence on North Korea’s Declared Nuclear Test on February 12, 2013.” As of November 14, 2013:
<http://www.dni.gov/index.php/newsroom/press-releases/191-press-releases-2013/809-statement-by-the-office-of-the-director-of-national-intelligence-on-north-korea's>

Office of the Secretary of Defense, *Report to Congress: Military Situation on the Korean Peninsula*, September 12, 2000.

———, *Military and Security Developments Involving the Democratic People’s Republic of Korea*, February 15, 2013.

Office of the Under Secretary of Defense (Acquisition, Technology, and Logistics), *Quarterly Contractor Census Reports*, web page, undated. As of November 2013:
http://www.acq.osd.mil/log/PS/CENTCOM_reports.html

OPCW—See Organization for the Prohibition of Chemical Weapons

Organization for the Prohibition of Chemical Weapons, *Libya: Facts and Figures*, web page, undated. As of August 21, 2014:
<http://www.opcw.org/the-opcw-and-libya/libya-facts-and-figures/>

———, “Decision: Destruction of Syrian Chemical Weapons,” September 27, 2013a. As of February 2014:
<https://www.opcw.org/documents-reports/executive-council/thirty-third-meeting/>

———, “Note by the Director-General: Progress in the Elimination of the Syrian Chemical Weapons, Programme,” November 26, 2013b. As of December 2013:
http://www.opcw.org/index.php?eID=dam_frontend_push&docID=16886

———, “OPCW: All Category 1 Chemicals Declared by Syria Now Destroyed,” August 28, 2014. As of August 2014:
<https://www.opcw.org/news/article/opcw-all-category-1-chemicals-declared-by-syria-now-destroyed/>

Rappeport, Alan, “Syria’s Chemical Arsenal Fully Destroyed, U.S. Says” *New York Times*, August 18, 2014.

Rosenthal, Andrew, “Government by Random Comment,” *New York Times*, May 6, 2013.

Russell, Alec, “Disillusioned Inspector Quits Iraq Arms Hunt,” *The Telegraph*, January 24, 2004. As of February 2013:
<http://www.telegraph.co.uk/news/1452491/Disillusioned-inspector-quits-Iraq-arms-hunt.html>

Sanger, David E., and Eric Schmitt, “Pentagon Says 75,000 Troops Might Be Needed to Seize Syria Chemical Arms,” *New York Times*, November 15, 2012.

Schmitt, Eric, “Syria Moving Parts of Chemical Arsenal, U.S. Says,” *New York Times*, July 13, 2012.

“Seoul Suspects About 100 Sites in N.K. Related to Nuclear Program,” *The Korea Herald*, March 30, 2010. As of February 2013:
http://www.koreaherald.com/common_prog/newsprint.php?ud=20091005000097&dt=2

Shurkin, Michael, *Setting Priorities in the Age of Austerity: British, French, and German Experiences*, Santa Monica, Calif.: RAND Corporation, RR-222-A, 2013. As of April 28, 2014:
http://www.rand.org/pubs/research_reports/RR222.html

Smith, R. Jeffrey, "U.S. Seeks to Outsource Handling of Syrian Chemical Weapons," *The Center for Public Integrity*, January 17, 2013. As of February 2013:
<http://www.publicintegrity.org/2013/01/17/12033/us-seeks-outsource-handling-syrian-chemical-weapons>

Special Advisor to the Director of Central Intelligence on Iraq's Weapons of Mass Destruction, *Comprehensive Report of the Special Advisor to the DCI on Iraq's WMD, with Addendums (the Duelfer Report)*, Washington, D.C., April 25, 2005. As of February 2013:
<http://www.gpo.gov/fdsys/pkg/GPO-DUELFERREPORT/content-detail.html>

Squassoni, Sharon A., *Iraq: U.N. Inspections for Weapons of Mass Destruction*, Washington, D.C., Congressional Research Service, RL31671, updated October 7, 2003.

Starr, Barbara, "Military: Thousands of Troops Needed to Secure Syrian Chemical Sites," CNN, February 22, 2012. As of February 2013:
<http://security.blogs.cnn.com/2012/02/22/military-thousands-of-troops-needed-to-secure-syrian-chemical-sites/>

Tillson, John C. F., John R. Brinkerhoff, and Robert Magruder, *Total Army Analysis 2009 (TAA09)—A Critical Review*, Alexandria, Va.: Institute for Defense Analyses, D-2809, May 2003, p. S-3.

Under Secretary of Defense for Acquisition, Technology, and Logistics (USD(AT&L)/Counterproliferation Program Review Committee, *Report on Activities and Programs for Countering Proliferation and NBC Terrorism*, Vol. I, Executive Summary, May 2011.

Under Secretary of Defense for Personnel and Readiness, *Defense Manpower Requirements Report, Fiscal Year 2012*, Total Force Planning and Requirements Office, April 2012. As of September 8, 2013:
[http://prhome.defense.gov/Portals/52/Documents/RFM/TFPRQ/Docs/FY12%20Defense%20Manpower%20Requirements%20Report%20\(DMRR\)%20--%20Apr%202012.pdf](http://prhome.defense.gov/Portals/52/Documents/RFM/TFPRQ/Docs/FY12%20Defense%20Manpower%20Requirements%20Report%20(DMRR)%20--%20Apr%202012.pdf)

"Unified Quest Wargame to Advance Army Operating Doctrine," *Jane's International Defence Review*, February 7, 2013.

United Nations, *U.N. Security Resolution 2118*, September 27, 2013. As of February 2014:
<http://unscr.com/en/resolutions/2118>

United Nations Monitoring, Verification and Inspection Commission, *Compendium of Iraq's Proscribed Weapons Programmes in the Chemical, Biological and Missile Areas*, New York, June 2007. As of February 2013:
<http://www.unmovic.org>

UNMOVIC—See United Nations Monitoring, Verification, and Inspection Commission.

U.S. Army, 20th Support Command home page, undated. As of February 2014:
<http://www.cbrne.army.mil>

———, *Technical Escort Battalion Operations*, Washington, D.C., FM 3-11.20, August 2007.

———, *Chemical, Biological, Radiological, Nuclear, and High Yield Explosives Operational Headquarters*, Washington, D.C., FMI 3-90.10, January 2008.

———, *The United States Army Concept Capability Plan for Combating Weapons of Mass Destruction for the Modular Force 2015–2024*, Version 1.0, TRADOC Pamphlet 525-7-19, March 2009.

———, *Multi-Service Tactics, Techniques, and Procedures for Chemical, Biological, Radiological, and Nuclear Aspects of Command and Control*, ATTP 3-11.36, 2010a. Not available to the general public.

———, *Site Exploitation Operations*, Washington, D.C., ATTP 3-90.15 (FM 3-90.15), July 2010b.

- , *Multi-Service Tactics, Techniques, and Procedures for Chemical, Biological, Radiological, and Nuclear Reconnaissance and Surveillance*, Washington, D.C., ATTP 3-11.37, December 2010c.
- , *Multi-Service Tactics, Techniques, and Procedures for Weapons of Mass Destruction Elimination Operations*, Washington, D.C., ATTP 3-11.23, December 2010d. Not available to the general public.
- , *Chemical, Biological, Radiological, Nuclear, and High Yield Explosives Operational Headquarters*, HDQA, FMI 3-90.10, Change 1, February 2011a.
- , *Multi-Service Doctrine for Chemical, Biological, Radiological, and Nuclear Operations*, Washington, D.C., FM 3-11, July 2011b.
- , *Fiscal Year (FY) 2014 Budget Estimates, Volume 1: Operation and Maintenance, Army Justification Book*, April 2013.
- U.S. Army Center of Military History, *XVIII Airborne Corps in Operations DESERT SHIELD and DESERT STORM: An Annotated Chronology*, Historical Resources Branch, updated April 1998. As of November 14, 2013:
<http://www.history.army.mil/CHRONOS/intro.htm>
- U.S. Army National Guard, *Combat Aviation Brigades (CABs) Within the Army National Guard*, web page, undated. As of April 28, 2014:
<http://www.arng.army.mil/News/publications/fs/2009/graphics/cabs.htm>
- U.S. Central Intelligence Agency, *Iraq's Weapons of Mass Destruction Programs*, Washington, D.C., October 2002. As of February 2013:
https://www.cia.gov/library/reports/general-reports-1/iraq_wmd/Iraq_Oct_2002.htm
- U.S. Department of the Army, *2009 Army Posture Statement*, Information Papers, CBRNE Consequence Management, May 2009.
- U.S. Department of Defense, *2000 Report to Congress—Military Situation on the Korean Peninsula*, September 12, 2000.
- , *Quadrennial Defense Review Report*, Washington, D.C., February 2006.
- , “Department of Defense (DoD) Combating Weapons of Mass Destruction (WMD) Policy,” DODD 2060.02, April 19, 2007.
- , *Joint Integrating Concept for Combating Weapons of Mass Destruction*, Version 1.0, Washington, D.C., December 2007.
- , *National Defense Strategy*, June 2008.
- , *Combating Weapons of Mass Destruction*, Washington, D.C., JP 3-40, June 2009.
- , *Quadrennial Defense Review Report*, Washington, D.C., February 2010a.
- , *Nuclear Posture Review Report*, Washington, D.C., April 2010b.
- , *Special Operations*, Washington, D.C., JP 3-05, April 18, 2011a.
- , *Department of Defense Dictionary of Military and Associated Terms*, Washington, D.C., JP 1-02, May 2011b.
- , *Operations*, JP 3-0, August 2011c.
- , *Defense Budget Priorities and Choices*, Washington, D.C., January 2012a.
- , *Sustaining U.S. Leadership: Priorities for 21st Century Defense*, Washington, D.C., January 2012b.
- , *Defense Budget Priorities and Choices: Fiscal Year 2014*, Washington, D.C., April 2013a.

———, “Army Announces Force Structure and Stationing Decisions,” News Release No. 461-13, June 25, 2013b. As of November 2013:
<http://www.defense.gov/releases/release.aspx?releaseid=16114>

———, *Quadrennial Defense Review 2014*, Washington, D.C., March 2014.

U.S. Department of Homeland Security, *Biological Attack: What It Is*, web page, undated. As of November 14, 2013:
<http://www.dhs.gov/biological-attack-what-it>

———, *Nuclear Attack: Supporting Exhibits*, web page, undated. As of November 14, 2013:
<http://www.dhs.gov/nuclear-attack-supporting-exhibits>

U.S. Department of State, *Framework for Elimination of Syrian Chemical Weapons*, September 14, 2013. As of February 2014:
<http://www.state.gov/r/pa/prs/ps/2013/09/214247.htm>

U.S. Government Accountability Office, *Weapons of Mass Destruction: Actions Needed to Track Budget Execution for Counterproliferation Programs and Better Align Resources with Combating WMD Strategy*, Washington, D.C., GAO-10-755R, September 28, 2010.

U.S. Marine Corps, Deputy Commandant for Combat Development and Integration, *Combating Weapons of Mass Destruction (counter-WMD) Operating Concept*, Quantico, Va., September 2010.

U.S. Special Operations Command, *Special Operations Doctrine*, MacDill Air Force Base, Fla., USSOCOM Publication 1, August 5, 2011, pp. 3–40

USSTRATCOM—See U.S. Strategic Command.

U.S. Strategic Command, “Standing Joint Force Headquarters for Elimination,” undated.

———, “Stand Up of SJFHQ-E Enhances Counter-WMD Mission,” press release, February 6, 2012.

“U.S. Weighs Dire Scenarios to Secure Syria’s WMD,” *Agence France-Presse*, August 24, 2012.

Van Pelt, Raymond T., and Jim Currie, *JTF-WMD Elimination: An Operational Architecture for Future Contingencies*, Fort McNair, Washington, D.C.: Industrial College of the Armed Forces, National Defense University, April 28, 2004.

Warrick, Joby, “More Than 1,400 Killed in Syrian Chemical Weapons Attack, U.S. Says,” *Washington Post*, August 30, 2013. As of November, 2013:
http://articles.washingtonpost.com/2013-08-30/world/41606663_1_obama-administration-u-s-intelligence-analysts-syrian-government

“When Regimes Fall: The Challenge of Securing Lethal Weapons, Hearing Before the Subcommittee on Terrorism, Nonproliferation, and Trade of the Committee on Foreign Affairs, 112th Congress, Second Session, July 19, 2012,” Serial 112-163, July 19, 2012. As of February 2013:
<http://www.gpo.gov/fdsys/pkg/CHRG-112hhrg75163/html/CHRG-112hhrg75163.htm>

The White House, *The National Security Strategy of the United States of America*, September 2002a.

———, *National Strategy to Combat Weapons of Mass Destruction*, Washington, D.C., December 2002b.

———, *Proliferation Security Initiative: Statement of Interdiction Principles*, fact sheet, Office of the Press Secretary, Washington, D.C., September 4, 2003. As of October 28, 2013:
<http://www.state.gov/t/isn/c27726.htm>

———, *National Security Strategy*, Washington, D.C., May 2010.

Winnfeld, James, Preston Niblack, and Dana J. Johnson, *A League of Airmen: U.S. Air Power in the Gulf War*, Santa Monica, Calif.: RAND Corporation, MR-343-AF, 1994. As of April 25, 2014:
http://www.rand.org/pubs/monograph_reports/MR343.html

Although two successive presidents have determined that weapons of mass destruction (WMD)—particularly nuclear weapons in the hands of violent extremists—pose the greatest threat to the American people, and have decided that countering their proliferation is a top strategic priority, neither administration has made countering WMD a priority when it comes to allocating budgetary resources to that overarching national mission. In the public domain, little analysis exists that assesses the capacity and capabilities required by military forces to conduct WMD elimination (WMD-E) operations. As a result, public discussion of what capabilities the military requires for such operations generally omits or gives short shrift to requirements for the WMD-E mission. The purpose of this report is to address and analyze those requirements, namely, the ground force capacity (force size) and capabilities (force structure) needed to accomplish WMD-E missions and tasks. In particular, these analyses provide an informed description of the types and size of U.S. Army forces required to conduct WMD-E operations in a wide range of situations.



www.rand.org

\$32.95

ISBN-10 0-8330-8631-6
ISBN-13 978-0-8330-8631-0

