

Heidi Arnesen, Tore Kolås and Barbara Matusiak (NTNU)

A guide to daylighting and solar shading systems at high latitude

ZEB

The Research Centre on Zero Emission Buildings



A world where buildings do not contribute with greenhouse gas emissions

SINTEF Academic Press

Heidi Arnesen, Tore Kolås and Barbara Matusiak (NTNU)

A guide to daylighting and solar shading systems at high latitude

ZEB Project report 3 – 2011

ZEB Project report no 3

Heidi Arnesen, Tore Kolås and Barbara Matusiak (NTNU)

A guide to daylighting and solar shading systems at high latitude

Keywords:

Daylight systems, energy, windows, daylight, transparent facades

(Dagslyssystem, energi, vinduer, dagslys, transparente fasader)

Photo, cover: «Trondheim Kunstmuseum / Trondheim Art Museum», Barbara Matusiak, NTNU

ISBN 978-82-536-1226-3 (pdf)

ISBN 978-82-536-1227-0 (printed)

33 copies printed by AIT AS e-dit

Content: 100 g Scandia

Cover: 240 g Trucard

© **Copyright SINTEF Academic Press and Norwegian University of Science and Technology 2011**

The material in this publication is covered by the provisions of the Norwegian Copyright Act. Without any special agreement with SINTEF Academic Press and Norwegian University of Science and Technology, any copying and making available of the material is only allowed to the extent that this is permitted by law or allowed through an agreement with Kopinor, the Reproduction Rights Organisation for Norway. Any use contrary to legislation or an agreement may lead to a liability for damages and confiscation, and may be punished by fines or imprisonment.

SINTEF Academic Press

c/o SINTEF Building and Infrastructure Oslo

Forskningsveien 3 B, POBox 124 Blindern, N-0314 Oslo

Tel: +47 22 96 55 55, Fax: +47 22 69 94 38 and 22 96 55 08

www.sintef.no/byggforsk

www.sintefbok.no

SINTEF Building and Infrastructure Trondheim

Høgskoleringen 7 b, POBox 4760 Sluppen, N-7465 Trondheim

Tel: +47 22 73 59 30 00

www.sintef.no/byggforsk

www.zeb.no

Norwegian University of Science and Technology

N-7491 Trondheim

Tel: +47 22 73 59 50 00

www.ntnu.no

www.zeb.no

Preface

This work has been performed within The Research Centre on Zero Emission Buildings (ZEB), work package 2 Climate-adapted low-energy envelope technologies.

The main idea for this report is to present a guide to the application of daylighting and solar shading systems for buildings located at high latitudes.

This work is based on the following reports:

- Heidi Arnesen. Performance of Daylighting Systems for Sidelighted Spaces at High Latitudes. Thesis at NTNU, Trondheim, December 2002.
- Tore Kolås. Daylight Redirection Systems. A literature review in the course Daylighting Systems. NTNU, Trondheim, February 3rd 2005 (chapter 5)
- Barbara Matusiak. Lighting Systems in Smart Energy-Efficient Buildings. A State-of-the-Art. NTNU, Trondheim, December 2002. (chapter 6 and 7)

Content

PREFACE	3
CONTENT	4
1 INTRODUCTION	5
2 DAYLIGHT IN BUILDINGS	5
2.1 THE DAYLIGHT SOURCE – DAYLIGHT AVAILABILITY.....	7
2.2 DENSE AREAS - OUTDOOR OBSTRUCTION OF THE SKY VAULT	7
2.3 DAYLIGHT OPENINGS	9
2.4 DAYLIGHT REQUIREMENTS	10
2.5 DESIGN STRATEGIES FOR DAYLIGHT IN BUILDINGS	11
3 CONTROL SYSTEMS AND SMART WINDOWS	12
3.1 CONTROL SYSTEMS	12
3.2 SMART WINDOWS	13
4 DAYLIGHTING SYSTEMS - OVERVIEW	14
5 DAYLIGHT REDIRECTION SYSTEMS	18
5.1 PHYSICAL AND OPTICAL PRINCIPLES.....	18
5.1.1 <i>Optical principles</i>	19
5.1.2 <i>Ceiling properties</i>	21
5.2 DAYLIGHT REDIRECTION SYSTEMS	21
5.2.1 <i>Light shelves</i>	22
5.2.2 <i>Prismatic elements</i>	24
5.2.3 <i>Laser cut panels</i>	27
5.2.4 <i>Louvers and blind systems</i>	29
5.2.5 <i>Sunlighting collection and distribution system</i>	36
5.3 CONCLUSIONS ON DAYLIGHT REDIRECTION SYSTEMS	38
6 INTERACTION BETWEEN DAYLIGHTING AND OTHER TECHNOLOGIES AND STRATEGIES	39
6.1 DAYLIGHTING SYSTEMS AND IMPLEMENTATION STRATEGIES.....	39
6.2 DAYLIGHTING SYSTEMS AND ENVIRONMENTAL CRITERIA	39
6.3 DAYLIGHTING SYSTEMS AND INDOOR ENVIRONMENT	40
6.4 DAYLIGHTING SYSTEMS AND BUILDING INTEGRATED ENERGY SYSTEMS	40
6.5 DAYLIGHTING SYSTEMS AND BUILDING INTEGRATED PHOTOVOLTAIC	40
6.6 DAYLIGHTING SYSTEMS AND HEATING, COOLING AND VENTILATION SYSTEMS.....	41
6.7 DAYLIGHTING SYSTEMS AND HEAT PUMPS.....	42
6.8 DAYLIGHTING SYSTEMS AND OPERATION AND AUTOMATION.....	42
6.9 DAYLIGHTING SYSTEMS AND ENERGY STORAGE.....	43
7 HYBRID LIGHTING	43
8 ECONOMY AND MARKET	46
8.1 THE COST OF LIGHTING	46
8.2 BARRIERS FOR USE OF DAYLIGHTING SYSTEMS	48
8.3 STAKEHOLDERS ATTITUDES TOWARDS DAYLIGHTING SYSTEMS	48
9 MAIN CONCLUSIONS	49
10 REFERENCES AND LITERATURE	50

1 Introduction

Windows create contact between the indoor and the outdoor environment. They give the possibility for view out. Daylight with its excellent color rendering properties can enter through the windows and give valuable lighting for indoor tasks. Daylight and windows also give the possibility for a person to orientate oneself in complex buildings. Another important aspect is the ability of daylight to adjust people's biological clocks to the 24 hours day-night rhythm and to seasonal changes during the year.

Population growth in urban and suburban centres caused the need for extensive area exploitation. A dense placing of deep multi-storey buildings makes the daylight supply to the building interiors difficult. Most critical is the supply of daylight to the lowest floors.

Dense areas together with the characteristic climate at northern latitudes, with generally overcast sky condition and low solar altitudes, has led to increasing demands for adopting building designs allowing better daylight utilization.

In the future, the following trends might contribute negatively with respect to daylight utilization:

- Denser areas - outdoor obstruction of the sky vault
- Reduction of window size (to save energy) causes reduction of the daylight transmission
- Better window U-value means lower light transmission of the glazing
- Thicker walls (more thermal insulation) means poorer penetration of daylight

One of the aims for ZEB is to develop solutions for daylighting and solar shading that reduce energy use for lighting and cooling and that provide a high quality indoor environment. The solutions are to be appropriate for cold climate zones.

This report provides a guide to daylight and solar shading systems that can be applicable for zero emission buildings at high latitudes. The report includes a general introduction to daylight in buildings (chapter 2), an overview of technological solutions (chapter 3, 4 and 5) as well as a discussion related to the interaction between daylighting systems and other building components (chapter 6 and 7).

2 DAYLIGHT IN BUILDINGS

Daylight reaches a point in a room in three different ways (**Figure 2-1**). The first and often the main component is light coming directly from the sky vault, named the *sky component* (SC). The second component, the *externally reflected component* (ERC) is light reaching the point by reflection from external surfaces, while the third component, the *internally reflected component* (IRC) is light reflected from the internal surfaces.

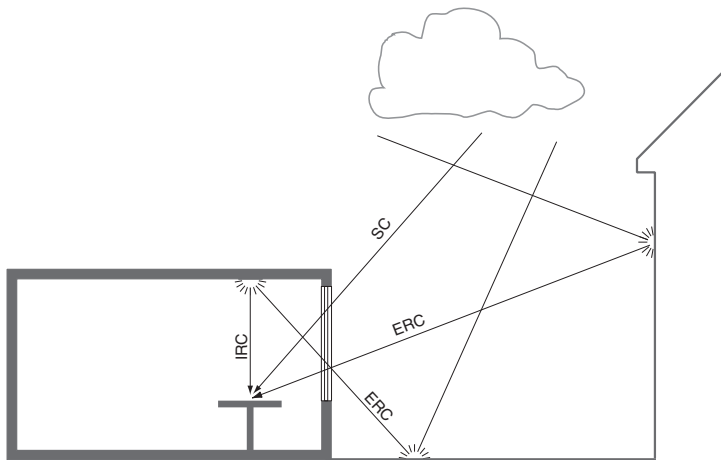

Figure 2-1. The paths of daylight to a point in the room.

The quantitative distribution of each of the three components depends on different parameters and the design phase may affect most of them. The site, the facade orientation and the extent of obstruction are vital for the exposure to daylight. Further, the window design decides how much of the available daylight that manages to enter the room, while both the window location and the room height to depth ratio influence the daylight distribution. The photometric properties of external and internal material surfaces influence the quantity and pattern of the reflected or transmitted daylight. **Figure 2-2** illustrates the main parameters influencing the daylight in sidelighted spaces.

More details about how the different parameters influence the amount and distribution of daylight in a side lighted workspace are presented below.

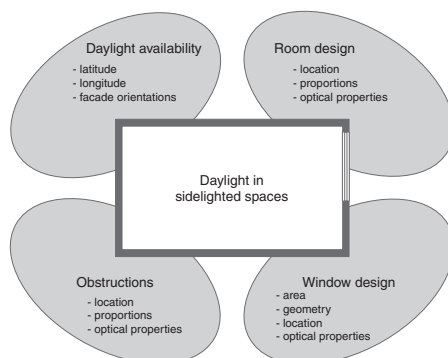

Figure 2-2. Parameters affecting the daylight entering a daylighted room.

The benefits of a window are to bring daylight to the interior as illumination for visual tasks and for creating an attractive visual environment including a view to the outside. Working places in sidelighted rooms may be exposed to visual problems associated with glare, non-uniformity and low lighting levels. Direct sun radiation also often has a negative influence on thermal comfort. Even if the architectural design (building orientation and geometry, window position and design, material properties, obstruction positions and properties, and so on) is closely adapted to the particular site and climate conditions, daylight problems may still exist.

2.1 The daylight source – Daylight availability

The sun and the sky vault are the sources of daylight. The sunlight represents the direct component, while the skylight represents the diffuse component. The intensity of illumination from the sun and the sky varies with the thickness and the composition of the air mass which the light beams passes through. At sunrise and sunset the intensity of the sunlight is lower than at noon. The availability of natural light depends mainly upon the prevailing climate and surrounding conditions for the actual building site. Among other factors, the climate conditions are determined by the geographical position (latitude and longitude) and ground conditions.

Climate affects daylight design in two major ways:

- The position of the sun, described by the altitude and azimuth.
- The cloudiness, described by the cloud index.

Daylight in Norway

Norway is a long and narrow country of which almost one-third lies north of the Arctic Circle. The daylight climate conditions can be characterized by the following factors:

- Relatively low solar altitudes
- Large seasonal variation in day-length
- Frequent cloudy skies
- Relative clear atmosphere

Norway has large seasonal variation of the daylight intensity. The winter is characterized by very low solar altitude and short days while the summer days are long, still with limited solar altitude compared to southern Europe. There are also large differences between south and north in this country.

In the south of Norway (Kjevik) the maximum solar altitude at summer solstice is $55^{\circ}2'$ and at winter solstice $8^{\circ}4'$. In the north (Tromsø) the sun shines continuously for 24 hours for about nine weeks in the summer with a maximum solar altitude of $43^{\circ}7'$, while the night conditions last continuously for about 8 weeks in the winter [SunOrb 1.0].

The low solar altitudes make it difficult to control direct sun radiation and simultaneously allow for daylight inside and an outside view. During the winter, a south orientation of the facade is not preferable due to the low solar altitude. During spring, summer and autumn, facades facing west and east will give the same problems.

It is a general understanding that the sky conditions in Norway mainly are overcast, and Matusiak asserts that the probability for overcast sky during the year is more than 60% [Matusiak 1998].

2.2 Dense areas - outdoor obstruction of the sky vault

An unobstructed window receives daylight from half of the total sky vault. Protruding building elements, other buildings, vegetation and terrain outside the window can obstruct direct view to some part of the sky vault and influence the quantity and distribution of daylight inside a sidelighted room.

The extent of such influence depends on the obstruction size in relation to its distance. The amount of daylight entering through the window is reduced with increasing area of sky obstructed from view. This means that the distance to the obstruction is as important as the height and width of the obstruction. It is therefore natural to define the obstructions by means of obstruction angles (angles of view for the obstructions).

The light transmittance is highest for light incident perpendicular to the glazing surface. An obstruction opposite the window has consequently larger influence on the daylight level than if it is located peripherically at one of the sides. A high, slim obstruction located opposite the window may have less consequence for the daylight supply than a lower obstruction of continuous width.

Overhangs like balconies and eaves shade the daylight entering from the zenithal part of the sky.

Obstruction of the horizon has the largest consequences for the daylight levels in the inner part of rooms, while overhangs level out the daylight throughout the room by reducing the daylight level in the window zone relatively most. An overhang has less consequence for the daylight levels in the back of the rooms compared with horizon obstructions.

Definitions of obstruction angles used in this work, and examples showing what influence such obstructions may have for the daylight level inside an office cell, are presented below. The presentation concentrates on obstructions of large width.

Zenith obstruction angle

Projections above windows like balconies, eaves, etc. will obstruct the zenithal daylight. The *Zenith obstruction angle*, α_z is defined as the angle the obstruction subtend to the zenith from the window reference point, in the vertical section perpendicular to the façade (Figure 2-3).

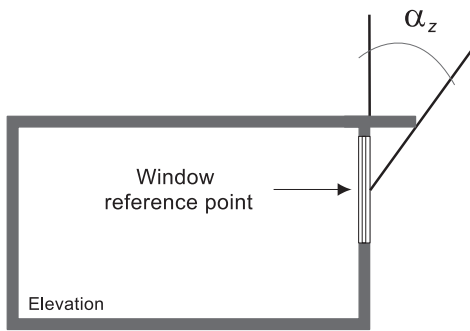

Figure 2-3. Zenith obstruction angle, α_z

Horizon obstruction angle

The horizon obstruction angle, α_h is defined as the angular altitude of the top of the obstruction above the horizon, measured from the window reference point, in a section perpendicular to the facade (Figure 2-4).

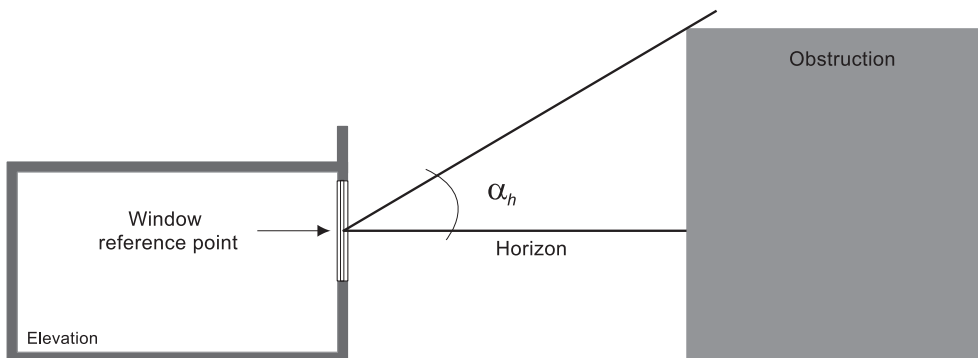

Figure 2-4. The horizon obstruction angle, α_h

Site layout planning for daylight in dense areas

Littlefair has in the extensive report “*Site layout planning for daylight and sunlight*” confirmed that good daylighting may be achievable if the horizon obstruction subtends an angle smaller than 25° from a reference line 2.0 m above the building ground [Littlefair 1991].

Office and apartment buildings in Norwegian cities are often constructed without adequate daylight conditions. The area exploitation ratio is so high that the rooms on the lowest floor often have a daylight supply far below the requirements in the Norwegian building code [Technical regulations 1997]. In order to fulfil Norwegian daylight regulations, care should be taken at an early site planning stage.

2.3 Daylight openings

The main function of a traditional window is to distribute daylight into the building interior and to establish visual contact to the outside environment. Also, windows give the possibility for solar energy gain, open for natural ventilation and can work as an escape route. Windows can also cause negative factors, such as glare, solar overheating and reduced privacy.

Design

The window design; size, proportions, positions, frame and glazing properties are fundamental for the distribution and amount of light entering a building.

Observed from the interior, the window frame and glazing bars constitute the fixture of the daylight source. The design influences the quantity and distribution of daylight entering the room, and also the contrast ratios on the window wall. Light coloured reveals around the window and surrounding areas increase the amount of reflected light in to the room and level out the contrasts. Splayed reveals that slope toward the interior side give improved dispersion of the light.

The position and proportion of the window opening have consequences for the daylight distribution in the room. A high position of the window results in more daylight in the back of the room and reduces the daylight level in the window perimeter giving a somewhat more even luminance distribution throughout the room compared to a lower positioned window. Increasing the window to floor area gives as expected increased daylight level throughout the whole working plane.

Glazing

An large number of glazing types with different photometric properties are commercially available. The light transmission (LT) of the window has significant influence on the quantity of daylight entering a room. The light transmission for clear glass is relatively constant for incidence angles between 0° and 50°. For angles of incidence larger than 50° the transmission decreases and approaches zero for 90° incidence angle [Button 1993].

These characteristics together with the sky luminance distribution are of vital importance for how much light reaches the working plane in a sidelighted room under overcast sky conditions. The luminance distribution must be combined with the light transmission of the glazing for the different angles of incidence. A point in the working plane in an unobstructed sidelighted room will receive varying quantities of daylight from the different sky sectors. If the total quantity of daylight received on the inside of the window is 100%, the percentage contribution of daylight from the different sky sectors are expected to be as shown in Figure 2-5. The values are estimated using daylight protractors for clear double glazing [Löfberg 1987], and refer to a point on a horizontal surface and sky with luminance distribution

according to the CIE overcast sky. The figure 2-5 shows that largest contribution of daylight near the window opening is received from the angular sector around 60° of elevation.

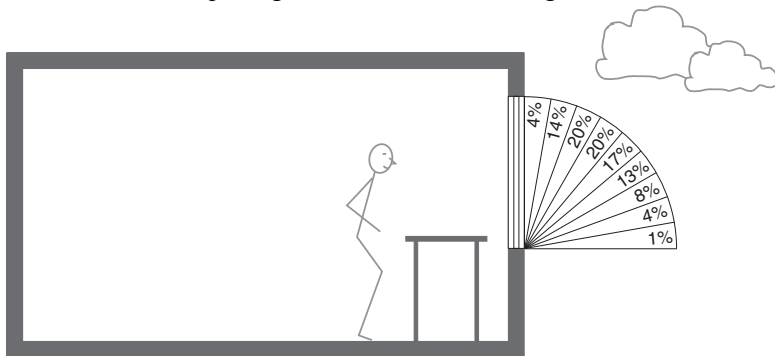

Figure 2-5. Illustration of percentage daylight contribution from the different 10 degree sky sectors.

Room design

Proportions

The height of the upper edge of the window is of vital significance for deciding acceptable room depth of a sidelighted room, while the window area is of secondary importance. According to Littlefair [1991], in order to avoid a gloomy looking rear part of the room, the room depth, L should not exceed the limit value expressed by the following equation:

$$\frac{L}{W} + \frac{L}{H} \leq \frac{2}{1 - R_b}$$

where W is the room width
 H is the window head height above floor level
 R_b is the average reflectance of surfaces in the rear half of the room

A high window head increases the exposure to the sun and brighter areas of the sky, which increases possibilities for visual discomfort and need for solar control elements.

Material properties

Most of the light reaching the rear part of a sidelighted room is the reflected light from surfaces near the window. The surface reflectance factors are consequently of vital importance for the daylight levels in the inner part of the room.

2.4 Daylight requirements

The Norwegian Planning and Building Act [Planning and Building Act 1986] with the associated Technical Regulations [Technical regulations 1997] states that:

§ 8-35 Light

All rooms shall have satisfactory lighting without unpleasant heat load. Rooms for permanent occupation shall be provided with daylight, unless the dwelling or working situation should indicate otherwise.

§ 10-33. Lighting and view

Every room should have adequate lighting in relation to the room's function and user needs. Rooms for permanent residence shall have windows and views. For some rooms, this can be facilitated by adequate openings to other rooms or skylights. Where special circumstances make it necessary can windows be replaced with well-arranged lighting.

The demand is associated with the admission of daylight, based on the environmental and health aspect of daylight.

The guidance to Technical Regulation [Technical regulation, guidance 2007] confirms that daylight is the form of lighting that is experienced as the best and most correct ambient lighting. Rooms for permanent stay should have satisfactory daylight and view to the outdoor. The guidance confirms that the demand is fulfilled if:

The average daylight factor in the room is minimum 2 %.

Control of the daylight situation can also be carried out in accordance with the Swedish Standard SIS 914201 “Byggnadsutforming – Dagsljus – Förenklad metod för kontroll av erforderlig fönsterglasarea [SIS 914201]. The standard states a demand to minimum window glass area to floor area as a function of the obstruction angle.

Satisfactory view is achieved when windows prevent cooped up feelings and gives the occupants contact to the outside from both sitting and standing positions. The view towards greenery and water is preferred.

2.5 Design strategies for daylight in buildings

The main function of a window is described in section 2.3. As described earlier, working places in side lighted rooms may be exposed to visual problems associated with glare, non-uniformity of lighting, low lighting levels, as well as thermal discomfort.

Sunlight in the field of view might cause glare problems either as direct radiation or as reflected light from another surface, as in

Figure 2-6. High luminance on the sky vault is another source of glare problems. Large luminance variations due to the non-uniform daylight distribution throughout the working plane can result in fatigue of the adaptation processes, and low daylight levels in the inner part gives unsatisfactory task lighting. Unilateral daylighting may also cause unsatisfactory modelling capabilities. In addition, exterior obstructions may reduce the daylight to unacceptable levels.



Figure 2-6. Reflected sunlight from a solar shading device causes glare problem in a north-oriented office in the opposite building.

Consequently it is desirable to improve the visual conditions in a side lighted space by:

- Increasing daylight levels in the rear part of deep spaces

- Providing better visual comfort by reducing glare problems
- Controlling and utilizing sunlight so it can be an effective illuminator
- Increasing the quantity of usable daylight from windows (blocked by external obstructions)
- Maintaining the access to outside view
- Improving daylight uniformity across a space

Control systems, smart windows and daylighting systems are technological concepts that can contribute to reach some of these objectives. Daylighting systems can consist of special types of glass, reflectors or other optical systems which reject, scatter or redirect the daylight in controlled directions.

3 CONTROL SYSTEMS AND SMART WINDOWS

3.1 Control systems

Daylight harvesting and integrated control strategies can reduce the energy use for lighting in buildings. Control systems are discussed thoroughly in a separate report within the ZEB [Mathisen 2009], therefore, only a brief overview is given here.

Daylighting alone, even if distributed with the help of daylighting systems, cannot secure adequate lighting conditions for all working hours during a year and for all visual tasks. It is due partly to the limited availability of daylight during the year, partly because it is difficult to redirect diffuse daylight precisely to the desired place. Artificial lighting is much more flexible; it should supplement daylight in the periods of time when daylight level is too low or in places where a specific distribution of light is desired.

Many new fluorescent light sources developed in recent years both have a high efficiency lm/watt and a high color rendering, making them attractive supplements of daylight. They have a longer live span than their predecessors. The electronic joints reduce the danger for flicker.

The most promising new technologies in lighting are Lighting Emitting Diodes (LEDs) and Organic Lighting Emitting Diodes (OLEDs) [Jonson 2002]. The form of OLED sources can be quite different from current sources, allowing exciting new design solutions and applications. Being diffuse sources, OLEDs are much lower in intensity per unit area than LEDs. The manufacturing process for OLEDs lends itself to shapes that can be formed to different geometries, making luminous panels or flexible luminous materials possible. Conversely, LEDs are very intense point sources which can be integrated into small spaces to create an intense source or used separately for less focused applications. High efficiency (lm/watt) is one of the most important attributes motivating scientists to work with LEDs. Another is that they produce electromagnetic radiation only in the visible part of the spectrum; i.e. they do not produce radiant heat. Both OLED and LED sources are expected to be thinner than other comparable sources; the compact size offers additional design opportunities.

Many different control systems were developed to manage the artificial lighting systems depending on the daylighting level and the presence of occupants at working places. Most systems are optimized for energy saving. Two main concepts are actually used.

The on/off switching system switches artificial light on if the daylight level at the working place is lower than the level desired for visual task typical for the working place; it switches electrical light off if the daylighting level is high enough. The system may cause frequent on/off switching in periods when daylight level at working place varies and is close to the recommended value. To avoid this problem the system is designed with margins allowing daylight to increase or decrease more than the accurate value before the system reacts. There are many variants of switching systems; some of them switch light stepwise reducing the jump between each change in lighting intensity.

The dimming system concept relies on dimming of light flux from luminaries to the level that together with daylighting gives desired illuminance at the working place. Such systems utilize daylight to the higher degree than the switch on/off systems. The dimming systems are also more expensive, but they assure more stable visual conditions. It is not obvious that a constant light level at the working place during the day is desired by occupants.

Both systems can be supplied with switching on/off function reacting to presence/absence of occupants.

3.2 Smart windows

Baetens, Jelle, and Gustavsen, gives a State of the art review heading the name “*Properties, requirements and possibilities of smart windows for dynamic daylight and solar energy control in buildings*” Baetens [2010]. Below is given an extract about electrochromic windows from this article.

Electrochromism is the property of a device to change its optical properties reversibly if an external potential is applied, associated with ion insertion and extraction processes. The electrochromic device mostly consists of several layers. The basis is a glass or plastic covered by a transparent conducting film, i.e. mostly ITO (tin-doped indium oxide), on which one (or multiple) cathodic electroactive layer(s) are affixed. These are followed by a layer of ion conductor, on its turn followed by an ion-storage film or one (or multiple) complimentary anodic electroactive layers and another transparent conducting film.

The electroactive layers, often denoted as electrochromics, change their optical properties by switching between their oxidized and reduced form. Electrochromism may be seen as a device characteristic instead of material property. Most favorable are electrochromics that are reflecting in their colored state instead of absorbing, but this has been found very difficult and most electrochromics are absorbing. By combining different type of electrochromics, ion-storage films and ion conductors, different properties can be obtained for the device, where the modulation range, durability and switching speeds can be optimized. Many of these electrochromics are well-known today. Most important are the metal oxides, of which tungsten oxide is the most well-known, but also electrochromic polymers are applied in electrochromic windows and devices.

For detailed information about electrochromic windows it is referred to Baetens [2010].

4 DAYLIGHTING SYSTEMS - OVERVIEW

Conventional daylighting design components, i.e. fenestration systems, can normally provide adequate daylighting in the perimeter of buildings, i.e. within 4,0 m of windows or skylights. To provide daylight in a larger fraction of the building area requires one of two approaches.

The first option is to increase the fraction of the floor area that is adjacent to fenestration using architectural design strategies to alter floor plans from rectangular to reentrant forms, or by use of atria, or by stepping back upper stories of the building, etc.

The second option is to use daylighting optical systems to deliver light to building locations beyond the perimeter zone. The light transmission can be desired either horizontally or vertically through the core of a building. The daylighting techniques are often based on the use of special reflectors, louvers, baffles, reflective blinds, light deflecting materials, light shelves, etc.

Many of the optical daylighting systems require three major elements.

- First, a collection system is required to gather and redirect the available light flux, in some cases to concentrate it.
- Second, the light flux must be transmitted through a transmission system to the point of use in a building.
- Third, the light flux must be distributed in a way consistent with the end use of the lighting. In many systems several of these functions may be combined.

Through the combination and integration of one or more daylighting systems the amount of light in under-lit spaces can be considerably increased. Design of such optical systems should be optimized for the climate.

Since daylighting consists of two very different components, the diffuse skylight and the direct light from the sun that often has to be rejected, the systems can be divided in two main groups:

- Daylighting systems with shading
 - Systems which rely primarily on diffuse skylight and reject sunlight,
 - Systems that primarily use direct sunlight, sending it onto the ceiling or to locations above eye height
- Daylighting systems without shading included
 - Diffuse light-guiding systems
 - Direct light-guiding systems
 - Light-scattering or diffusing systems
 - Light transport systems

The matrix collected from Kischkoweit-Lopin [2002], Figure 4-1 to Figure 4-5, gives a clear overview of advanced daylighting systems available for the building profession. A detailed review of different daylight redirection systems are presented in chapter 6.

System		Climate	Attachment	Criteria for the choice of elements
Prismatic panels		All climates	Vertical windows, skylights	<ul style="list-style-type: none"> - Glare protection (D) - View outside (D) - Saving potential (artificial lighting) - Need for tracking (D) - Available
Prisms and venetian blinds		Temperate climates	Vertical windows	<ul style="list-style-type: none"> - Glare protection - Lightguiding into the depth of the room - Homogeneous illumination - Saving potential (artificial lighting) - Available
Sun protecting mirror elements		Temperate climates	Skylights, glazed roofs	<ul style="list-style-type: none"> - Lightguiding into the depth of the room - Homogeneous illumination - Saving potential (artificial lighting) - Available
Anidolic zenithal opening		Temperate climates	Skylights	<ul style="list-style-type: none"> - Glare protection - Homogeneous illumination - Saving potential (artificial lighting) - Testing
Directional selective shading system with concentrating HOE		All climates	Vertical windows, skylights, glazed roofs	<ul style="list-style-type: none"> - Glare protection (D) - View outside - Saving potential (artificial lighting) - Need for tracking - Available
Transparent shading system with HOE based on total reflection (→ 4.2.3)		Temperate climates	Vertical windows, skylights, glazed roofs	<ul style="list-style-type: none"> - Glare protection (D) - View outside - Homogeneous illumination - Saving potential (artificial lighting) - Need for tracking - Available

Figure 4-1. Shading systems which block direct sunlight but being transparent for diffuse skylight. From [Kischkoweit-Lopin 2002].

System	Climate	Attachment	Criteria for the choice of elements
Light guiding shade 	Hot climates, sunny skies	Vertical windows above eyeheight	<ul style="list-style-type: none"> - Glare protection - View outside - Lightguiding into the depth of the room (D) - Homogeneous illumination (D) - Saving potential (artificial lighting) (D) - Available
Louvers and blinds 	All climates	Vertical windows	<ul style="list-style-type: none"> - Glare protection - Lightguiding into the depth of the room - Homogeneous illumination - Need for tracking - Available
Lightsheff for redirection of sunlight 	All climates	Vertical windows	<ul style="list-style-type: none"> - View outside (D) - Lightguiding into the depth of the room - Homogeneous illumination - Saving potential (artificial lighting) - Available
Glazing with reflecting profiles (Okasolar) 	Temperate climates	Vertical windows, skylights	<ul style="list-style-type: none"> - View outside (D) - Glare protection (D) - Lightguiding into the depth of the room (D) - Homogeneous illumination (D) - Variable solar heat gain coefficient - Available
Skylight with Laser Cut Panels 	Hot climates, sunny skies, low latitudes	Skylights	<ul style="list-style-type: none"> - Lightguiding into the depth of the room - Homogeneous illumination - Saving potential (artificial lighting) - Available
Turnable lamellas 	Temperate climates	Vertical windows, skylights	<ul style="list-style-type: none"> - Glare protection (D) - Lightguiding into the depth of the room - Homogeneous illumination - Saving potential (artificial lighting) - Need for tracking - Available

Figure 4-2. Shading systems which diffuse sunlight or redirect sunlight onto the ceiling or above the eye height. From [Kischkoweit-Lopin 2002].



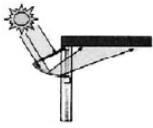
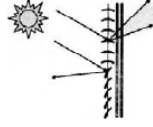
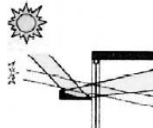
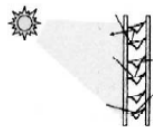
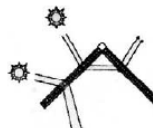
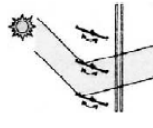

System		Climate	Attachment	Criteria for the choice of elements
Lightshelf		Temperate climates, cloudy skies	Vertical windows	<ul style="list-style-type: none"> - View outside - Lightguiding into the depth of the room (D) - Homogeneous illumination (D) - Saving potential (artificial lighting) (D) - Available
Anidolic Integrated System		Temperate climates	Vertical windows	<ul style="list-style-type: none"> - View outside - Lightguiding into the depth of the room - Homogeneous illumination - Saving potential (artificial lighting) - Available
Anidolic ceiling		Temperate climates, cloudy skies	Vertical facade above viewing window	<ul style="list-style-type: none"> - View outside - Lightguiding into the depth of the room - Homogeneous illumination - Saving potential (artificial lighting) - Testing
Fish System		Temperate climates	Vertical windows	<ul style="list-style-type: none"> - Glare protection - View outside - Lightguiding into the depth of the room - Homogeneous illumination - Saving potential (artificial lighting) - Available
Zenith light guiding elements with Holographic Optical Elements		Temperate climates, cloudy skies	Vertical windows (especially in court-yards), sky-lights	<ul style="list-style-type: none"> - View outside - Lightguiding into the depth of the room - Homogeneous illumination - Saving potential (artificial lighting) - Available

Figure 4-3. Diffuse light guiding systems. From [Kischkoweit-Lopin 2002].

System	Climate	Attachment	Criteria for the choice of elements
Laser Cut Panel (LCP) 	All climates	Vertical windows, skylights	<ul style="list-style-type: none"> - View outside (D) - Lightguiding into the depth of the room - Homogeneous illumination - Saving potential (artificial lighting) - Available
Prismatic panels 	All climates	Vertical windows, skylights	<ul style="list-style-type: none"> - View outside (D) - Lightguiding into the depth of the room - Saving potential (artificial lighting) - Available
Holographic Optical Elements in the skylight 	All climates	Skylights	<ul style="list-style-type: none"> - View outside - Homogeneous illumination - (artificial lighting) - (artificial lighting) - Available
Light guiding glass 	All climates	Vertical windows, skylights	<ul style="list-style-type: none"> - Glare protection - View outside - Lightguiding into the depth of the room - Homogeneous illumination - Saving potential (artificial lighting) - Available

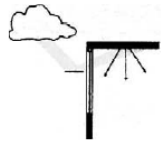
Figure 4-4. Direct light guiding systems. From [Kischkoweit-Lopin 2002].

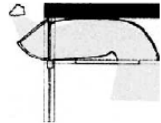
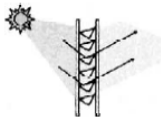
System	Climate	Attachment	Criteria for the choice of elements
Scattering systems (light diffusing glass, capillary glass, frosted glass) 	All climates	Vertical windows, skylights	<ul style="list-style-type: none"> - Lightguiding into the depth of the room - Homogeneous illumination - Saving potential (artificial lighting) - Available

Figure 4-5. Scattering systems. From [Kischkoweit-Lopin 2002].

5 DAYLIGHT REDIRECTION SYSTEMS

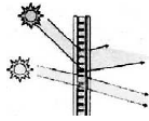
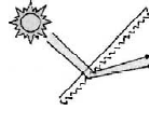
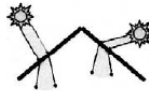
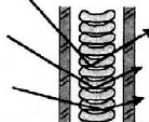
5.1 Physical and optical principles

In this chapter some of the physical and optical principles that are applied in daylight redirection systems are described. In a conventional side lighted space with vertical windows the daylight distribution is very uneven, with potentially high light levels close to the window but very little daylight deeper into the interior. This is illustrated in

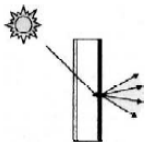
Figure 5-1.

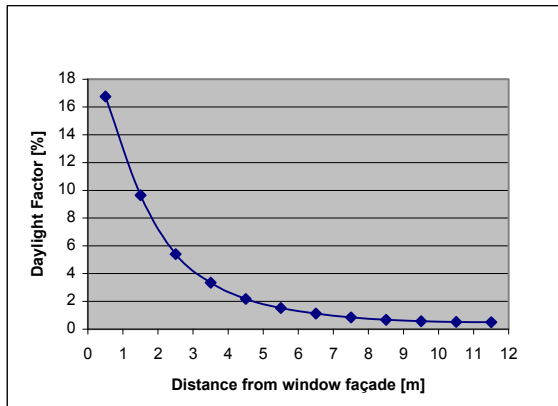

Figure 5-1. Daylight distribution on the work plane in a typical side lighted room. Computer simulations by Matusiak.

An important function of a daylight redirection system is to assure that the daylight is distributed more evenly in the interior. This is achieved by the redirection of light from the window area via the ceiling and further into the interior of the room as illustrated in Figure 5-2.

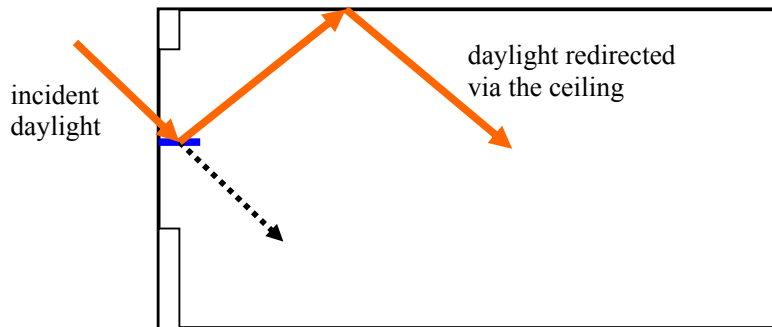

Figure 5-2. Cross-section of a side lighted room. Redirection of daylight via the ceiling can provide a more even distribution of daylight.

5.1.1 Optical principles

Daylight redirecting systems rely on the optical principles of reflection, refraction or diffraction to alter or enhance the distribution of incoming daylight. In this section the main optical principles and their importance for the performance of redirecting daylighting systems are discussed briefly.

The daylighting properties of a material can be related to what happens when light is incident onto the material.

Figure 5-3 shows a schematic illustration of this situation, with light of intensity I_i incident on a material surface at an angle θ . The light is partly reflected from the surface and partly transmitted through the sample. The transmitted light can be directly transmitted as shown in figure 5-3, or diffusely transmitted. Light that is not reflected or transmitted is absorbed in the sample.

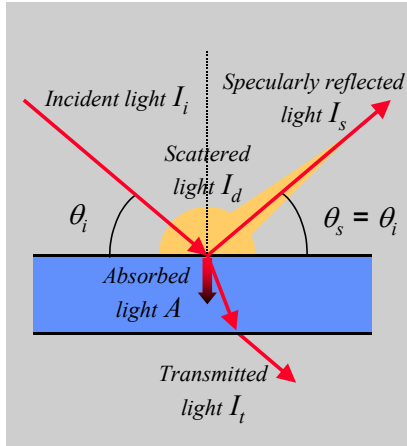

Figure 5-3. Schematic illustration of how light interacts with matter.

Reflection

Light that is incident on a surface can be reflected specularly or scattered, resulting in diffuse reflection. Specular (or regular) reflection is characterized by reflectance in the mirror direction of the incident direction; that is the angle of specular reflectance (θ_s) equals the angle of incidence (θ_i). Diffuse reflection refers to a diffusion of light where, on the macroscopic scale, there is no specular reflection. Uniform diffuse reflection is a special case of diffuse reflectance in which the spatial distribution of the reflected radiation is such that the luminance is the same in all directions in which the radiation is reflected. Most opaque materials produce a combination of regular and diffuse reflection. This type of reflection is called mixed reflection.

Total internal reflection is a special mechanism of reflection. This can occur (for oblique angles of incidence) at the boundary between materials of different refractive index. Total internal reflection can only occur when light is propagating within the material with the highest refractive index. Total internal reflection is a very effective reflection mechanism in that 100% of the light is reflected. Total internal reflection should not be confused with total reflectance. Total reflectance is the total amount of reflected light (specular + diffuse) relative to the amount of incident light:

$$\text{Total reflectance, } \rho_{tot} = \frac{I_s + I_d}{I_i}$$

A material can be designed in such a way that the incident light is reflected back in the direction of incidence. Such materials are called retro-reflectors. Retro-reflectors can be produced by several different methods. One example from nature is the cat's eye. This type of reflectance mechanism is the basis for reflector discs commonly used for traffic safety.

Transmission

Light that is transmitted through the material can be regularly transmitted or diffusely transmitted. Regular transmittance is necessary to provide a clear view through the material.

Absorption

Light that is not reflected or transmitted is absorbed in the material. Absorbed light is converted to heat that is radiated from the material.

Refraction

Refraction occurs as light passes the boundary of two materials with different refractive index. For example, when direct sunlight enters a pane of glass the direction of the light within the glass will be altered by refraction. As the light exits the glass the direction will again be altered, and this time in the opposite way back to the original direction, thus providing a clear view through the glass.

Diffraction

Diffraction is a mechanism that can alter the direction of light as it passes an edge. The principle of diffraction is utilized for daylighting in so-called holographic optical elements.

5.1.2 Ceiling properties

In daylight redirection systems, the ceiling properties are an important factor that should not be overlooked or underestimated. As can be seen from

Figure 5-2, the ceiling is an important secondary part of the light redirection system because light is reflected by the daylight system towards the ceiling and into the room. Absorption of light by the ceiling will result in a reduction of the amount of daylight that reaches the deeper areas of the room. It is therefore essential for the performance of a redirection system that the total reflectance of the ceiling is as high as possible.

Equally important however is the direction of the reflected light from the ceiling. Diffusely reflected light will propagate in all directions from the ceiling, also back towards the window area. With a specularly reflective ceiling it is possible to redirect more light deeper into the interiors, as illustrated in

Figure 5-2. However, a completely specular ceiling might cause glare, and could also be considered potentially unattractive from an aesthetical point of view. Considering this, a ceiling material with minimal light absorption that provides a mixed reflectance (combination of specular and diffuse reflectance) could function well together with most daylight redirection systems.

Ceiling materials with more innovative optical properties have also been developed. A reflective ceiling surface shaped as a saw tooth can effectively redirect light from the window facade down towards the work plane. A curved surface of reflective ceiling will also affect the light distribution. A combination of these two mechanisms is the principle behind the RetroTop louver ceiling as described by Köster [2004] and illustrated in Figure 5-4.

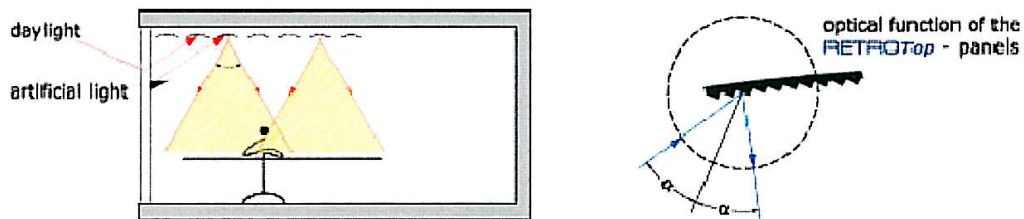

Figure 5-4. The RetroTop louver ceiling. Curved ceiling elements with a micro prismatic saw tooth structure assure improved distribution of light reflected from the ceiling. From [Köster 2004].

5.2 Daylight redirection systems

In this chapter the most important daylight redirection systems for window openings will be described, on the basis of the literature review. These systems are: (i) light shelves, (ii)

prismatic elements, (iii) laser cut panels, (iv) louvers and blind systems and (v) sun-directing glass.

Several innovative systems are not described in this report. These include the anidolic solar blinds and holographic optical elements (HOE). The main reason for the exclusion is that these systems are still on the prototype stage, and have so far not been implemented in buildings or fully tested and described in the literature. Some information about these systems can be found in [Ruck 2000].

5.2.1 Light shelves

The content of this section is primarily based on [Ruck 2000] and [Arnesen 2002].

According to Ruck [2000], a light shelf is a truly classic daylighting system that was known to the Egyptian Pharaohs. Light shelves are designed to shade and reflect light at their top surface and to shield against direct glare from the sky.

The conventional light shelf is a horizontal panel of an opaque material that is positioned inside and/or outside of the window facade. Light shelves are normally positioned above eye level, dividing the window into a view area below the shelf, and a clerestory area above. The conventional light shelf is considered most effective in direct sunlight, providing shading, glare protection and redirection of sunlight.

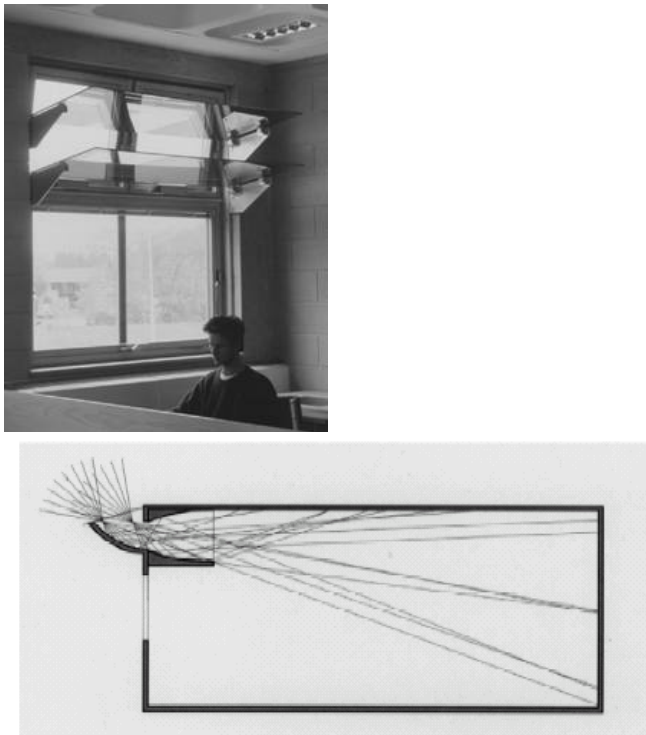

Figure 5-5. Two examples of innovative light shelves. To the left semi-transparent double light shelves made of reflective glass. Picture from [Ruck 2000]. To the right an anidolic zenithal collector. The figure illustrates the ray tracing of diffuse daylight through the system. Illustration from [Scartezzini 2002].

More sophisticated light shelves can be composed of semi-transparent materials or materials with other specially designed optical characteristics. It is also common to tilt the light shelf upward or downward to adjust the performance of the shelf. Also, the shape of the shelf can

be designed to increase performance with respect to daylight redirection. An example of a specially designed shape is the anidolic zenithal collector. It can be argued that such a collector is fundamentally different from a light shelf, but for convenience we follow Baker [2002] in considering the anidolic zenithal collector as an innovative type of light shelf. According to Scartezzini [2002], anidolic systems were developed following the principles of non-imaging optics and take advantage of these properties to achieve outstanding features for daylight collection and re-distribution.

System orientation for optimal function

As mentioned above, it is possible to tilt the light shelf to adjust the performance. The effect of this is illustrated in Figure 5-6 below. An upward tilt will increase the daylight penetration, but reduce shading. A downward tilt will increase shading, but reduce daylight penetration. According to Ruck [2000], a horizontal light shelf usually provides the best compromise between shading requirements and daylight distribution.

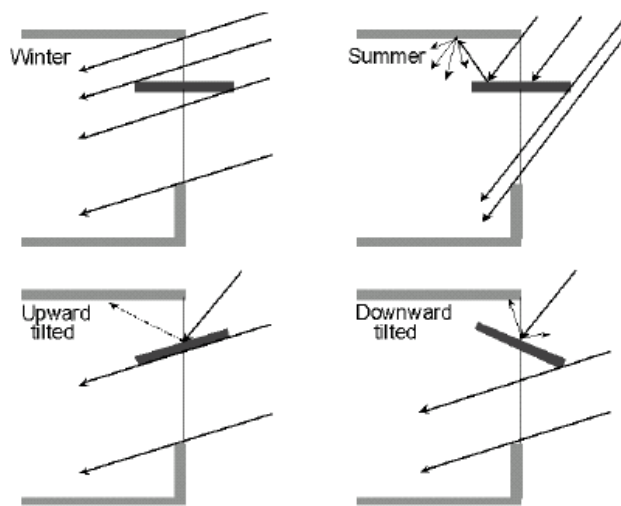

Figure 5-6. Top section shows an interior and exterior light shelf with a specular surface, and the resulting path of sunlight rays in the winter and in the summer. Bottom section shows how an upward- or downward-tilted reflective light shelf influences shading and daylight reflection. Note that, in winter, the light shelf alone does not control glare adequately. Illustration from [Ruck 2000].

Feasibility for use at high latitudes

The performance of interior horizontal light shelves at high latitudes has been tested by Arnesen [2002]. The tested light shelf was 1.0 m deep, the full width of the window, and mounted between the clerestory window (1.0 m²) and the view window (2.2 m²). The surface of the light shelf was covered with a semi-reflective, brushed aluminium sheet with a total reflectance of 72.5%. The reference room had a clear, unshaded glazing of equal size to the test room. The ceiling of the test rooms was matt white, with a total reflectance of 82%.

At overcast skies, the light shelf was shown to reduce illuminance by 20% to 35% in the whole room. Even if the light shelf reduces the illuminance in the window zone, the daylight uniformity was not improved because the reduction was also considerable in the rest of the room.

At clear skies the following results were reported by Arnesen [2002]:

Even at high sun angles in summer (53°), the light shelf does not protect areas near the window from direct sun. There is a small reduction in illuminance in the intermediate zone and a somewhat larger reduction in the rear wall zone (10–20%). In the spring and autumn,

the light shelf shades direct sun in the window zone, but it also reduces illuminance by about 25% in the rear zone. At very low sun angles in winter, the illuminance increases in the window zone, probably because of inter-reflections between the desk and the underside of the light shelf. The light shelf does not increase the illuminance in the rear zone.

According to Baker [2002], the main effect of a light shelf is to smooth the daylight factor distribution along the depth of the room. A marked decrease is observed close to the facade, while the rear zone remains unaffected. This is in contrast to the results obtained by Arnesen [2002], where the main conclusion was that the light shelf does not improve the uniformity of daylight distribution in the room.

It is however possible to improve the optical properties of the light shelf as compared to the semi-reflective surface of the shelf that was tested by Arnesen [2002]. Highly reflective and specular reflector materials for interior applications are now commercially available. For electric lighting applications, reflector materials with a total reflectance of more than 95% are commonly used. With such materials, the daylight distribution performance of an interior light shelf should, in principle, be comparable to that of an interior laser cut panel system (see section 3.3).

Also, as described in chapter 2, the ceiling is an important secondary part of the light shelf system because light is reflected by the light shelf towards the ceiling and then reflected from the ceiling and further into the room. The ceiling properties at the specific location are therefore an essential component of the light shelf performance.

Risk of discomfort glare

Light shelves are normally positioned above eye level, to avoid glare from direct sunlight reflected at the top surface. Light shelves can to some extent protect against direct glare from the sky. Combined exterior and interior shelves can be applied to prevent glare from high sky elevations. A deep light shelf will in general provide increased glare protection. Arnesen [2002] concluded that, at equinox, the interior light shelf may shade an area near the window from direct sunlight, but at low sun angles an additional shading device is necessary to avoid glare problems. With special designs such as the anidolic zenithal collector it is possible to control the re-distribution of daylight and thereby reduce glare, see Figure 5-5 (right). It is also possible to use light shelves with adjustable tilt angles for improved control of glare.

Quality of visual contact with the outside

An opaque light shelf will impair the quality of the visual contact with the outside. The position of the shelf in the window facade, the depth of the shelf and the tilt angle will all affect the quality of the view to the outside. To improve the visual contact, semi-transparent light shelves can be applied, as shown in Figure 5-5.

Potential for energy savings

The potential for energy savings with light shelves is summarized in [Ruck 2000]: Reduced light at a window wall can lead to increased use of electric lighting, but increasing the uniformity of light distribution in the same situation may cause the room to be perceived as relatively well lit, which may reduce the probability that occupants will switch on electric lights. The total amount of daylight can be enhanced by using an external light shelf, depending on the shelf's geometry and surface treatment. However, most traditional light shelves do not, in general, produce high levels of illuminance deep inside a space, so energy savings are modest.

5.2.2 Prismatic elements

Prismatic elements are made of transparent materials, usually polymers, and shaped as planar elements with a flat surface on one side and a regular patterned prismatic structure on the

other side. Prismatic elements are available either as square panels, about 10 mm thick, or as thin flexible films less than 1 mm thick [Baker 2002]. Prismatic elements are often integrated in a double glazed unit for low maintenance. Prismatic elements operate on the two optical principles of refraction and total internal reflection. Several geometries of the prismatic structure, designed for different applications, are available. The original function of the prismatic element was to redirect diffuse light from the sky zenith towards the back of a heavily obstructed room. An early version of this type of prismatic element was called Luxfer-prisms, and these were applied in Berlin as early as 1902 [Baker 1993]. The prismatic element can also be designed to reflect light from certain angles while transmitting light from other angles. This type of prismatic element can be used as a sun-shading device. The current main applications of the prismatic elements are for:

- sun-shading
 - fixed sun-shading system
 - moveable sun-shading system
- daylight redirection
 - diffuse daylight redirection system
 - sunlight redirection system

The various applications are described by Ruck [2000]. Fixed sun shading systems are designed to transmit and redirect diffuse daylight from certain directions, and to reflect direct sunlight from other directions. In this system, sunlight reflection is provided by a reflective aluminium coating on one of the surfaces of the prism, as shown in Figure 5-7 below (left). According to Ruck [2000], fixed sun-shading systems are normally found in glazed roofs. Moveable sun-shading systems reflect sunlight from a specific angle by total internal reflection, as shown in Figure 5-7 (right). For this application, the prismatic panels are normally used in louver form. The optical operating principle of light refraction can cause colour dispersion in direct sunlight. To avoid this problem, the correct profile and seasonal tilting is required [Ruck 2000].

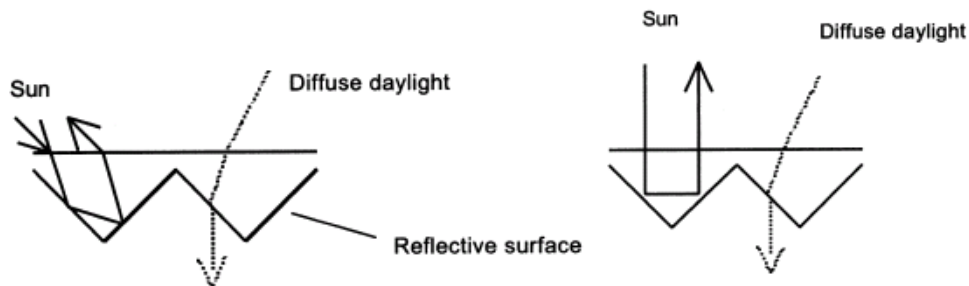

Figure 5-7. Prismatic elements as sun-shading devices. Left: Fixed sun-shading systems reflect incident sunlight from several directions by a reflective coating on one of the prism surfaces. Right: Moveable sun-shading system reflects sunlight from a specific angle by total internal reflection. Illustration from [Ruck 2000].

Daylight redirection is still an important function of the prismatic element. For this application the panels can be positioned in the vertical plane to deflect daylight deeper into the interiors, typically via the ceiling, as illustrated in Figure 5-8. In principle, the panels reduce the brightness of the windows, and therefore function as an anti-glare system [Ruck 2000]. According to Baker [2002] however, unwanted downward light beams are often produced at the same time, and these may cause glare problems in direct sunlight conditions.

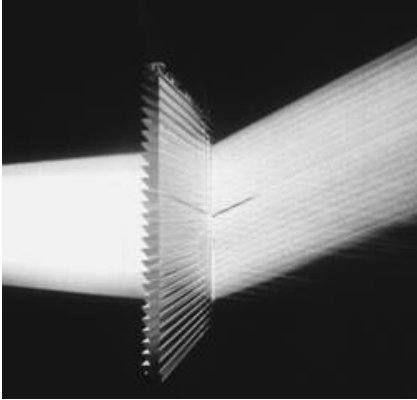

Figure 5-8. An illustration of light redirection by refraction in a prismatic panel. Picture from [Ruck 2000].

Prismatic elements are translucent and distort the view to the outside. When the elements are positioned vertically in window openings, it is therefore preferable to install the panels in the upper part of the façade opening, above a viewing window.

The light transmission through a prismatic element is quite high; it can depend strongly on the direction of incident light, but is typically about 90% for the transmitting directions [Herrmann 1999]. Based on their optical properties, prismatic elements can be said to be quite effective in redirecting daylight with low losses, both in direct sunlight as well as in overcast conditions.

Despite this, several studies have shown that in overcast conditions, prismatic elements decrease daylight factors slightly compared with a similar room with clear glazing [Ruck 2000]. Based on this it has been concluded that prismatic elements have limited applications in climates dominated by overcast sky conditions. However, simulation studies have also shown that in highly obstructed locations, prismatic systems can redirect skylight deeper into the room and therefore significantly improve daylight factors [Baker 2002]. In addition, as described in chapter 2, it should be emphasized that the optical properties of the ceiling materials are of utmost importance for the resulting daylight factors of rooms with systems that redirect daylight to the work area via the ceiling.

According to Ruck [2000], the cost of prismatic elements is in the range of 200 euros to 400 euros per square meter. This is comparable to the additional costs of sun-directing glass, as described in section 3.5.

Conclusion

Prismatic elements can be applied effectively both for sun-shading and for redirection of daylight. The overall performance of a prismatic system depends to a large extent on the appropriate configuration of refracting angles. Different geographic locations and climates require a prismatic structure that is adapted to the prevailing conditions in order to achieve optimal light distribution in the room. In addition, optimized optical ceiling properties are necessary to achieve an increased daylight factor. The potential for energy savings is largest under sunny conditions but prismatic elements can also be applied to improve daylight quality under overcast conditions.

5.2.3 Laser cut panels

The content of this section is primarily based on Edmonds [2002].

The name laser cut panel (LCP) refers to a method that has been used in the production of a powerful light deflection system. The original LCP system was developed by Edmonds [1993] and is also known as Edmonds panel. Later, light deflection systems based on the same optical principles but produced by different methods have been developed; by moulding and lamination (Serraglaze) and by extrusion (Inglas).

According to the inventor, the laser cut panel can be mounted as the primary glazing or as a second internal glazing in the upper part of a window to perform the same function as a light shelf or reflective blind system. The original Edmonds panel is produced by making parallel laser cuts to produce voids in a clear acrylic material [Edmonds 1993]. The surface of each laser cut becomes a small internal mirror which deflects light passing through the panel by the mechanism of total internal reflection. According to Edmonds [2002] the principal characteristics of the original LCP are: (a) very high portion of light deflected through a large angle ($>120^\circ$), (b) maintenances of view through the panel, and (c) flexible manufacturing method suitable for small or large quantities.

Light that passes through the panel is deflected at each surface by a sequential process of refraction, reflection and refraction. The principle of operation is illustrated in Figure 5-9a below. In the same figure we can see an important performance characteristic; the fraction of light deflected as a function of incidence angle. From Figure 5-9 b it is evident that a vertical LCP strongly deflects light incident from higher elevations ($>30^\circ$) into the upward direction, while transmitting light at near normal incidence with little disturbance, thus maintaining view. Also shown in figure (b) is the dependence of the fraction deflected on the ratio of cut width to cut depth. For large areas the cost of Edmonds panels approaches US\$100 per square metre [Edmonds 2002].

Daylighting conditions for optimal function

The principle of operation and especially the mechanism of total internal reflection assure that very little light is absorbed in the LCP. However, due to surface reflections, the amount of light that is transmitted through an LCP is comparable to an acrylic plate, about 92% or less for oblique angles of incidence. Full-scale tests with vertical LCP installed in the upper part (31%) of a window have shown that they have very little effect on the daylight factor. For clear sky conditions however, the LCP increases the illuminance levels significantly in the intermediate and rear zones of the test room, as compared to a reference room with an unobstructed window [Arnesen 2002]. The results are positive, when compared to for example a conventional blind system. The relatively good performance is not surprising, considering the superior optical performance characteristics of the LCP.

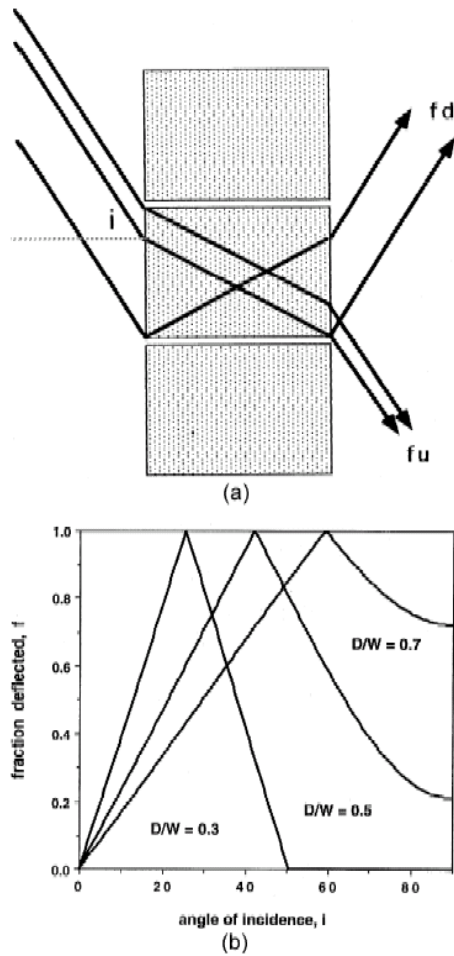

Figure 5-9. (a) The principle of operation. The sequential refraction, (total internal) reflection and refraction at the surfaces produce a deflected fraction, f_d , with the remaining fraction, f_u , transmitted without deflection. The cut spacing ratio is given by D/W . (b) The fraction of light deflected, f_d , as a function of incidence angle for LCP cut spacing ratios $D/W = 0.3, 0.5$ and 0.7 . The effect of first-surface reflection is not included in these results. Illustrations from [Edmonds 2002].

Feasibility for use at high latitudes

Due to the superior optical properties of the LCP it is a suitable daylighting system even for climates dominated by overcast sky conditions. However, as with any system that redirects light via the ceiling, the optical properties of the ceiling is of utmost importance for the performance of the LCP system in overcast conditions. Compared to an unobstructed window, the performance of the LCP redirecting system will improve with improved ceiling properties.

Risk of discomfort glare, and possibilities to avoid glare

As there are no rounded surfaces produced in the panel during the laser cutting, the amount of light scattered by the LCP is insignificant and the glare arising from the LCP itself when in direct sunlight is very low [Edmonds 2002]. However, glare can still be a problem with respect to the application of LCP. First, since the main function of the LCP is to deflect light in the upward direction, the system should preferably be placed in the upper part of a window, to avoid glare from upward deflected light. Second, due to the principle of operation, a significant part of the light is transmitted through the system without deflection. In direct sunlight this undeflected light can cause glare. One solution to reduce this glare

problem is to combine LCP with interior venetian blinds placed in front of the LCP system as described by Edmonds [2002].

Quality of visual contact with the outside

The LCP deflects light from higher elevations, but light at near normal incidence is transmitted with little disturbance. The LCP therefore preserves a relatively good view to the outside. This is a major advantage of LCP compared to several other light redirection systems, such as for example the sun-directing glass described in section 3.5.

Potential for energy savings

Energy savings are dependent on applications. External panels can increase light collection and penetration into the building. Also, the relative increase in natural light with the use of LCP compared to a conventional window will be higher in situations when the sky is heavily obstructed. As mentioned earlier, the same situations applies with LCP as with any daylight redirecting system, that the system performance to a large extent depends on the ceiling properties in the room where it is applied.

5.2.4 Louvers and blind systems

The content of this chapter is to a large extent based on [Ruck 2000] and partly on [Köster 2004].

Traditional louvers and blind systems are used primarily for solar shading, to protect against glare and for privacy. More sophisticated louvers and blind systems are designed to function as daylight redirection systems.

Louvers and blinds are normally composed of multiple horizontal slats, but also vertical or sloping slats are known. The slats can be either fixed or tiltable. Louvers and blinds can be located on the exterior or interior of a window or skylight, or between the panes of a double-paned window. In this review the focus will be on horizontal louvers and blinds applied to vertical windows for daylight redirection.

The term louvers normally refer to exterior systems. Louvers are typically made of galvanized steel, anodised or painted aluminium, or plastic (PVC) for high durability and low maintenance. The term blind normally refers to interior systems or systems located between window panes. Interior (venetian) blinds are usually made of wood, PVC or painted aluminium. The slats can be either flat or curved. Slats are usually evenly spaced at a distance that is smaller than the slat width so that the slats will overlap when fully closed. Interior slats are usually from 10 to 50 mm wide; exterior slats are usually from 50 to 100 mm wide.

Louvers and blinds are in general very flexible systems that can be useful in a number of applications and under varying conditions. A number of sophisticated shapes and surface finishes have been designed to tailor the performance of the systems with respect to daylight functionality. In the following sections six types of shading and redirecting systems will be described.

5.2.4.1 The basic daylight redirecting louver system

The simplest form of daylight redirecting louver system can be obtained by turning the slats of a conventional louver or blind system upside down, so that the concave curvature admits daylight and redirects it towards the ceiling. If it is desired to redirect as much daylight as possible, the upper surface of the slats should be highly reflective and have a relatively specular surface finish. To avoid glare, redirecting louver systems are normally located in the upper part of the window, above eye level. The slats can also be perforated to admit some daylight even when the slats are fully closed.

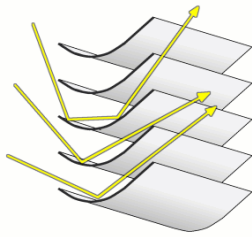

Figure 5-10. Schematic illustration of the basic daylight redirecting louver system. Illustration from <http://www.schorsch.com>.

5.2.4.2 The Fish system

The Fish system is an innovative louver system consisting of fixed horizontal slats with a triangular cross-section that are precisely aligned by means of special connecting pieces. The system is designed to redirect diffuse light, improve daylight distribution, and reduce glare. The louvers are designed so that light from the upper quarter of the sky is transmitted and directed to the upper quarter of the room (ceiling). Theoretically, the system without the glazing transmits 60% of diffuse light for an aluminum surface with a reflectance of 85% [Ruck 2000]. Considering the low transmittance, this system is not well suited for overcast sky conditions.

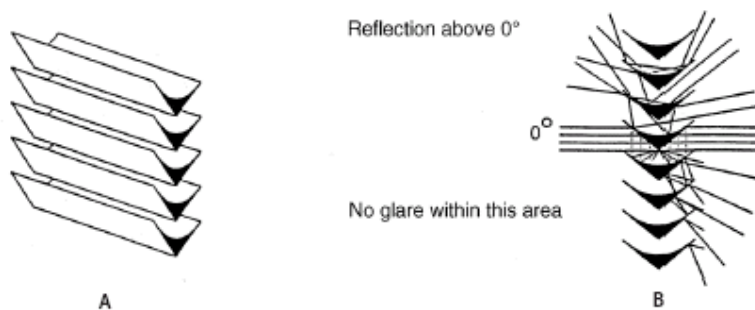

Figure 5-11. The Fish system consisting of fixed horizontal louvers. From [Ruck 2000].

5.2.4.3 The Okasolar system

The Okasolar system is also a fixed system, consisting of numerous equally spaced three-sided reflective blinds placed inside a double glazed unit. The system is designed to transmit and redirect sunlight up towards the ceiling in the winter, while high-angle light is not transmitted, giving a shading effect in the summer. These blinds are designed to suit the latitude where they will be used [Ruck 2000]. However, the operating principle of this system is not well suited for high latitudes, with the summer sun at a relatively low elevation.

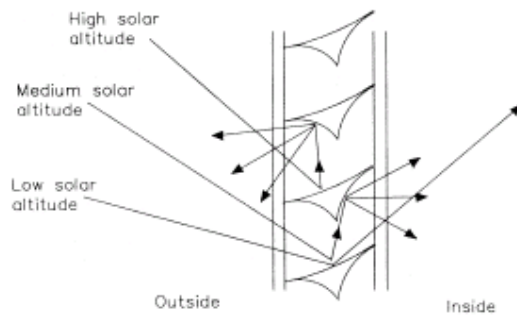

Figure 5-12. The Okasolar system consists of fixed equally spaced reflective blinds. From [Ruck 2000].

5.2.4.4 Retrolux systems

In a fixed position, the basic daylight redirecting louver system transmits daylight (including sunlight) from most parts of the sky. Fixed systems are therefore not suitable for solar shading. In Retrolux systems, the geometry of the slats have been developed to allow for fixed systems that admit low angle light, but rejects light from higher angles, including light from the summer sun. In this way solar shading is achieved also for a fixed system. Retrolux systems include exterior systems, interior systems and systems located between the panes of double-paned windows. These systems are comparable in operation to the Okasolar system, and for the same reason as given above, the Retrolux systems are not well suited for high latitudes.

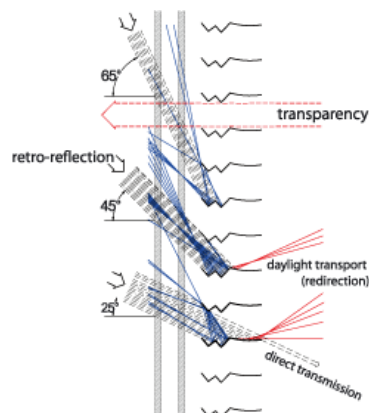

Figure 5-13. An example of a Retrolux system. The system consists of equally spaced reflective blinds in a fixed position. Due to the geometry of the slats, high angle light from the summer sun is rejected, providing solar shading. From [Köster 2004].

5.2.4.5 The Hüppe system

In the Hüppe system, conventional daylight redirection blinds are combined with prismatic blinds. The prismatic blinds can be tilted towards the sun to reflect incoming direct sunlight. This system can provide good solar shading in combination with redirection of diffuse skylight.

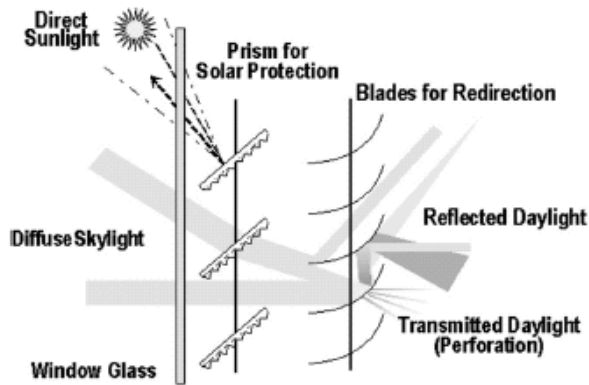

Figure 5-14. The Hüppe system for solar shading and redirection of skylight. Illustration from [Ruck 2000].

5.2.4.6 Laser cut panel system

Laser cut panels can also be applied as louvers or blinds. The example below shows laser cut panels applied between double glazing to provide solar shading and improved daylighting. A main benefit of this system is that solar shading by rejection of high elevation sun radiation can be combined with a relatively good view to the outside.

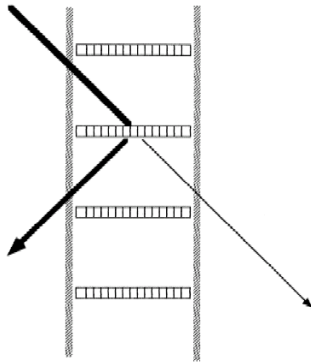

Figure 5-15. Laser cut panels applied as blinds between the panes in a double glazing. Illustration from [Edmonds 2002].

Solar shading

The ability to provide solar shading is often an important function of a daylighting system. Louvers and blind systems can be very efficient in this respect. The best results are in general obtained with exterior systems, but also systems located between window panes can provide excellent solar shading. Interior systems are in general less effective due to the greenhouse effect. However, interior systems can provide reasonable solar shading provided that the surface characteristics of the slats are optimized. For best performance, the outward directed surface of the slats should be highly reflective in the solar range (0.3 μm to 2.5 μm). In addition, it is important that the solar radiation is reflected back towards the exterior at angles that allow high transmittance back through the glazing. This can be obtained by either a specular or a retro-reflecting surface. The Hüppe system is an example of a solar shading system based on retro-reflecting interior blinds. For interior systems a diffuse slat surface should be avoided, because in this case a large portion of the reflected light would strike the pane at oblique angles and be trapped and converted to heat in the interior.

Discomfort glare

Under sunny conditions, blinds can produce extremely bright lines along the slats causing glare. With blinds at a horizontal angle, both direct sunlight and diffuse skylight can increase window glare due to increased luminance contrast between the slats and adjacent surfaces [Ruck 2000]. However, used properly, louver and blind systems are especially suitable to reduce glare. In tiltable systems the slats can be tilted to adjust the inside luminance to acceptable levels. Fixed redirecting systems are more subjected to glare problems. Such systems should preferably be located above eye level to reduce the possibility of discomfort glare.

Visual contact with the outside

Depending on the slat angle, louvers or blinds partly or completely obstruct the view to the outside. This can sometimes be desired for privacy concerns but is in most cases a negative side effect of the systems. The dimensions of the slats are of importance for the view; small-scale structures of interior blinds can sometimes obstruct the occupants perception as the eye sorts out the outside view from the blind itself. Many louvers and blinds are therefore designed to be fully or partially retractable. In most cases there is a trade-off between a good view to the outside and different other desired functions such as, for example, solar shading. Special blinds such as the Retrolux systems have been designed precisely to allow for both acceptable solar shading and redirection of daylight as well as a view to the outside. Also the laser cut panel system can provide solar shading from high angle sunlight while keeping a relatively open view to the outside.

Feasibility for use at high latitudes

Louver and blind systems are very flexible with respect to design and can be tailored to suit different performance demands. With a proper design, louver and blind systems have the potential to provide a good combination of solar shading, glare protection, redirection of daylight as well as a relatively open view to the outside. At the same time the systems can be quite compact and desirable from an aesthetic point of view.

However, most of the existing sophisticated systems are designed primarily for low or mid latitudes. The Okasolar and Retrolux systems for example, are designed on the assumption that the summer sun is incident from high solar angles. These systems are therefore not suitable for high latitudes where the summer sun in general is located at much lower angles. The tiltable systems are more flexible with respect to the solar angle, and these systems are therefore more suitable for high latitudes. This includes the basic daylight redirecting louver system as well as the Hüppe system.

Conclusion

As shown above, louver and blind systems are very flexible as daylighting systems. Different slat materials, geometries and surface characteristics can be applied to improve the function of the system with respect to daylight redirection, glare protection, solar shading and transparency. The systems can be tailored for the latitude and climatic conditions where they will be used. Moveable systems are the most flexible with respect to daylighting performance, but fixed systems with specially designed properties can be advantageous with respect to overfriendliness and maintenance.

5.2.4.7 Sun-directing glass

The main component of sun-directing glass is a stack of curved acrylic elements that are positioned between two panes of glass, comprising a sealed window unit. The acrylic elements have a higher refractive index than the gas between the panes and function as optical light guides on the principle of total internal reflection.

The acrylic elements effectively guide the incoming light from angles in the operating region of $15^\circ - 65^\circ$ towards the ceiling. The principle of operation is illustrated in Figure 5-16. In addition to this vertical deflection, the sun-directing glass also deflects the incoming light horizontally, towards the center of the room. This is achieved either by the principle of diffraction, in a holographic optical element (HOE), or alternatively by the principle of refraction, by a sinusoidal surface structure at the trailing edge of the acrylic elements.

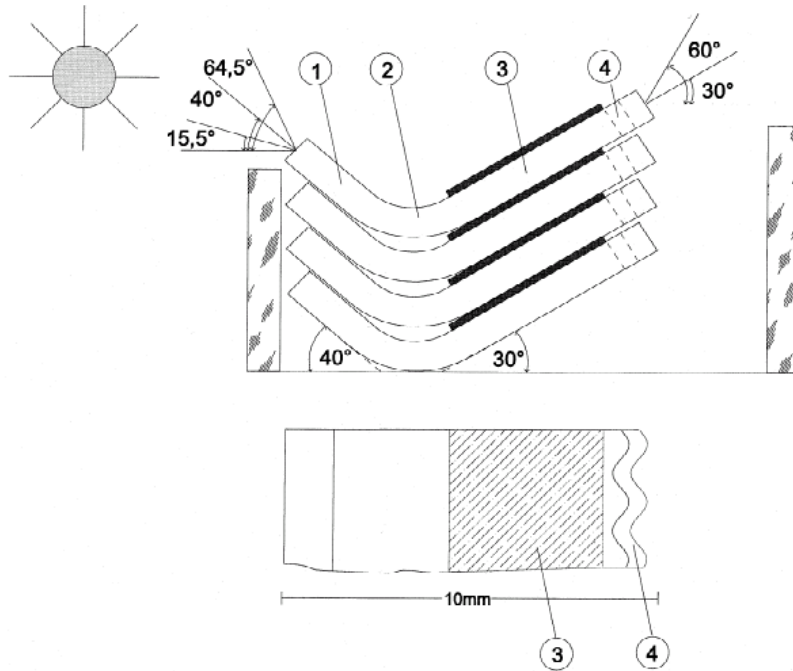

Figure 5-16. Schematic illustration of sun-directing glass. Incident light impinges onto the straight leading section (1) which is inclined at an angle of 40° from the horizontal. A curved middle section (2) redirects incident light via total internal reflection. The straight end section (3) is tilted 30° from the horizontal for illumination without glare. At its trailing edge, the end section is fitted with a corrugated strip (4), which scatters the light into the horizontal plane and also serves to redirect obliquely impinging light towards the centre of the room. Illustration and text from [Beck 1999].

The sun-directing glass is designed primarily for redirecting sunlight. Diffuse skylight will also be transmitted and redirected, but the loss of light is in this case a significant drawback. Product information supplied by LIFLITE GmbH indicates that a double glazing unit of sun-directing glass transmits about 50% of the visible daylight, whereas a conventional double glazing transmits about 80%. According to a test carried out at the Technical University of Berlin, the sun-directing glass decreases the interior illuminance levels compared to conventional glazing under overcast sky conditions [Ruck 2000].

The sun-directing glass is translucent, and does not provide a view to the outside. The system is normally positioned in the window area above eye height in order to avoid glare and to allow for an undisturbed view through the lower part of the window (viewing window). The sun-directing glass can also be placed in front of the façade, or behind it in retrofit situations [Ruck 2000].

The combination of vertical and horizontal deflection of sunlight results in a relatively uniform illumination of the ceiling, which to a large extent is independent of the position of the sun, as shown in

Figure 5-17. It is significant that this uniform distribution is achieved without any moving parts. Because of the uniform distribution of sunlight in the ceiling it is unlikely that the

deflected sunlight will cause glare. However, according to Ruck [2000], it is possible that the bright luminance of the sun-directing glass itself may be a source of discomfort glare. The luminance values with sun-directing glass have been measured and compared to values with conventional glazing [Beck 1999]. For viewing angles of less than -15° luminances are reduced significantly, but a glare-free illumination of offices with workstations cannot be guaranteed. According to Beck [1999], the sun directing element can be equipped with an optimized coating on the end section to reduce the glare problem. Personal inspection by the present author indicates that downward deflection of light occurs mainly when the sun is located outside the operating range of the system, above 65° or below 15° . Within the operating range the possibility of problems with glare seems to be of little significance.

The sun-directing glass is designed for redirecting sunlight provided that the solar angle is between 15° and 65° . In the current design, the sun-directing glass performs best at mid-latitudes. For high latitudes it would have been beneficial to tilt the acrylic elements differently to allow for efficient operation at lower solar angles. By tilting the elements 10° (counterclockwise), the effective operating region of solar angles would be from 5° to 55° . In this way the low angle (winter) sun characteristic of high latitudes could also be utilized effectively, and the possibility of discomfort glare could be reduced at high latitudes. In principle, such an adjustment of the operating angles should be easy to implement in the sun-directing glass.



Figure 5-17. Illustration of light distribution in a side-lighted space without (left) and with (right) sun-directing glass in the clerestory portion of the window. Pictures from the web-site of the company LIFLITE GmbH; www.liflite.de

The colour dispersion of daylight (rainbow-effect) typically occurs in daylighting systems based on the principle of refraction or diffraction. Since the main optical principle of the sun-directing glass is (total internal) reflection, this type of colour effect is not a problem for this particular daylighting system. In addition, the principle of total internal reflection also assures that all visible wavelengths are transmitted through the system equally well, and therefore the superior colour rendering properties of daylight are not altered by this type of reflection.

The sun-directing glass also contributes to the thermal comfort in the building. According to product information supplied by LIFLITE GmbH, introduction of the sun-directing elements in a double glazing unit with air reduces the unit's total solar gain factor (g-value) from 0.79 to 0.52, and its U-value from 2.8 to 1.8 W/m²K. For a double glazing unit with argon and low-e coatings, the g-value is reduced from 0.65 to 0.43 and the U-value from 1.2 to 0.8 W/m²K as a result of the sun-directing elements.

The improved g-values are a result of the lower transmittance of the sun-directing system; a higher part of the solar radiation is reflected back to the exterior or absorbed in the outer parts of the glazing system. The improved U-values can be explained by comparing the sun-directing system with a triple glazing system. As illustrated in Figure 5-16 (top), the sun-directing elements separate the air pocket into two isolated air pockets. In this respect, to a certain extent, the sun-directing glass can be compared to a triple glazing system.

A main drawback of the sun-directing glass is the relatively high cost. According to Ruck [2000], the price difference between sun-directing glass and standard insulating double glazing is about 200 euros per square meter. According to recent information (2004) supplied from LIFLITE GmbH the additional cost for their sun-directing glass named LIF is about 400 euro per square meter. Sun protection might not be necessary in front of the sun-directing glass, so these costs can be reduced. Also, the potential for energy savings with this system is relatively large, especially for predominantly sunny climates.

Conclusion

The sun-directing glass is a very interesting system to improve daylight quality in predominantly sunny conditions. The current geometry of the system is optimized for mid-latitudes. As a result of the vertical and horizontal deflection of sunlight, a uniform distribution in the ceiling is accomplished, to a large extent unaffected by the location of the sun, as long as it is located within the operating range of the system. Since the light on the working area is reflected from the ceiling, the optical properties of the ceiling are very important for the energy savings potential of the system. In predominantly overcast climates the low light transmittance (about 50 %) of the system is a major drawback.

5.2.5 Sunlighting collection and distribution system

An interesting sunlighting system has been developed at the University of British Columbia, Vancouver, Canada, Whitehead [2009]. It combines two structures, one for collecting sunlight and another for distributing it within the building.

The key feature of the collection system is an array of thin, approximately square mirrors that move to track the motion of the sun across the sky, Figure 5-18. The mirrors are interconnected so they can be oriented in unison using only two simple, inexpensive motors. The mirrors reflect the sunlight toward two redirecting mirrors placed directly on the façade of the building so that sunlight can be efficiently concentrated throughout most of the day. The whole collection module is protected from the weather and dirt by the canopy that may be suspended on the outside of the façade or integrated in the building (double façade design).

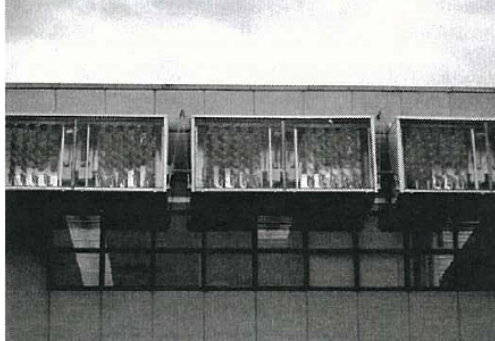
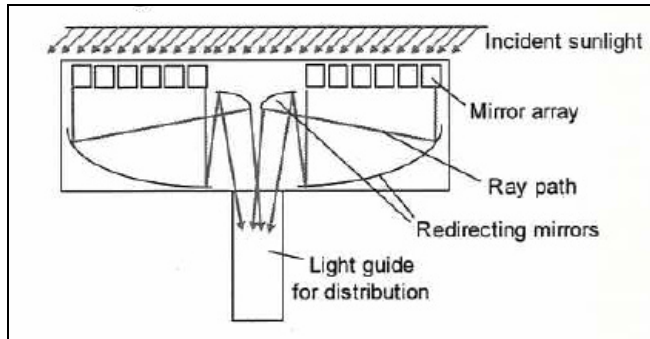

Fig. 5-18. Sunlighting collection module. The principle drawing to the left, the photo of the canopy to the right.

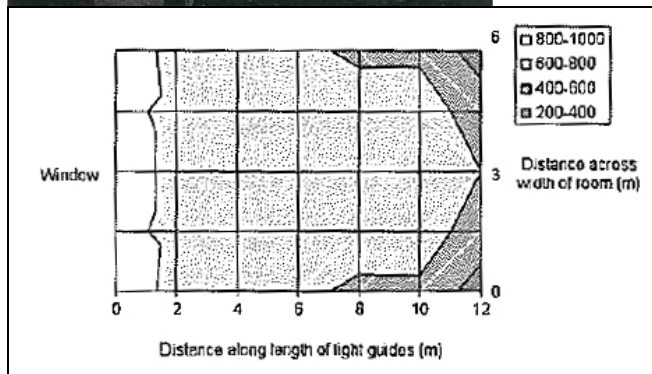
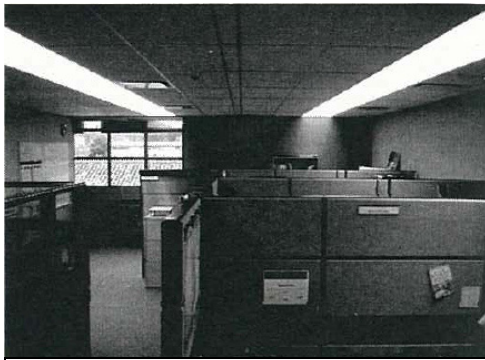

Figure 5-19. Distribution inside. The photo of the office landscape to the left, the illuminance at the horizontal working plane to the right.

The concentrated and partially collimated sunbeam is directed through the small window and into light distribution structures housed within the ceiling cavity. These specially-designed light guides with interiors lined with highly reflective material are integrated with a dimmable electric lamp system. In the first demonstration project installed in an existing

building located at the British Columbia Institute of Technology, Canada, the light guides distribute up to 65,000 lumens of sunlight over a distance of 12m, and illuminance levels provided by the guided sunlight are well above typical standard of 500lux, figure 5-19. Based on the average annual local sunshine probability, it is anticipated that this demonstration system will enable the electric lights to be turned off at least 25% of the time.

Conclusion

As a result of the demonstration system, the whole workspace, including an interior windowless meeting room, is entirely illuminated by sunlight for about six hours during the workday, whenever direct sunlight is available. The demonstration shows the potential for the technology to be cost-effective through energy savings in the climate of British Columbia that is not very different from the Norwegian climate.

5.3 Conclusions on daylight redirection systems

In this chapter, several traditional and innovative daylight redirection systems have been described. They all have their advantages and disadvantages, and the choice of system will depend on the specific requirements and conditions for each specific application. In general, adjustable systems are more flexible than fixed systems with respect to good performance under variable daylight conditions. Also, a combination of two or more systems will often provide the best daylighting performance in such situations.

Daylighting redirection systems generally perform best in direct sunlight. This is obvious because direct sunlight is the condition that is the most challenging to meet for a conventional window. In direct sunlight a conventional window can cause glare, radiant heat gain and excessive illuminance levels at the work area. Daylight redirecting systems can reduce or eliminate these problems and still admit usable sunlight and distribute it in a smart way within the interiors. In this way the daylight quality and visual comfort can be significantly improved. If the alternative is to shut out the sunlight completely, energy savings through reduction in electric lighting loads can be obtained with sunlight redirection systems.

Improved performance under overcast sky conditions is more difficult to accomplish. The main reason for this is that the conventional window often performs reasonably well under overcast conditions. However, even under such conditions glare from the sky can become a problem. This problem can be reduced or eliminated by daylight redirection systems. Another feature of the conventional window is that the daylight factor decreases rapidly with the distance from the window wall, as shown in

Figure 5-1. Experiments and simulations have shown that it is possible to improve this situation with daylight redirection systems. However, for this to be possible, the optical properties of the ceiling as well as the daylighting system need to be addressed. When comparing the performance of various systems it can be useful to evaluate and compare the theoretical optical performance of the system. For example, light shelves or blinds can in theory be made of specularly reflective materials with a minimal light absorption. Today, reflector materials with a total reflectance of more than 95% are commonly used in electrical lighting applications. Made from such materials, and with an optimized shape, reflective blinds or light shelves should in theory have the potential to perform even better than interior laser cut panels with respect to redirection of diffuse skylight. This conclusion can be drawn by considering the fact that an acrylic plate will transmit approximately 92% of the light due to surface reflections. It is however also possible to improve the transmission performance of a laser cut panel, by incorporating it between the window panes and in physical contact with one of the panes, or even by the use of antireflective surface coatings. With optimized properties of the daylighting system as well as the ceiling it has been shown that it is possible to improve daylight factors in the interior of a sidelighted room.

6 INTERACTION BETWEEN DAYLIGHTING AND OTHER TECHNOLOGIES AND STRATEGIES

The integration of daylighting systems in buildings is an obvious objective. Despite that, it is not easy to achieve in practice, because the decision about the façade design, fenestration, shading devices, BIPV, electrical lighting and control systems are made by different decision makers and at different times during the building design- and construction process. Traditionally, architects were responsible for integration of building components and systems during the design process. The technical development of daylighting-, shading- and lighting systems resulted in a huge amount of ideas, solutions and products. If an architect would still like to play a central role in the process, he/she has to increase his/her knowledge considerably. Otherwise he/she has to cooperate with specialists. The problem occurs if the advices that specialists give contradict with the main architectural concept of the building. The scenario sketched here occurs quite often, because the architects usually have very strong opinions about the design of the building façade.

In this chapter it is provided a discussion related to the integration of daylighting with other technologies and strategies. The integration of daylighting and electric lighting (hybrid lighting) is discussed in the next chapter.

6.1 Daylighting systems and Implementation strategies

Daylighting systems need clear implementation strategies. There exist too many examples of very smart products that will never be implemented. The implementation is even more difficult if the product cannot give economical profit. For example, the use of most daylighting systems cannot be justified by the profit from energy saving alone.

The very important arguments for the implementation of daylighting systems should be the health, well-being and productivity of occupants. Since the employees salaries are the highest outcome for most of enterprises, even a 0,5% increase of productivity during the year can give economical profit that can justify large investment costs for daylighting systems. It is extremely difficult to demonstrate the impact of light on productivity, but studies carried by Heschong Mahone Group document a good correlation between daylighting level and productivity, both in school and office buildings. There are also indicators pointing at the positive influence of daylight exposure on the production of cortisol hormone and the immune system of the body, this means that underexposure for light increases the probability for illness. More efforts are needed to document those connections and use them during the implementation process.

Another strategy for implementation of daylighting systems can rely on focus on an increased daylight level in areas lying away from daylighting openings, resulting in increased functionality and flexibility of those areas.

6.2 Daylighting systems and Environmental criteria

The light-transmitting daylighting systems are constructed of window glass, mirrors, acryl panes, small plastic elements etc. The light-reflective daylighting systems are made of highly reflective materials as polished aluminum and steel. As such they are not less environmental friendly than glass-façade or glass-roof systems, usually used in buildings.

Daylighting systems can give huge environmental profits by saving energy consumption for lighting in buildings operating at daytime.

6.3 Daylighting systems and Indoor environment

Daylighting systems produce no air pollution. Thus, they have no direct impact on the indoor air quality. However daylighting systems fixed inside a room having horizontal elements will increase the shelf factor in the room. If not cleaned very often, they will collect dust. Even vertical inside shading systems, e.g. curtains, collect some dust and may not be acceptable in rooms with very high demand for hygiene.

Lighting systems, if not cleaned regularly, can cause combustion of dust and unwanted pollution of the indoor air. Therefore, the lighting fixtures should be designed for quick and easy cleaning.

Some light sources make noise. Users may find it irritating.

Even more important is the pulsation effect of some fluorescent light sources. For very sensitive people it will cause headaches and for very few even epileptic attacks.

The indoor environment should include the visual environment as one of the important criteria. The glare, both from the sun, the sky and from lighting fixtures, can occur if lighting designers do not pay enough attention to shading the occupants from direct view towards light sources. The glare, especially the solar glare, can be very dangerous, since it can damage retina, the most important part of the human visual system. Most occupants will evaluate an even lighting distribution in a room as boring and flat. To increase the visual interest, the luminance distribution in the room should vary. The visual task should have higher luminance than surfaces lying close around it. The luminance of light sources should not be higher than the value 20-40 times luminance of the visual task. The recommendations for maximum luminance contrasts in the working places are worked up by the international lighting committee CIE and should be followed by lighting designers and architects.

Jennifer Weitch, the author of CIE report "*Principles of Healthy Lighting*", points to the non-visual effects of light on human physiology, mood and behavior. According to Weitch [2003], the daily dose of light received by people in Western countries might be too low. To improve the occupant's mood and make the indoor visual environment healthier for the occupants, higher lighting exposures or/and a longer period of lighting exposure will be recommended in the future. She also points at the spectrum. Light for biological activity should be rich in the regions of the spectrum to which the non-visual system is most sensitive. The exact spectrum is not known, but it peaks in the blue-green region. If so, the blue skylight should be extensively used in buildings. The report concludes that a revolution in lighting recommendations is to come within the next 10–15 years, as we expand from purely visually-based recommendations to new ways of thinking about lighting. People need enough lighting exposure and periods of darkness, too.

6.4 Daylighting systems and Building integrated energy systems

Lighting is a major electricity load in most commercial buildings. The lighting is also a major contributor to the cooling load. For commercial buildings, which are occupied during daytime, the peak lighting load typically coincides with the peak solar gain, cooling load and peak casual gains from buildings activities.

6.5 Daylighting systems and Building integrated photovoltaic

There are many examples of PV integration in buildings façade design and in fixed shading devices. In low latitudes the solar shading consists of horizontal elements placed at the top of the window or covering the window surface. Since the elevation angle of the sun is rather

small, shading elements have to be sloped slightly down from the horizontal plane allowing penetration of the diffuse skylight from the lower part of the sky; the view out is only partly obstructed.

A typical problem with shading in high latitudes is caused by low elevation angle of the sun over the horizon, especially during the morning and evening hours. To shade windows properly with the shading system made of horizontal slats, the slats have to be inclined nearly vertically, covering nearly all window area. The view out is totally obstructed; the daylight does not penetrate to the building and occupants use artificial lighting to compensate for very low lighting level. It is ridiculous; artificial lighting is used during daytime with sunlight!

Imagine a shading system consisting of vertical, moveable lamellas. An intelligent control system changes position of lamellas during the day turning them to position perpendicular to the sunlight direction. Such lamellas, always oriented toward the sun, should be an excellent place for integrating of PV! (Apart of the fact that one lamella will shade the neighbor one under slant incident angles of sunlight). The shading system sketched here will effectively shade the window and reduce the solar glare problems; it will also enable skylight penetration during most part of the sun hours and it will produce electricity. A part of this electricity can be used for operating of the system.

Another possibility for integration of PV in shading devices is to use them at the roof of the building, on the shading devices needed for skylights or glass roofs. The principle could be similar. A dynamic shading system, functioning as a moving sun umbrella, can be utilized for fixing of PV.

6.6 Daylighting systems and Heating, cooling and ventilation systems

Utilization of daylight as lighting of working areas may result in significant savings in electricity consumption for lighting. Danny [2001] reports about 50% energy savings for lighting in a single person offices were a daylight responsive dimming system is used. The energy saving potential is mostly dependent on the daylighting level in the room, the energy saving potential is much larger in the perimeter zone than in a core of the building.

Athienitis [2002] reports that in rooms with shading-, daylighting-, and dimming- control, the energy saving for lighting may exceed 75% for overcast sky and 90% for clear sky with sun, comparing to the case of no control system. The results refer to a small office room with a motorized shading system consisted of highly reflective blinds between the two panes of glass. The control system adjusts the sloping of shading blinds that control the light flux penetrating to the room and redirect sunlight to the ceiling in sunny days. It also adjusts the light flux from luminaries to meet 500 lx requirement at the working area using the dimming principle. The author claims that the control system creates high quality indoor environment too. The reduction of luminaries' operation time causes the reduction of the intern heating and increasing of energy requirement for heating. The energy saving for cooling is not documented in this study, but most probable it will be much higher than additional energy use for heating.

Sala [1996] reports about the AIW-Active Intelligent Window designed to exploit solar radiation, outdoor air temperature and relative humidity to provide automatically controlled direct or indirect solar gains, cooling by ventilation, humidification-de humidification, variable insulation and daylighting of indoors. Each function or set of functions is automatically selected by an intelligent control system.

6.7 Daylighting systems and Heat pumps

The energy consumption for lighting has an impact on the total energy consumption in buildings, also buildings heated by heat pumps. Lighting systems that utilize daylight as lighting source use less energy (for lighting) than conventional lighting systems, because the total operation time for artificial lighting is shorter. If lighting fixtures operate in shorter time, they produce less heat and the requirement for heating increases. The heat pump has to produce more heat so the effectiveness of the heat pump will probably be higher.

6.8 Daylighting systems and Operation and automation

Many intelligent control systems for lighting are under development. In addition to the daylight responsive dimming- or on/off- switching systems optimized for energy saving, new approaches focus more on occupant's satisfaction. Really, the user acceptance of automated control of daylight and artificial light is a crucial objective of any control system. One of the most important conclusions of visual comfort study, conducted by Velds [2002], was that the lacking possibility to overrule the control system was the most important complain.

Guillemin [2002] writes about a shading control system that can operate in two different ways. If the occupant is present, priority is given to visual comfort; if the occupant is absent, priority is given to thermal aspects, i.e. energy saving for cooling or heating. It is also integrated in an optimized global controller. The artificial lighting controller is used to complete the illuminance level in the room up to the level desired by the user. The desired level is learned by the system through the user's wishes.

Garg [2000] reports about smart occupancy sensor that was proposed for "human movement" of a person working at a computer and can learn the variation in activity level of the occupants with respect to the time of the day. It adapts the time delay, i.e. the time after which the lights will be switched off. Traditional occupancy sensor enables ca. 30% of energy saving for lighting compared to situation without any sensor. The smart sensor can save additionally 5%.

Kolokotsa [2001] reports about a new integrated control approach. The air quality, the thermal comfort and the visual comfort are all controlled by fuzzy logic control system. The system monitors also energy consumption for heating/cooling and electric lighting.

The pilot study about office workers response to automated venetian blind and electric lighting system carried by Vine [1998] raised a number of interesting issues with respect to occupant responses and preferences in daylighted environments.

- First, most workers appeared to prefer greater illuminance levels (more daylight and more electrical light) for their office space, even though they could see well enough to perform their tasks. The higher illuminance levels may indicate the preference of: more daylight, less-obstructed view out, for balancing the illuminance from daylighting, for more electric lighting to brighten the sides and back of the room.
- Second, even if the automated system performs well and has a high level of acceptance, occupants should be offered the ability to manually control some or all of the system operation and should be educated and trained about the proper use of the controls and the nature of the feedback system.
- Third, a large sample of people should be investigated to find answers for following questions:

- what kind of people need to control their lighting environment,
- how this control may influence their reactions to the lighting environment
- what proportion of the population prefer lighting conditions that change over time, corresponding to changes in the external conditions

6.9 Daylighting systems and Energy storage

The energy for lighting is most needed in the periods of low daylight level outside, i.e. in periods when the possibility for electricity production at site, e.g. from PV, is not possible. There is a need for energy storage if an on site energy production is to be chosen.

7 HYBRID LIGHTING

Hybrid lighting is the integration of daylighting and electric lighting into a self-contained system. So far, there have been developed very few solutions which integrate daylighting with electrical lighting within a single system.

The process of integrating daylighting and electric lighting started when new daylight-redirecting components and materials were made available to the market (e.g. Siteco, Hüppe, Edmonds, Serra Glaze, 3M). The architect had to compose these components and materials into a tailored lighting system that suited the application, as shown in figure 7-1.



Figure 7-1. Hüppe Daylight Technology

The solutions are usually optimized for direct sunlight and have a limited efficiency when the sunlight is not available. The use of such systems is limited to the countries where the probability for sunlight radiation is much higher than 50% of all daylight hours during the year. The systems are often comprehensive and require major changes in the building structure if used in existing buildings. They function well, but they often lack the economic dimension, which prevents a broad commercial support.

One very promising integrated system, designed for usage in offices, was developed by Siteco, Lighting Technology GmbH [Nagel], see figure 7-2. The Siteco Light shelf is primarily intended for installation in the top section of the window. Below the shelf, a conventional window allows for an unimpeded view of the outside. Sunlight is collected by a light concentrator and directed onto a diffuser together with diffuse skylight. The light is further directed onto the ceiling. Workplaces are illuminated indirectly with the light reflected from the ceiling. The shelf is primarily marketed as a shading device. The solar glare from the upper part of the window is avoided since direct sunlight falling on the small area of the window is distributed on a large area of the ceiling. The shelf is meant to replace the conventional ceiling mounted artificial lighting in a cell office.

The artificial lighting component is a ceiling washer mounted in the body of the light shelf above the daylight diffuser. Depending on the illuminance requirement, the washer is fitted with one or two T5 light tubes. An integrated light control system permits adjustable dimming, and thus an energy efficient operation of the lighting system. The shelf is meant to replace the conventional ceiling mounted artificial lighting in a cell office.



Figure 7-2. The Siteco Light shelf.

Apart from the Light self of Siteco, we are only aware of one other compact hybrid lighting solution that has been developed by Iguzzini. It requires a light collector on the outside of the façade and an opening in the façade. The concentrated sunlight is being reflected towards an anidolic mirror. The reflected light from this mirror is directed towards the working place through a translucent diffuser. The company intends to integrate an artificial light source in the system. To our knowledge the product is not yet commercially available [Casalone 2001] (figure 7-3).

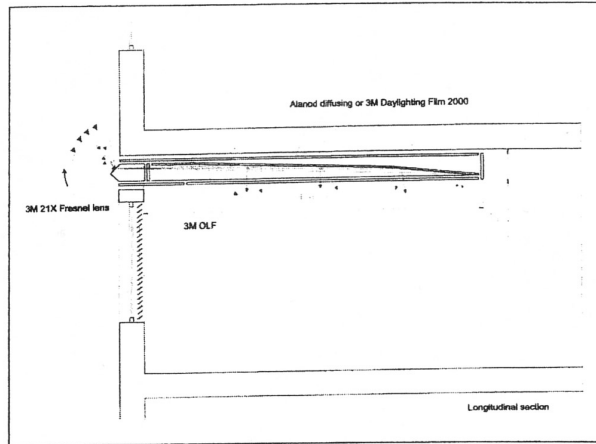

Figure 7-3. The Iguzzini hybrid lighting device.

Integrated daylight/electric light fixtures were developed both for sidelight and skylight. Two examples of integrated lighting system that combine sunlight, collected on the roof and distributed by a huge light tube, with artificial light source placed at the bottom of the building in a single package that allows the most effective delivery of both types of light, figure 7-4 and figure 7-5.

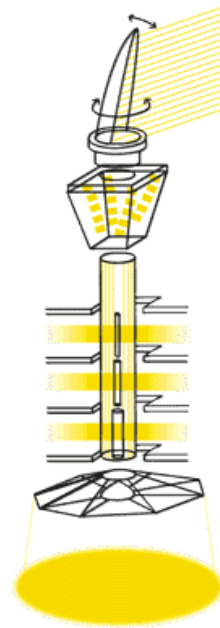

Figure 7-4. Heliobus

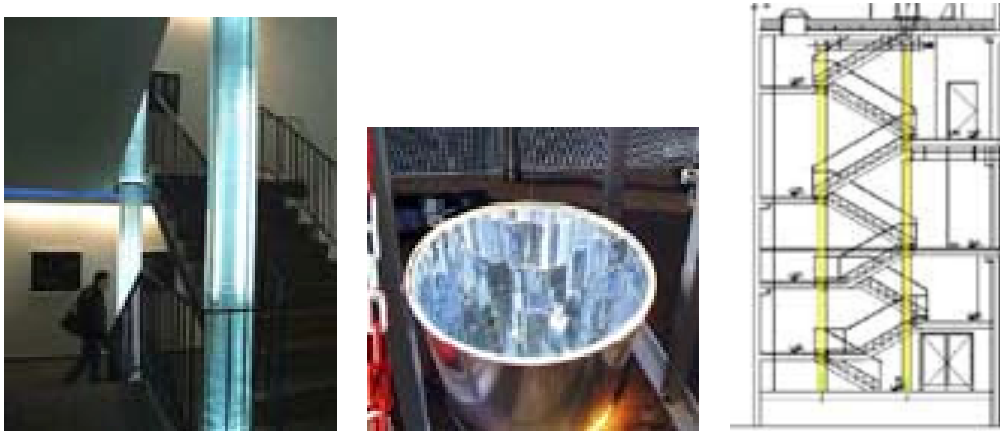

Figure 7-5. Arthelio Project

The integration of lighting and daylighting systems in one system operated by lighting control system could reduce the construction and operation costs. Nevertheless, as mentioned earlier, only a few attempts have been made to integrate daylighting and artificial lighting into a single system or a single fixture. Some explanations for this are:

1. Lack of expected economical profit. The development in the field of artificial lighting sources has resulted in many new energy effective products. The profit from energy savings for lighting can not justify the construction costs connected to the daylighting system, especially in Norway as long as electricity prices are low.
2. Lack of cooperation. Daylighting system is a part of façade design and could be designed by architects; artificial light is a part of electrical installation designed by electrical engineers. The integration needs a close cooperation between those two parts during the whole building design process. It seldom occurs.
3. Lack of manufacturers willing to develop combined daylight/artificial light system and put it on the market. Designers/producers of daylighting systems work hard to sell daylighting systems; most of them have no economical potential needed for development of complex systems. Producers of luminaries are mostly interested in production of luminaries alone; they are not willing to develop products that involve façade design.

8 ECONOMY AND MARKET

8.1 The cost of lighting

As shown earlier in this report, daylight harvesting can be achieved by many different means. As indicated in Figure 8-1, the costs for the light provided by different types of daylight harvesting systems and electric lighting systems varies greatly [Fontoynt 2009]. It should be emphasised that the given costs are calculated for a building located in France, and the costs in Norway might vary somewhat from this. The various techniques are compared on the basis of illumination delivered on the work plane per year over long time periods. The selected daylighting techniques given are: roof monitors facade windows, borrowed light

windows, light wells, daylight guidance systems as well as off-grid lighting based on LEDs powered by photovoltaics. The electric lighting installations given are; fluorescent, tungsten and LED.

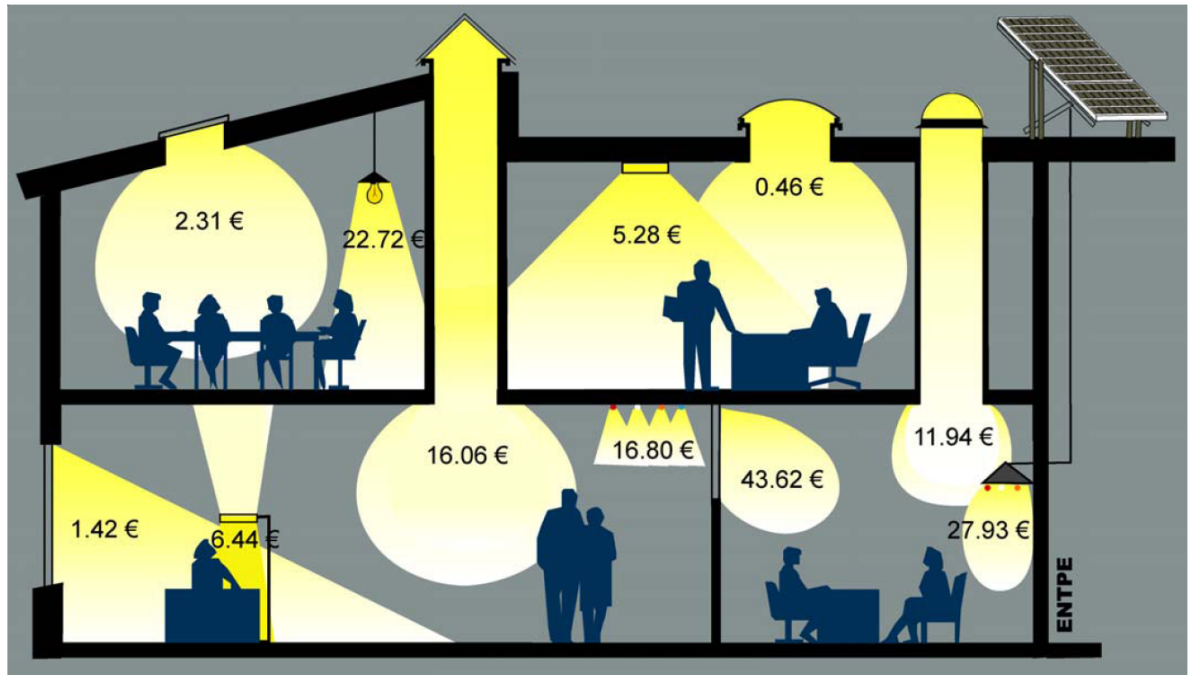

Figure 8-1 Cost of providing light on the working plane by different means. The cost includes the cost of initial construction and operation/maintenance for the expected lifetime of a building prorated on an annual basis (€/Mlmh). (Fontoynt 2009).

The least expensive means of providing daylight is achieved for top floors through the roof. It is interesting to note that this way of providing lighting is much less expensive than electric lighting. A recent overview of this technology is provided by Kim [2009].

Daylight through vertical window openings can be provided at a somewhat higher cost, but still lower than the cost for electric lighting. Daylight provided in this way is limited to the perimeter areas of the building. To be able to utilize daylight further from the window wall, daylight redirection systems can be used in the window facade. These systems typically redirect incident daylight to the deeper interiors via the ceiling, as discussed in chapter 5.

The energy savings from daylight harvesting depend on several factors, such as the type of daylighting system, building location and orientation, etc. For daylight through windows, the saving potential also depends strongly on the type of solar shading used and on the operation of the solar shading. Assuming that the solar shading is operated to prevent glare and overheating, the two most important factors determining the daylight harvesting potential through windows is the size of the window relative to the perimeter floor area and the light transmission properties of the window. A simplified model for the lighting energy saving potential has been developed by Krarti [2005]. He defines the *daylight aperture* as the product of window to perimeter floor area and window transmittance. For small daylight apertures the energy saving potential increases almost linearly with window area and window transmittance.

8.2 Barriers for use of daylighting systems

The systems presented in Figure 4-1 to Figure 4-5 represent a large range of advanced daylighting systems now available to the building profession. Some of these systems are in the development or prototype stages and some systems are architectural concepts rather than products.

Unfortunately, daylighting systems are generally seldom used in real buildings. There are many reasons for this:

- The high price of materials used in the systems, e.g. laser cut panels, prismatic panels, specular reflectors having very high reflectance, etc.
- Necessity for supplement with electrical lighting system. The daylight system alone cannot meet the lighting demand during all operation hours, it has to be supplemented with artificial light system, but the construction cost of artificial lighting system is much higher than the energy saving for lighting due to usage of daylight during many years.
- Lack of standard designs and products/systems optimized for specific latitudes and climates on the market.
- Lack of integration between daylighting and other building components.
- Lack of scientifically documented results confirming the positive impact of daylight on productivity.
- Lack of information for building developers and investors about the importance of daylight for health, and well-being.

The usage of daylighting systems in buildings should be justified by increased daylight level in under-lit areas, better visual environment and health and well-being of occupants. The energy saving for lighting is not strong enough argument for most of private investors.

8.3 Stakeholders attitudes towards daylighting systems

The following section discusses the authors' subjective experiences with the different stakeholder's attitude towards daylighting systems.

The Government is concerned about employment, economic growth, environmental concerns and the country's dependence on import. Any system that contributes to energy saving and occupants health/well-being is politically interesting.

Architects: are generally very positive to a smart integration of different systems in buildings. Most architects know about the positive impact of daylight for human health, well-being and productivity. Those aspects make them positive to daylighting systems as long as the system looks attractive aesthetically. They love glass for its transparency and they like to design buildings with large glazing areas, both on facades and on the roof. They may be skeptical to the systems placed on the façade, e.g. shading systems that are in conflict with the transparency of the building. Architects are very concerned about the aesthetics and design of products, e.g. lighting fixtures have to look aesthetically attractive and trendy to be chosen by them. They are also concerned about function ability of building areas. They are positive towards the integrated lighting systems that enable more flexible utilization of floor areas. In addition they are under a constant pressure from buildings owners to design buildings with large floor area/volume coefficient.

Electrical engineers: do not know much about daylighting systems or shading systems, but they are familiar with control systems for electrical lighting. Due to very limited budgets for lighting projects they prefer to use standard products and solutions.

Contractors generally do not know much about daylighting systems. They are even more conservative than engineers, new solutions and new systems introduce new risks to them. Electricians who are responsible for installation of the electrical systems on-side are mostly concerned about easy montage.

Investors should be divided to:

- investors who construct buildings in order to rent or sell them
- investors who rent

The main goal for the first group is to construct as much floor area as possible for a given volume of the building at the lowest possible price. A high floor area per volume factor is easier to obtain in compact buildings. They should be interested in applying a hybrid lighting system if the system will enable usage of the areas lying remote to the window wall as working areas, especially if the difference in the total investment cost is not too high. A radical increase of electricity prices will probably widen their interest in energy efficiency, as it will be easier to rent or sell the building areas that are energy efficient.

The main goal of the other group is to reduce the operation and maintenance costs, subsequently to make the working areas attractive for the occupants. They prefer flexible areas.

Any system that contributes to saving of electricity costs and at the same time is acceptable for the occupants, is attractive. Easy access to luminaries, and infrequent change of light sources reduces maintenance costs.

Occupants are mostly concerned about a comfortable working/living environment, to some degree about the quality of the visual environment and aesthetics. A nice view through the window is also of great importance for them. They also value the possibility to control their environment by themselves. If any control system is to be accepted, it has to be user friendly.

They should be better informed about the very positive effect of daylight on their health, well-being and productivity.

9 MAIN CONCLUSIONS

Daylight is a natural resource that should be harvested in order to obtain energy savings in buildings. The control and utilization of solar energy and daylight can be considered a fundamental requirement in order to obtain a *zero emission building*.

As shown in this report, daylight can be provided to the building spaces by many different technological means. It is important to realize that the cost of lighting is often less for daylighting solutions compared to electrical lighting. The least expensive means of providing daylight is achieved for top floors through the roof. But also daylight through vertical window openings can be provided at a lower cost than that of electrical lighting. This underlines the timeliness of daylight redirection systems for vertical window openings.

Other types of daylighting solutions provide daylight at a higher cost. Such systems could still be considered interesting when we also consider the other positive consequences of daylight harvesting:

Potential for reduced CO₂ emissions, increased daylight level in under-lit areas, better visual environment and health and well-being of occupants are all strong incentives for applying such daylighting systems in a *zero emission building*.

10 REFERENCES AND LITERATURE

Arnesen 2002. H. Arnesen, *Performance of Daylighting Systems for Sidelighted Spaces at High Latitudes*, PhD-thesis, NTNU, 2002

Athienitis 2002. A.K and Tzempelikos, A. *A methodology for simulation of daylight room illuminance distribution and light dimming for a room with a controlled shading device*. Solar Energy 2002

Baker 1993. N. Baker, A. Fanchiotti, K. Steemers, *Daylighting in Architecture, A European Reference Book*, James & James, 1993

Baker 2002. N. Baker, K. Steemers, *Daylight Design of Buildings*, James & James, 2002

Baetens 2010. Baetens, R., Jelle, B. P. and Gustavsen, A. Jelle, B. P. and Gustavsen, A. *Properties, requirements and possibilities of smart windows for dynamic daylight and solar energy control in buildings*. Solar Energy Materials & Solar Cells 94 (2010) 87-105

Beck 1999. A. Beck, W. Körner, O. Gross, J. Fricke, *Making better use of natural light with a light redirecting double-glazing system*, Solar Energy Vol. 66, No. 3, pp. 215-221, 1999

Bracale 2001. Bracale G., Mingozi A., and Bottiglioni S. *Performances and daylighting applications of solatube® - the tubular skylight*, LUX Europa, the 9th European Lighting Conference, Reykjavik, Iceland, June 2001

Button 1993. D. Button and B. Pye, editors. *Glass in Buildings. A guide to Modern Architectural Glass Performance*. Pilkington Glass Limited. Spain, 1993

Casalone 2001. Casalone R., and Ceregioli P. *Conception and design of a teletransport system for natural light*, LUX Europa, the 9th European Lighting Conference, Reykjavik, Iceland, June 2001

Cates 1996. Cates M.R., *Hybrid Lighting: Illuminating Our Future*, ORNL Review 29(3), (1996)

Danny 2001. Danny N.W. Li, Joseph C. Lam *Evaluation of lighting performance in office Buildings with daylighting controls* Energy and Buildings 33 (2001) 793-803

Dubin 1990. F. S. Dubin. *Integrated Building Systems: Aiding The Human Element*. Consulting/Specifying Engineer. USA, July 1990

Edmonds 1993. I. Edmonds, *Performance of laser cut light deflecting panels in daylighting applications*, Solar Energy Materials and Solar Cells, 29, 1-26, 1993

Edmonds 2002. I. Edmonds and P.J. Greenup, *Daylighting in the tropics*, Solar Energy, Vol. 73, No. 2, pp. 111-121, 2002

Ejhed 2001. Ejhed J., *Daylight qualities, Acceptance studies in the Arthelio project*, LUX Europa, the 9th European Lighting Conference, Reykjavik, Iceland, June 2001

Feldmann 1998. Feldman W., *Method using daylight and artificial light source for illumination of rooms, tunnels, rail vehicles*, German patent DE19723508, Appl. W. Feldmann, (1998)

Fontoynt 2009. Fontoynt, M.. *Long term assessment of costs associated with lighting and daylighting techniques*. [Annex 45 Newsletter 1/2009](#).

Garg 2000. Garg V. Bansal N.K. *Smart occupancy sensors to reduce energy consumption.* Energy and Buildings 32 (2000) 81-87

Guillemin 2002. Guillemin A., Molteni S. *An energy efficient controller for shading devices self-adapting to the user wishes.* Building and environment 37 (2002) 1091-1097

Guillemin 2001. Guillemin A., Mortel N. *An innovative lighting controller integrated in a self-adaptive building control system.* Energy and Buildings 33 (2001) 477-487

Heliobus. Heliobus® - an innovative sunlight guidance system, www.heliobus.com

Herrmann 1999. Herrmann, B., Rosemann, A., Aydinil, S. *Optical Characteristics of Daylighting Materials*, IEA SHC Task 21 / ECBCS Annex 29, 1999

Johnson 2002. Johnson, Stephen. *LEDs An overview of the State of the Art in Technology and Application* Light Right 5 Conference, Nice, France, may 27-31 proceedings, 2002

Johnson 2002. Johnson, Stephen. *The solid State Lighting Initiative: An Industry/DOE Collaborative Effort* Architectural Lighting Nov/Dec 2002

Kim 2009. Kim, J. T. and G. Kim. "Overview and new developments in optical daylighting systems for building a healthy indoor environment." *Building and Environment* 45(2): 256-269 (2009).

Kischkoweit-Lopin 2002. Kischkoweit-Lopin, Martin. *An overview of daylighting systems.* Solar Energy, Volume 73, Issue 2, August 2002, Pages 77-82

Kolokotsa 2001. Kolokotsa D. Tsiavos D. Stavrakakis G.S. Kalaitzakis K. Antonidakis E. *Advanced fuzzy logic controllers designs' occupants thermal-visual comfort and indoor air quality satisfaction.* Energy and Buildings 33 (2001) 531-543

Krarti 2005. Krarti, M., P. M. Erickson, et al.. "A simplified method to estimate energy savings of artificial lighting use from daylighting." *Building and Environment* 40(6): 747-754. (2005)

Köster 1990. *Daylight system assisted by indirect lighting*, German patent DE3906229, Appl. H. Köster, (1990)

Köster 1990. *Reflector system for room lighting*, German patent DE3916688, Appl. H. Köster, (1990)

Köster 1994. *Light guidance system for the illumination of an interior area*, US patent US5293305, Appl. H. Köster, (1994)

Köster 2004. H. Köster, *Dynamic Daylighting Architecture – basics, systems, projects*, Birkhäuser, 2004

Lee 1998. Lee, E.S. DiBartolomeo, D.L. Selkowitz, S.E. *Thermal and daylighting performance of an automated venetian blind and lighting system in full-scale private office.* Energy and buildings 29 (1998) 47-63

Littlefair 1991. P. J. Littlefair. *Site layout planning for daylight and sunlight. A guide to good practice.* Building Research Establishment, Garston, Watford, 1991

Löfberg 1987. H. A. Löfberg. *Räkna med dagsljus.* Statens institut för byggnadsforskning. Gävle 1987

- Mathisen 2009.** Hans Martin Mathisen m fl 2009. *Highly efficient building services systems*. ZEB 2009
- Matusiak 1998.** B. Matusiak. *Daylighting in linear atrium buildings at high latitudes*. Dr. ing thesis, Department of Building technology, NTNU, September 1998
- Mingozi 2001.** Mingozi A., and Casalone R., *An innovative system for daylight collecting and transport for long distances and mixing with artificial light coming from hollow light guides*, LUX Europa, the 9th European Lighting Conference, Reykjavik, Iceland, June 2001
- Nagel 1998.** Nagel T., and Susemihl I., *Raumbeleuchtungsanordnung*, European patent EP0831272 (1998)
- Planning and Building Act 1986.** *The Planning and Building Act*. ISBN 82-504-1434-9. Miljøverndepartementet, Oslo 1986
- Ruck 2000.** N. Ruck with Ø. Aschehoug, S. Aydinli, J. Christoffersen, G. Courret, I. Edmonds, R. Jakobiak, M. Kischkoweit-Lopin, M. Klinger, E. Lee, L. Michel, J. Scartezzini, and S. Selkowitz, *Daylight in Buildings – a source book on daylighting systems and components*, IEA, 2000
- Sala 1996.** Sala, Marco *New Fasade technologies: AIW-Active Intelligent Window*. Renewable Energy, Vol. 10. No. 2/3 pp. 185-190. 1996
- Scartezzini 2002.** J. Scartezzini and G. Courret, *Anidolic Daylighting Systems*, Solar Energy Vol. 73, No. 2, pp. 123-135, 2002
- Schnetz 1996.** Schnetz H., *Triple component room lighting system*, German patent DE4439507, Appl. H. Schnetz, (1996)
- Seung-Ho 2002.** Seung-Ho Y., Lee E-T *Efficiency characteristic of building integrated photovoltaics as a shading device* Building and environment 37 (2002) 615-623
- SIS 1988.** Swedish Standard SIS 914201. *Byggnadsutforming – Dagsljus – Förenklad metod för kontroll av erforderlig fönsterglasarea*. Sverige 1988
- SunOrb 1997.** *SunOrb 1.0*. M. Skiba, C. Baresch and H. Unger. NES, Department for Nuclear and New Energy Systems, Ruhr-Universität Bochum, Germany 1997
- Technical regulations 1997.** *Teknisk forskrift til plan- og bygningsloven 1997*. Technical Regulations under the Planning and Building Act 1997. Kommunal- og arbeidsdepartementet. Bolig- og bygningsavdelingen, Norge 1997
- Technical regulation, guidance 2007.** *Guidance to Technical Regulations under the Planning and Building Act 1997*. Kommunal- og arbeidsdepartementet. Bolig- og bygningsavdelingen. 4. utgave mars 2007
- Vartiainen 2001.** Vartiainen, E. *Electricity benefits of daylighting and photovoltaics for various solar façade layouts in office buildings* Energy and Buildings 33 (2001) 113-120
- Vartiainen 2000.** Vartiainen, E. Peippo, K. Lund, P. *Daylight optimization of multifunctional solar facades*. Solar Energy Vol. 68, No. 3, pp 223-235 (2000)
- Velds 2002.** Velds, M. . *User acceptance studies to evaluate discomfort glare in daylight rooms*. Solar energy, Volume 73, Issue 2, August 2002, p 95-103 (2002)
- Vine 1998.** Vine, E. Lee, E.S. Clear, R. DiBartolomeo, D.L, Selkowitz, S.E. *Office worker response to an automated venetian blind and electric lighting system: a pilot study* Energy and Buildings 28

(1998) 205-218

Weitch 2003. Weitch, J. CIE report *Principles of Healthy Lighting* 2003

Whitehead 2009. Whitehead, L., Upward, A., Friedel P., Mossman M. Huizinga J., Simpson T. *Using Core Sunlighting to Improve Office Illumination*, Experiencing Light 2009, 26-27 October, Proceedings, Eindhoven, Nederland, 2009.

A world where buildings do not contribute with greenhouse gas emissions

The Research Centre on Zero emission Buildings (ZEB)

The main objective of ZEB is to develop competitive products and solutions for existing and new buildings that will lead to market penetration of buildings that have zero emissions of greenhouse gases related to their production, operation and demolition. The Centre will encompass both residential and commercial buildings, as well as public buildings.

ZEB

The Research Centre on Zero Emission Buildings



Partners

NTNU

www.ntnu.no

SINTEF

www.sintef.no

Skanska

www.skanska.no

Weber (Maxit)

www.maxit.no

Isola

www.isola.no

Glava

www.glava.no

Protan

www.protan.no

Hydro Aluminium

www.hydro.com

YIT

www.yit.no

ByBo

www.bybo.no

Multiconsult

www.multiconsult.no

Brødrene Dahl

www.dahl.no

Snohetta

www.snoarc.no

Forsvarsbygg

www.forsvarsbygg.no

Statsbygg

www.statsbygg.no

Husbanken

www.husbanken.no

Byggenæringens Landsforening

www.bnl.no

Norsk Teknologi

www.norskteknologi.no

Statens bygningstekniske etat

www.be.no

DuPont

www2.dupont.com

NorDan AS

www.nordan.no